

## **EGAT's Privacy Notice on Procurement, Inventory Management and Contract Administration**

Electricity Generating Authority of Thailand (EGAT) has performed the protection of the Personal Data regarding procurement, inventory management and contract administration to be in accordance with the **Personal Data Protection Act B.E. 2562** (the "2019 PDPA"), which comes into effect on June 1, 2022.

Details about EGAT's Privacy Notice on Procurement, Inventory Management and Contract Administration are available for you at [https://www.egat.co.th/privacy-notice-procurement\\_en.html](https://www.egat.co.th/privacy-notice-procurement_en.html) or the below QR Code.



## **The Redaction of Sensitive Personal Data**

EGAT has announced the Privacy Notice on Procurement, Inventory Management and Contract Administration for the collection, use or disclosure of Personal Data, excluding the Sensitive Personal Data.

Should the documents you wish to submit to EGAT contain the Sensitive Personal Data as defined in Section 26 of the 2019 PDPA, pertaining to racial, ethnic origin, political opinions, cult, religious or philosophical beliefs, sexual behavior, criminal records, health data, disability, trade union information, genetic data, biometric data, or of any data which may affect you in the same manner, you shall redact or conceal such data before submitting to EGAT.

## ประกาศความเป็นส่วนตัว (Privacy Notice) สำหรับการจัดซื้อจัดจ้าง การบริหารพัสดุ และการบริหารสัญญาของ กฟผ.

การไฟฟ้าฝ่ายผลิตแห่งประเทศไทย (กฟผ.) ได้ดำเนินการคุ้มครองข้อมูลส่วนบุคคลสำหรับการจัดซื้อจัดจ้าง การบริหารพัสดุ และการบริหารสัญญา เพื่อให้เป็นไปตามพระราชบัญญัติคุ้มครองข้อมูลส่วนบุคคลของประเทศไทย พ.ศ. 2562 (PDPA) ซึ่งมีผลบังคับใช้อย่างครบถ้วน ตั้งแต่วันที่ 1 มิถุนายน 2565 ทั้งนี้ ท่านสามารถศึกษารายละเอียดประกาศความเป็นส่วนตัว (Privacy Notice) สำหรับการจัดซื้อจัดจ้าง การบริหารพัสดุ และการบริหารสัญญา ได้ที่ <https://www.egat.co.th/privacy-notice-procurement.html> หรือที่ QR Code ด้านล่าง



### การขิดฆ่าข้อมูลส่วนบุคคลอ่อนไหว

กฟผ. มีประกาศความเป็นส่วนตัว (Privacy Notice) สำหรับการจัดซื้อจัดจ้าง การบริหารพัสดุ และการบริหารสัญญา เพื่อใช้ในการเก็บรวบรวม ใช้ หรือเปิดเผย ข้อมูลส่วนบุคคล แต่ไม่เก็บข้อมูลส่วนบุคคลอ่อนไหว หากเอกสารของท่านที่ต้องส่งมอบให้ กฟผ. มีข้อมูลส่วนบุคคลอ่อนไหวตามที่ถูกบัญญัติไว้ในมาตรา 26 ของ PDPA ดังนี้ เชื้อชาติ เผ่าพันธุ์ ความคิดเห็นทางการเมือง ความเชื่อในลัทธิ ศาสนาหรือปรัชญา พฤติกรรมทางเพศ ประวัติอาชญากรรม ข้อมูลสุขภาพ ความพิการ ข้อมูลสหภาพแรงงาน ข้อมูลพันธุกรรม ข้อมูลชีวภาพ หรือข้อมูลอื่นใด ซึ่งกระทบต่อเจ้าของข้อมูลส่วนบุคคลในทำนองเดียวกันรวมอยู่ด้วย ขอให้ท่านขิดฆ่า หรือปกปิดข้อมูลดังกล่าว ก่อนส่งมอบให้แก่ กฟผ.

## Notice to Bidder

### Subject : Online Payment for Purchase of Bidding Documents

Due to the outbreak of COVID-19 in Thailand, please be informed of the online payment for purchase of bidding documents as follows:

- 1) Payment shall be made by bank transfer or telegraphic transfer to EGAT's account no. 109-6-01958-2 (swift code : KRTHTHBK), Krung Thai Bank Public Company Limited, Bangkruai Branch, Nonthaburi.

All bank charges and fees incurred by the payment of bidding documents shall be under the buyer's responsibility.

- 2) Download the Registration Form and fill out all necessary information by typing. (Complete data is required.)
- 3) Submit the fill-out Registration Form and the proof of payment from 1) to the email address of the in-charge officer and [procurement.tse@egat.co.th](mailto:procurement.tse@egat.co.th) in the CC. before 15.00 hrs. Bangkok Standard Time.
- 4) After the payment has been verified for approximately 3 working days, the in-charge officer will send the link for downloading the bidding documents together with the receipt to the purchaser's email address in the Registration Form.

***\*\* Please note that this online payment process is a temporary measure due to the COVID-19 outbreak. The online payment process will be available until further notice from EGAT \*\****

\*\*\*\*\*

# Registration Form

Invitation to Bid No. RTS2-S-09

Supply and Construction of 230/115 kV Bhumibol Substation (GIS) and Improvement of  
230 kV Bhumibol Dam Power Plant Switchyard and 230 kV Tak 2 Substation

Transmission System Expansion and Renovation Project Phase 2

Fire Protection System Phase 3

Two-Envelope

Available Duration for Purchasing : September 28, 2022 - October 28, 2022

Price of Bidding Documents : USD 500.- or THB 15,000.-

## Instructions

- 1) Payment shall be made by bank transfer or telegraphic transfer to EGAT's account no. 109-6-01958-2 (swift code : KRTHTHBK), Krung Thai Bank Public Company Limited, Bangkrui Branch, Nonthaburi.
- 2) Fill out this Registration Form in English by typing. (Complete data is required.)
- 3) Submit the filled-out Registration Form and the proof of payment to the in-charge officer via email (with cc. procurement.tse@egat.co.th) before 15.00 hrs. Bangkok Standard Time.
- 4) The in-charge officer will send the link for downloading the bidding documents together with the receipt to the purchaser's email address in the Registration Form, which will take approximately 3 working days.

For Purchaser		TAX ID :	
No.	Receipt No. :	Date :	
Bidder's Name			
Address			
		Country :	
Name of Contact Person :		Tel.	Mobile No.
Email Address :			
Local Representative			
Address			
		Tax ID :	
Name of Contact Person :		Tel.	Mobile No.
Email Address :			
For Procurement Officer		Change of Bidder's Name	TAX ID :
Bidder's Letter No. :		Dated :	
New Bidder's Name			
Address			
		Country :	
Name of Contact Person :		Tel.	Mobile No.
Email Address :			
<b>Contact Information of In-charge Officer</b>			
Name	Mr. Thana Kirdboonsong		
Email address	thana.kir@egat.co.th		
Telephone No.	66 2436 3342		
Mobile No.	66 87116 3690		



Invitation to Bid No. RTS2-S-09

(Revision 4)

**Supply and Construction of 230/115 kV Bhumibol Substation (GIS) and Improvement of  
230 kV Bhumibol Dam Power Plant Switchyard and 230 kV Tak 2 Substation**

**Transmission System Expansion and Renovation Project Phase 2**

**Fire Protection System Phase 3**

**Two-Envelope**

The Electricity Generating Authority of Thailand (EGAT) is calling for the subject Invitation to Bid to be financed by EGAT's fund. The escalation factor (K) for price adjustment is applied to this Bid.

**Place of Construction** : Bhumibol Substation, Bhumibol Dam Power Plant Switchyard and Tak 2 Substation

**Medium Cost (including Value Added Tax and other expenses)** : THB 1,300,000,000.-

**Eligibility of Bidders**

1. The Bidder shall be a juristic person who provides such services and shall not be named in the List of Work Abandoners published by the Permanent Secretary, Ministry of Finance, and/or in the Debarment List and/or in the List of Work Abandoners declared by EGAT.
2. The Bidder shall not be a Jointly Interested Bidder with other Bidders as from the date of EGAT's issuance of the Invitation, or shall not be a person who undertakes any action as an "Obstruction of Fair Price Competition" for this Invitation.
3. The Bidder shall not either be EGAT's consultant or involve in EGAT's consultancy company under this Invitation to Bid, or shall not have EGAT's personnel involved in his business as shareholder having voting right that can control his business, director, manager, officer, employee, agent, or consultant except those who are officially ordered by EGAT to act or participate therein.
4. The Bidder shall not be the person who is privileged or protected not to be taken any legal proceedings under Thai Court; Provided that such Bidder's government declares that such special privilege is waived.
5. The Bidder who is a joint venture or consortium shall carry out all the work under such formation from the time of bidding until the fulfillment of the Contract.

**Availability of Bidding Documents**

Bidding Documents in CD-ROM will be available for examination of Bidder's Qualifications and purchase during 08:00 hrs. to 15:00 hrs., Bangkok Standard Time, as from September 28, 2022 to October 28, 2022 at USD 500.- or THB 15,000.- per copy, non-refundable, at the following address :

International Procurement Department - Transmission Segment  
(Room No. 301, 3<sup>rd</sup> Floor, Tor 082 Building)  
Procurement and Inventory Management Division  
Electricity Generating Authority of Thailand  
Bangkruai, Nonthaburi 11130, Thailand  
Telephone no. 66 2436 0342  
E-mail : [procurement.tse@egat.co.th](mailto:procurement.tse@egat.co.th)

Please find more details and download Registration Form for purchasing Bidding Documents at <http://www4.egat.co.th/fprocurement/biddingeng/>.

Payment can be made by a certified cheque or money order payable to EGAT or by a telegraphic transfer to EGAT's current account no. 109-6-01958-2 (swift code : KRTHTHBK), Krung Thai Bank Public Company Limited, Bangkruai Branch, Nonthaburi. All bank charges and fees incurred by the payment of bidding documents shall be under the buyer's responsibility.

*Chattiya C.*

Bidding Documents in CD-ROM will be either airmailed or airfreighted to the buyer at EGAT's expense upon receipt of the relevant remittance. In case the buyer requires the Bidding Documents to be sent by Express Mail Service (EMS), the charge will be at the buyer's expense.

Delivery of Bids

*Price and Technical Proposal Submission Date and Technical Proposal Opening Date is postponed from November 15, 2022 to November 29, 2022. Price and Technical Proposals shall be submitted at Bidding Room, 1<sup>st</sup> Floor, Tor 082 Building during 09:30 hrs. to 10:00 hrs., Bangkok Standard Time, and Technical Proposal will be opened publicly at 10:00 hrs.*

ELECTRICITY GENERATING AUTHORITY OF THAILAND

*November 15, 2022*

A handwritten signature in blue ink that reads "Chattiya C." in a cursive style.

(Miss Chattiya Chandhanayingyong)

Chief, International Procurement Department - Transmission Segment



## ประกาศการไฟฟ้าฝ่ายผลิตแห่งประเทศไทย

(ฉบับแก้ไข ครั้งที่ 4)

### เรื่อง ประกวดราคาจ้าง เลขที่ RTS2-S-09

#### ประกวดราคา 2 ของ

การไฟฟ้าฝ่ายผลิตแห่งประเทศไทย (กฟผ.) มีความประสงค์จะจัดหาและจ้างก่อสร้างสถานีไฟฟ้าแรงสูง 230/115 kV ภูมิพล (GIS) และจัดหาและจ้างก่อสร้างปรับปรุงลานไก 230 kV โรงไฟฟ้าพลังน้ำเขื่อนภูมิพลและสถานีไฟฟ้าแรงสูง 230 kV ตาก 2 สำหรับโครงการปรับปรุงและขยายระบบส่งไฟฟ้าที่เสื่อมสภาพตามอายุการใช้งานระยะที่ 2 และแผนงานติดตั้งระบบดับเพลิงสถานีไฟฟ้าแรงสูง ระยะที่ 3 โดยทำสัญญาแบบปรับราคาได้ (ค่า k) โดยใช้งบประมาณ กฟผ.

**สถานที่ก่อสร้าง :** สถานีไฟฟ้าแรงสูงภูมิพล ลานไกโรงไฟฟ้าพลังน้ำเขื่อนภูมิพล และสถานีไฟฟ้าแรงสูงตาก 2

**ราคากลาง (รวมภาษีมูลค่าเพิ่มและค่าใช้จ่ายอื่นๆ) :** 1,300,000,000.- บาท

#### คุณสมบัติของผู้เสนอราคา

1. ต้องเป็นนิติบุคคลผู้มีอาชีพรับจ้างตามประกวดราคาจ้างดังกล่าว และต้องไม่เป็นผู้ทำงานซึ่งปลัดกระทรวงการคลังได้แจ้งเวียนชื่อไว้ หรือต้องไม่เป็นผู้ที่ กฟผ. ห้ามติดต่อหรือห้ามเข้าเสนอราคา หรือต้องไม่เป็นผู้ที่ได้รับผลของการสั่งให้นิติบุคคลหรือบุคคลอื่นเป็นผู้ทำงานตามคำสั่ง กฟผ.
2. ต้องไม่เป็นผู้มีผลประโยชน์ร่วมกันกับผู้เสนอราคารายอื่น ณ วันประกาศประกวดราคาครั้งนี้เป็นต้นไป หรือต้องไม่เป็นผู้กระทำการอันเป็นการขัดขวางการแข่งขันราคาอย่างเป็นธรรมในการดำเนินการประกวดราคาครั้งนี้
3. ต้องไม่เป็นที่ปรึกษาของ กฟผ. หรือมีส่วนร่วมในบริษัทที่ปรึกษาของ กฟผ. ในงานนี้ หรือต้องไม่มีผู้ปฏิบัติงาน กฟผ. เข้าไปมีส่วนร่วมในกิจการของผู้เสนอราคา ไม่ว่าจะในฐานะผู้ถือหุ้นที่มีสิทธิควบคุมการจัดการ กรรมการ ผู้อำนวยการ ผู้จัดการ พนักงาน ลูกจ้าง ตัวแทน หรือที่ปรึกษา ยกเว้น ในกรณีที่ผู้ปฏิบัติงานได้รับคำสั่งอย่างเป็นทางการจาก กฟผ. ให้ไปปฏิบัติงานหรือเข้าร่วมในกิจการของผู้เสนอราคา
4. ต้องไม่เป็นผู้ได้รับเอกสิทธิ์หรือความคุ้มกัน ซึ่งอาจปฏิเสธไม่ยอมขึ้นศาลไทย เว้นแต่รัฐบาลของผู้เสนอราคาได้มีคำสั่งให้สละสิทธิ์และความคุ้มกันเช่นนั้น
5. ผู้ประสงค์เข้าประกวดราคาในนามของกิจการร่วมค้าหรือกิจการค้าร่วม (Joint Venture or Consortium) จะต้องดำเนินการทุกขั้นตอนของการประกวดราคาในนามของกิจการร่วมค้าหรือกิจการค้าร่วม ตั้งแต่การเสนอราคาจนถึงสิ้นสุดข้อผูกพันกับ กฟผ.

#### การขายเอกสารประกวดราคา

ผู้สนใจติดต่อขอทราบรายละเอียด เพื่อตรวจสอบคุณสมบัติของผู้เสนอราคา และขอซื้อเอกสารประกวดราคา ในราคาชุดละ 15,000.- ได้ที่ แผนกจัดจ้างต่างประเทศสายงานระบบส่ง (ห้อง 301 ชั้น 3 อาคารฝ่ายจัดซื้อจัดจ้างและบริหารพัสดุ ท.082) กองจัดซื้อจัดจ้างต่างประเทศสายงานระบบส่ง ฝ่ายจัดซื้อจัดจ้างและบริหารพัสดุ การไฟฟ้าฝ่ายผลิตแห่งประเทศไทย เชียงสะพานพระราม 7 จังหวัดนนทบุรี ในวันทำการระหว่างเวลา 08:00 น. ถึง 15:00 น. ตั้งแต่วันที่ 28 กันยายน 2565 ถึงวันที่ 28 ตุลาคม 2565 หรือสอบถามทางโทรศัพท์ หมายเลข 0 2436 0342 หรืออีเมล procurement.tse@egat.co.th ทั้งนี้ สามารถ download แบบฟอร์มลงทะเบียนผู้ซื้อเอกสารประกวดราคาได้ที่เว็บไซต์ <http://www4.egat.co.th/fprocurement/biddingeng/>

การยื่นซองประกวดราคา

กำหนดยื่นซองข้อเสนอด้านเทคนิคพร้อมซองราคา เลื่อนจากวันที่ 15 พฤศจิกายน 2565 เป็นวันที่ 29 พฤศจิกายน 2565 เวลา 09:30 น. ถึง 10:00 น. และเปิดซองข้อเสนอด้านเทคนิคเวลา 10:00 น. ณ ห้องประกวดราคา ชั้น 1 อาคารฝ่ายจัดซื้อจัดจ้างและบริหารพัสดุ ท.082 การไฟฟ้าฝ่ายผลิตแห่งประเทศไทย เขตสะพานพระราม 7 จังหวัดนนทบุรี

ประกาศ ณ วันที่ 15 พฤศจิกายน 2565



(นางสาวฉัตรติยา จันทนยิ่งยง)

หัวหน้ากองจัดซื้อจัดจ้างต่างประเทศสายงานระบบส่ง



**ตารางแสดงวงเงินงบประมาณที่ได้รับจัดสรรและราคากลาง(ราคาอ้างอิง)  
ในการจัดซื้อจัดจ้างที่มีใช้งานก่อสร้าง**

**1. ชื่อโครงการ Bid No. RTS2-S-09**

งานจัดหาและจ้างก่อสร้างสถานีไฟฟ้าแรงสูง 230/115 kV ภูมิพล (GIS)  
และจัดหาและจ้างก่อสร้างปรับปรุงลานไก 230 kV โรงไฟฟ้าพลังน้ำเขื่อนภูมิพล  
และสถานีไฟฟ้าแรงสูง 230 kV ตาก 2

โครงการปรับปรุงและขยายระบบส่งไฟฟ้าที่เสื่อมสภาพตามอายุการใช้งานระยะที่ 2  
แผนงานติดตั้งระบบดับเพลิงสถานีไฟฟ้าแรงสูง ระยะที่ 3

/หน่วยงานเจ้าของโครงการ ฝ่ายแผนงานและโครงการระบบส่ง การไฟฟ้าฝ่ายผลิตแห่งประเทศไทย

**2. วงเงินงบประมาณที่ได้รับจัดสรร**

โครงการปรับปรุงและขยายระบบส่งไฟฟ้าที่เสื่อมสภาพตามอายุการใช้งานระยะที่ 2

งบประมาณ 21,900 ล้านบาท

แผนงานติดตั้งระบบดับเพลิงสถานีไฟฟ้าแรงสูง ระยะที่ 3 งบประมาณ 1,274.22 ล้านบาท

**3. วันที่กำหนดราคากลาง 31 สิงหาคม 2565 (วันที่ รวส. อนุมัติ )**

ราคารวมภาษีมูลค่าเพิ่มและค่าใช้จ่ายอื่นๆ เป็นเงิน 1,300,000,000.00 บาท ราคา/หน่วย ตามเอกสารแนบ

**4. แหล่งที่มาของราคากลาง**

หลักเกณฑ์การกำหนดราคากลางการจัดซื้อและจัดจ้างงานก่อสร้างระบบส่งไฟฟ้าของสายงานระบบส่ง

**5. รายชื่อเจ้าหน้าที่ผู้กำหนดราคากลาง**

5.1 นายฉัตรชัย                      เชาวนาธิคม                      หมฟ-ส. กวอ-ส.

5.2 นายธิติวัดน์                      เบญจวงค์รัตน์                      หสก-ส. กวอ-ส.

5.3 นายภาณุวัฒน์                      ลิขิตผลผดุง                      หอต-ส. กวอ-ส.

5.4 นางสาวจรรุวรรณ                      พิพัฒน์มงคลพร                      หวอ-ส. กวอ-ส.

5.5 นายเมธา                      รักปาน                      กวป-ส.

5.6 นายสุวัฒน์                      ศักดิ์สมกุลอุทัย                      กวธ-ส.

5.7 นางสาวเอกอุหาร                      เทวารุฑ                      กวส-ส. อรส.

**หมายเหตุ** ค่าใช้จ่ายอื่นๆ ได้แก่ ค่าใช้จ่ายที่ กพผ. ต้องจ่ายตามวิธีการพิจารณาเปรียบเทียบราคาที่กำหนดไว้ในเอกสารประกวดราคา เช่น อากรขาเข้า เป็นต้น

*นางสาวอัสยา*

**นางสาวอัสยา ช่างวิทยากา  
ทจตส-ท.**

**21 ก.ย. 2565**

**MEDIUM COST FOR BID NO. RTS2-S-09**

**SUMMARY OF BID PRICE**

**SUPPLY AND CONSTRUCTION OF 230/115 KV BHUMIBOL SUBSTATION (GIS) AND IMPROVEMENT OF 230 KV BHUMIBOL DAM POWER PLANT SWITCHYARD AND 230 KV TAK 2 SUBSTATION TRANSMISSION SYSTEM EXPANSION AND RENOVATION PROJECT PHASE 2  
 FIRE PROTECTION SYSTEM PHASE 3**

Schedule	Description	Currency	Supply of Equipment		Local Currency (excluding VAT) Baht Amount	Local Transportation (excluding VAT) Baht Amount	Local Transportation, Construction and Installation (excluding VAT) Baht Amount
			Foreign Supply	Local Supply			
			CIF Thai Port	Ex-works Price (excluding VAT) Baht			
			Amount	Amount			
1	230 KV BHUMIBOL SUBSTATION (GIS)	THB	369,991,244.16				
				143,333,604.38	220,244,367.64	917,409.08	75,043,482.54
2	115 KV BHUMIBOL SUBSTATION (GIS)	THB	196,049,988.86				
				85,538,533.92	4,260,197.72	255,401.35	49,453,898.60
3	230/115 KV BHUMIBOL SUBSTATION (GIS) (FIRE PROTECTION SYSTEM PHASE 3)				44,025,486.80		
4	230 KV BHUMIBOL DAM POWER PLANT SWITCHYARD						
				7,960,488.00		74,916.00	1,657,696.14
5	230 KV TAK 2 SUBSTATION						
				2,428,034.00		37,458.00	357,670.01

  
 นางสุตารัตน์ ไชยพันธุ์  
 ผู้อำนวยการฝ่ายวิศวกรรมระบบส่ง

31 Aug 2022

**MEDIUM COST FOR BID NO. RTS2-S-09**

**SUMMARY OF BID PRICE**

**SUPPLY AND CONSTRUCTION OF 230/115 KV BHUMIBOL SUBSTATION (GIS) AND IMPROVEMENT OF 230 KV BHUMIBOL DAM POWER PLANT SWITCHYARD AND 230 KV  
 TAK 2 SUBSTATION  
 TRANSMISSION SYSTEM EXPANSION AND RENOVATION PROJECT PHASE 2  
 FIRE PROTECTION SYSTEM PHASE 3**

Schedule	Description	Currency	Supply of Equipment		Local Currency (excluding VAT) Baht	Local Transportation (excluding VAT) Baht	Local Transportation, Construction and Installation (excluding VAT) Baht			
			Foreign Supply	Local Supply						
			CIF Thai Port	Ex-works Price (excluding VAT) Baht						
			Amount	Amount						
<b>BID PRICE</b>	<b>THB</b>	<b>566,041,233.02</b>	<b>Baht</b>	<b>239,260,660.30</b>	<b>Baht</b>	<b>268,530,052.16</b>	<b>Baht</b>	<b>1,285,184.43</b>	<b>Baht</b>	<b>126,512,747.29</b>
<b>OTHER EXPENSES</b>	<b>THB</b>	<b>11,320,824.66</b>								
<b>VAT</b>	<b>THB</b>	<b>40,415,344.04</b>	<b>Baht</b>	<b>16,748,246.22</b>	<b>Baht</b>	<b>18,797,103.65</b>	<b>Baht</b>	<b>89,962.91</b>	<b>Baht</b>	<b>8,855,892.31</b>
<b>SUMMARY OF BID PRICE</b>	<b>THB</b>	<b>617,777,401.72</b>	<b>Baht</b>	<b>256,008,906.52</b>	<b>Baht</b>	<b>287,327,155.81</b>	<b>Baht</b>	<b>1,375,147.34</b>	<b>Baht</b>	<b>135,368,639.60</b>
<b>TOTAL MEDIUM COST</b>	<b>THB</b>	<b>1,297,857,250.99</b>								
<b>TOTAL MEDIUM COST (ROUND)</b>	<b>THB</b>	<b>1,300,000,000.00</b>								

  
 นางสุดารัตน์ ไชยพันธุ์  
 ผู้อำนวยการฝ่ายวิศวกรรมระบบส่ง

นางสาวอวยษา ช่างวิทยากา  
 หจคส-ท.  
 21 ก.ย. 2565

**MEDIUM COST FOR BID NO. RTS2-S-09**  
**SCHEDULE 1 : 230 KV BHUMIBOL SUBSTATION (GIS)**  
**SUPPLY AND CONSTRUCTION OF 230 KV BHUMIBOL SUBSTATION (GIS)**  
**TRANSMISSION SYSTEM EXPANSION AND RENOVATION PROJECT PHASE 2**

Description	Currency	Supply of Equipment		Local Currency (excluding VAT) Baht Amount	Local Transportation (excluding VAT) Baht Amount	Local Transportation, Construction and Installation (excluding VAT) Baht Amount
		Foreign Supply	Local Supply			
		CIF Thai Port	Ex-works Price (excluding VAT) Baht			
		Amount	Amount			
PART 1AB : SUPPLY AND INSTALLATION OF SUBSTATION EQUIPMENT	THB	369,225,817.76	126,194,909.38			75,043,482.54
PART 1C : CIVIL WORK				220,244,367.64		
PART 1D : SUPPLY OF SPARE PARTS	THB	765,426.40	14,414,116.00		781,182.08	
PART 1E : WORK ON SUPPLY EQUIPMENT BASIS			2,724,579.00		136,227.00	
<b>TOTAL PRICE</b>	<b>THB</b>	<b>369,991,244.16</b>	<b>Baht 143,333,604.38</b>	<b>Baht 220,244,367.64</b>	<b>Baht 917,409.08</b>	<b>Baht 75,043,482.54</b>



นางสุตารัตน์ ไชยพันธุ์  
 ผู้อำนวยการฝ่ายวิศวกรรมระบบส่ง

31 Aug 2022

**MEDIUM COST FOR BID NO. RTS2-S-09**  
**PART 1AB : SUPPLY AND INSTALLATION OF SUBSTATION EQUIPMENT**  
**SUPPLY AND CONSTRUCTION OF 230 KV BHUMIBOL SUBSTATION (GIS)**  
**TRANSMISSION SYSTEM EXPANSION AND RENOVATION PROJECT PHASE 2**

Description	Currency	Supply of Equipment		Local Transportation, Construction and Installation ( excluding VAT ) Baht Amount
		Foreign Supply	Local Supply	
		CIF Thai Port	Ex-works Price ( excluding VAT ) Baht	
		Amount	Amount	
Schedule 1AB1 : Power Transformer and Marshalling Control Cubicle	THB		220,000.00	33,000.00
Schedule 1AB2 : Distribution Transformer	THB		1,798,000.00	269,700.00
Schedule 1AB6 : Coupling Capacitor Voltage Transformer, Coupling Capacitor, Voltage Transformer and Junction Box	THB		700,000.00	105,000.00
Schedule 1AB7 : SF6 Gas Insulated Switchgear	THB	363,932,688.00		54,589,903.20

  
นางสุตารัตน์ ไชยพันธุ์  
ผู้อำนวยการฝ่ายวิศวกรรมระบบส่ง

31 Aug 2022

  
นางสาวอัสยา ช่างวิทยากา  
หงตส-ท.  
21 ก.ย. 2565

**MEDIUM COST FOR BID NO. RTS2-S-09**  
**PART 1AB : SUPPLY AND INSTALLATION OF SUBSTATION EQUIPMENT**  
**SUPPLY AND CONSTRUCTION OF 230 KV BHUMIBOL SUBSTATION (GIS)**  
**TRANSMISSION SYSTEM EXPANSION AND RENOVATION PROJECT PHASE 2**

Description	Currency	Supply of Equipment		Local Transportation, Construction and Installation ( excluding VAT ) Baht Amount
		Foreign Supply	Local Supply	
		CIF Thai Port	Ex-works Price ( excluding VAT ) Baht	
		Amount	Amount	
Schedule 1AB11 : Power Fuse, Fuse Link and Hook Stick	THB	1,061,010.50		159,151.58
Schedule 1AB12 : AC&DC Distribution Board and Termination Box			4,957,399.00	743,609.85
Schedule 1AB13 : Stationary Battery and Battery Charger	THB	3,013,008.00	2,022,900.00	755,386.20
Schedule 1AB14 : Substation Steel Structure			5,617,959.00	2,106,734.63

  
 นางสุตารัตน์ ไชยพันธุ์  
 ผู้อำนวยการฝ่ายวิศวกรรมระบบส่ง

31 Aug 2022

  
 นางสาวอัสยา ช่างวิทยากร  
 หจกส-ท.  
 21 ก.ย. 2565

**MEDIUM COST FOR BID NO. RTS2-S-09**  
**PART 1AB : SUPPLY AND INSTALLATION OF SUBSTATION EQUIPMENT**  
**SUPPLY AND CONSTRUCTION OF 230 KV BHUMIBOL SUBSTATION (GIS)**  
**TRANSMISSION SYSTEM EXPANSION AND RENOVATION PROJECT PHASE 2**

Description	Currency	Supply of Equipment		Local Transportation, Construction and Installation ( excluding VAT ) Baht Amount
		Foreign Supply	Local Supply	
		CIF Thai Port	Ex-works Price ( excluding VAT ) Baht	
		Amount	Amount	
Schedule 1AB15 : Insulator				70,656.30
Schedule 1AB16 : Cable Terminations	THB	228,681.20		85,755.45
Schedule 1AB17 : XLPE Power Cable			119,900.00	44,962.50
Schedule 1AB18 : Low Voltage Cable and Conductor			9,221,147.10	3,457,930.16

  
 นางสาวสุดารัตน์ ไชยพันธุ์  
 ผู้อำนวยการฝ่ายวิศวกรรมระบบส่ง

31 Aug 2022

  
 นางสาวอาสยา ช่างวิทยากาส  
 หมดส.พ.  
 21 ก.ย. 2565

**MEDIUM COST FOR BID NO. RTS2-S-09**  
**PART 1AB : SUPPLY AND INSTALLATION OF SUBSTATION EQUIPMENT**  
**SUPPLY AND CONSTRUCTION OF 230 KV BHUMIBOL SUBSTATION (GIS)**  
**TRANSMISSION SYSTEM EXPANSION AND RENOVATION PROJECT PHASE 2**

Description	Currency	Supply of Equipment		Local Transportation, Construction and Installation ( excluding VAT ) Baht Amount
		Foreign Supply	Local Supply	
		CIF Thai Port	Ex-works Price ( excluding VAT ) Baht	
		Amount	Amount	
Schedule 1AB19 : Switchyard Lighting Fixtures			667,714.00	250,392.75
Schedule 1AB20 : Aluminum Tube, Connector and Miscellaneous Hardware			94,730.92	35,524.10
Schedule 1AB21 : Bus Fitting	THB	105,930.79		39,724.05
Schedule 1AB22 : Grounding Material	THB	819,694.97	427,262.56	467,609.07

  
นางสุตารัตน์ ไชยพันธุ์  
ผู้อำนวยการฝ่ายวิศวกรรมระบบส่ง

31 Aug 2022

  
นางสาวอาสยา ช่างวิทยากา  
ทจตส-ท.  
21 ก.ย. 2565



**MEDIUM COST FOR BID NO. RTS2-S-09**  
**PART 1AB : SUPPLY AND INSTALLATION OF SUBSTATION EQUIPMENT**  
**SUPPLY AND CONSTRUCTION OF 230 KV BHUMIBOL SUBSTATION (GIS)**  
**TRANSMISSION SYSTEM EXPANSION AND RENOVATION PROJECT PHASE 2**

Description	Currency	Supply of Equipment		Local Transportation, Construction and Installation ( excluding VAT ) Baht Amount
		Foreign Supply	Local Supply	
		CIF Thai Port	Ex-works Price ( excluding VAT ) Baht	
		Amount	Amount	
Schedule 1AB23 : Substation Miscellaneous	THB	64,804.30	189,397.80	95,325.79
Schedule 1AB24 : Control and Protection System			94,710,179.00	9,471,009.91
Schedule 1AB25 : Fault Recording System			3,769,770.00	376,977.00
Schedule 1AB34 : 48 VDC Stationary Battery, Battery Charger and DC Power			1,349,000.00	116,000.00

  
 นางสาวสุตารัตน์ ไชยพันธุ์  
 ผู้อำนวยการฝ่ายวิศวกรรมระบบส่ง

31 Aug 2022

  
 นางสาวอัสยา ช่างวิทยากร  
 พงศส-ท.  
 21 ก.ย. 2565

**MEDIUM COST FOR BID NO. RTS2-S-09**  
**PART 1AB : SUPPLY AND INSTALLATION OF SUBSTATION EQUIPMENT**  
**SUPPLY AND CONSTRUCTION OF 230 KV BHUMIBOL SUBSTATION (GIS)**  
**TRANSMISSION SYSTEM EXPANSION AND RENOVATION PROJECT PHASE 2**

Description	Currency	Supply of Equipment		Local Transportation, Construction and Installation ( excluding VAT ) Baht
		Foreign Supply	Local Supply	
		CIF Thai Port	Ex-works Price ( excluding VAT ) Baht	
		Amount	Amount	
Schedule 1AB35 : Communication Cable			329,550.00	569,130.00
Schedule 1AB39 : Commissioning				1,200,000.00
<b>PART 1AB</b>	<b>THB</b>	<b>369,225,817.76</b>	<b>Baht</b>	<b>Baht</b>
			<b>126,194,909.38</b>	<b>75,043,482.54</b>



นางสุดารัตน์ ไชยพันธุ์  
 ผู้อำนวยการฝ่ายวิศวกรรมระบบส่ง

31 Aug 2022

*นางสาวอัสยา ช่างวิทยากา*

นางสาวอัสยา ช่างวิทยากา  
 หมดศ-น.

21 ก.ย. 2565

**MEDIUM COST FOR BID NO. RTS2-S-09**  
**PART 1C : CIVIL WORK**  
**SUPPLY AND CONSTRUCTION OF 230 KV BHUMIBOL SUBSTATION (GIS)**  
**TRANSMISSION SYSTEM EXPANSION AND RENOVATION PROJECT PHASE 2**

Description	<b>Local Currency</b> ( excluding VAT ) Baht
	Amount
Schedule 1C1 : Foundation Work	3,396,692.00
Schedule 1C2 : Cable Trench	13,838,793.00
Schedule 1C3 : Building	170,680,334.13
Schedule 1C4 : Earth Work, Road and Crushed Rock Surfacing	7,211,279.00
Schedule 1C5 : Water Supply System	98,099.00
Schedule 1C6 : Drainage System	11,348,244.00
Schedule 1C7 : Special Construction Works	9,007,184.51
Schedule 1C8 : Miscellaneous	4,663,742.00
<b>PART 1C</b>	<b>Baht</b> <b>220,244,367.64</b>



นางสุตารัตน์ ไชยพันธุ์  
 ผู้อำนวยการฝ่ายวิศวกรรมระบบส่ง

31 Aug 2022

นางสาวอัสยา ช่างวิทยากร

นางสาวอัสยา ช่างวิทยากร  
 หจกส-ท.

21 ก.ย. 2565

**MEDIUM COST FOR BID NO. RTS2-S-09**  
**PART 1D : SUPPLY OF SPARE PARTS**  
**SUPPLY AND CONSTRUCTION OF 230 KV BHUMIBOL SUBSTATION (GIS)**  
**TRANSMISSION SYSTEM EXPANSION AND RENOVATION PROJECT PHASE 2**

Description	Currency	Supply of Equipment		Local Transportation ( excluding VAT ) Baht Amount
		Foreign Supply	Local Supply	
		CIF Thai Port	Ex-works Price ( excluding VAT ) Baht	
		Amount	Amount	
Schedule 1D7 : Spare Parts for SF6 Gas Insulated Switchgear	THB	688,840.00		51,663.00
Schedule 1D11 : Spare Parts for Power Fuse, Fuse Link and Hook Stick	THB	76,586.40		5,743.98
Schedule 1D12 : Spare Parts for AC&DC Distribution Board and Termination Box			123,228.00	9,242.10
Schedule 1D24 : Spare Parts for Control and Protection System			13,957,597.00	697,871.00

  
นางสุดารัตน์ ไชยพันธุ์  
ผู้อำนวยการฝ่ายวิศวกรรมระบบส่ง

31 Aug 2022

  
นางสาวอาสยา ช่างวิทยากษ  
ทจตส-ท.  
21 ก.ย. 2565

**MEDIUM COST FOR BID NO. RTS2-S-09**  
**PART 1D : SUPPLY OF SPARE PARTS**  
**SUPPLY AND CONSTRUCTION OF 230 KV BHUMIBOL SUBSTATION (GIS)**  
**TRANSMISSION SYSTEM EXPANSION AND RENOVATION PROJECT PHASE 2**

Description	Currency	Supply of Equipment		Local Transportation ( excluding VAT ) Baht Amount
		Foreign Supply	Local Supply	
		CIF Thai Port	Ex-works Price ( excluding VAT ) Baht	
		Amount	Amount	
Schedule 1D25 : Spare Parts for Fault Recording System			333,291.00	16,662.00
<b>PART 1D</b>	<b>THB</b>	<b>765,426.40</b>	<b>Baht</b> <b>14,414,116.00</b>	<b>Baht</b> <b>781,182.08</b>



นางสุตารัตน์ ไชยพันธุ์  
 ผู้อำนวยการฝ่ายวิศวกรรมระบบส่ง  
 31 Aug 2022

นางสาวอัสยา ช่างวิทยากร  
 หจกส-ท.  
 21 ก.ย. 2565

**MEDIUM COST FOR BID NO. RTS2-S-09**  
**PART 1E : WORK ON SUPPLY EQUIPMENT BASIS**  
**SUPPLY AND CONSTRUCTION OF 230 KV BHUMIBOL SUBSTATION (GIS)**  
**TRANSMISSION SYSTEM EXPANSION AND RENOVATION PROJECT PHASE 2**

Description	Currency	Supply of Equipment		Local Transportation ( excluding VAT ) Baht Amount
		Foreign Supply	Local Supply	
		CIF Thai Port	Ex-works Price ( excluding VAT ) Baht	
		Amount	Amount	
Schedule 1E24 : Control and Protection System			2,724,579.00	136,227.00
<b>PART 1E</b>			<b>Baht</b> 2,724,579.00	<b>Baht</b> 136,227.00



นางสุตารัตน์ ไชยพันธุ์  
 ผู้อำนวยการฝ่ายวิศวกรรมระบบส่ง

31 Aug 2022



นางสาวอาสยา ช่างวิทยากร  
 หจกส.ท.

21 ก.ย. 2565

อรุณ ชิงฉิมพาส  
นางสาวอรุณษา ช่างวิทยากร  
หจกส-ท.  
21 ก.ย. 2565

**MEDIUM COST FOR BID NO. RTS2-S-09**  
**SCHEDULE 2 : 115 KV BHUMIBOL SUBSTATION (GIS)**  
**SUPPLY AND CONSTRUCTION OF 115 KV BHUMIBOL SUBSTATION (GIS)**  
**TRANSMISSION SYSTEM EXPANSION AND RENOVATION PROJECT PHASE 2**

Description	Currency	Supply of Equipment		Local Currency (excluding VAT) Baht Amount	Local Transportation (excluding VAT) Baht Amount	Local Transportation, Construction and Installation (excluding VAT) Baht Amount
		Foreign Supply	Local Supply			
		CIF Thai Port	Ex-works Price (excluding VAT) Baht			
		Amount	Amount			
PART 2AB : SUPPLY AND INSTALLATION OF SUBSTATION EQUIPMENT	THB	194,460,997.66	82,813,954.92			49,453,898.60
PART 2C : CIVIL WORK				4,260,197.72		
PART 2D : SUPPLY OF SPARE PARTS	THB	1,588,991.20			119,174.35	
PART 2E : WORK ON SUPPLY EQUIPMENT BASIS			2,724,579.00		136,227.00	
<b>TOTAL PRICE</b>	<b>THB</b>	<b>196,049,988.86</b>	<b>Baht</b> 85,538,533.92	<b>Baht</b> 4,260,197.72	<b>Baht</b> 255,401.35	<b>Baht</b> 49,453,898.60

  
นางสุดารัตน์ ไชยพันธุ์  
ผู้อำนวยการฝ่ายวิศวกรรมระบบส่ง

31 Aug 2022

**MEDIUM COST FOR BID NO. RTS2-S-09**  
**PART 2AB : SUPPLY AND INSTALLATION OF SUBSTATION EQUIPMENT**  
**SUPPLY AND CONSTRUCTION OF 115 KV BHUMIBOL SUBSTATION (GIS)**  
**TRANSMISSION SYSTEM EXPANSION AND RENOVATION PROJECT PHASE 2**

Description	Currency	Supply of Equipment		Local Transportation, Construction and Installation ( excluding VAT ) Baht
		Foreign Supply	Local Supply	
		CIF Thai Port	Ex-works Price ( excluding VAT ) Baht	
		Amount	Amount	
Schedule 2AB1 : Power Transformer and Marshalling Control Cubicle	THB		220,000.00	33,000.00
Schedule 2AB4 : Surge Arresters	THB	2,022,000.00	495,000.00	377,550.00
Schedule 2AB6 : Coupling Capacitor Voltage Transformer, Coupling Capacitor, Voltage Transformer and Junction Box	THB	2,007,000.00	402,000.00	361,350.00



นางสุดารัตน์ ไชยพันธุ์  
 ผู้อำนวยการฝ่ายวิศวกรรมระบบส่ง

31 Aug 2022



นางสาวอาสยา ช่างวิทยากาน  
 ทดตส.ท.

21 ก.ย. 2565



**MEDIUM COST FOR BID NO. RTS2-S-09**  
**PART 2AB : SUPPLY AND INSTALLATION OF SUBSTATION EQUIPMENT**  
**SUPPLY AND CONSTRUCTION OF 115 KV BHUMIBOL SUBSTATION (GIS)**  
**TRANSMISSION SYSTEM EXPANSION AND RENOVATION PROJECT PHASE 2**

Description	Currency	Supply of Equipment		Local Transportation, Construction and Installation ( excluding VAT ) Baht
		Foreign Supply	Local Supply	
		CIF Thai Port	Ex-works Price ( excluding VAT ) Baht	
		Amount	Amount	
Schedule 2AB7 : SF6 Gas Insulated Switchgear	THB	154,461,880.00		23,169,282.00
Schedule 2AB10 : Disconnecting Switch	THB	1,334,988.00		200,248.20
Schedule 2AB11 : Power Fuse, Fuse Link and Hook Stick	THB	515,427.00		77,314.05
Schedule 2AB12 : AC&DC Distribution Board and Termination Box			1,197,971.00	179,695.65

  
 นางสาวสุตารัตน์ ไชยพันธุ์  
 ผู้อำนวยการฝ่ายวิศวกรรมระบบส่ง  
 31 Aug 2022

  
 นางสาวอาสยา ช่างวิทยากา  
 พจตส-ท.  
 21 ก.ย. 2565

**MEDIUM COST FOR BID NO. RTS2-S-09**  
**PART 2AB : SUPPLY AND INSTALLATION OF SUBSTATION EQUIPMENT**  
**SUPPLY AND CONSTRUCTION OF 115 KV BHUMIBOL SUBSTATION (GIS)**  
**TRANSMISSION SYSTEM EXPANSION AND RENOVATION PROJECT PHASE 2**

Description	Currency	Supply of Equipment		Local Transportation, Construction and Installation ( excluding VAT ) Baht
		Foreign Supply	Local Supply	
		CIF Thai Port	Ex-works Price ( excluding VAT ) Baht	
		Amount	Amount	
Schedule 2AB14 : Substation Steel Structure			2,288,132.00	858,049.50
Schedule 2AB15 : Insulator				49,369.65
Schedule 2AB16 : Cable Terminations	THB	21,240,452.20		7,965,169.58
Schedule 2AB17 : XLPE Power Cable			20,542,500.00	7,703,437.50



นางสุตารัตน์ ไชยพันธุ์  
 ผู้อำนวยการฝ่ายวิศวกรรมระบบส่ง

31 Aug 2022



นางสาวอาสยา ช่างวิทยากร

ทจตส-ท.

21 ก.ย. 2565

**MEDIUM COST FOR BID NO. RTS2-S-09**  
**PART 2AB : SUPPLY AND INSTALLATION OF SUBSTATION EQUIPMENT**  
**SUPPLY AND CONSTRUCTION OF 115 KV BHUMIBOL SUBSTATION (GIS)**  
**TRANSMISSION SYSTEM EXPANSION AND RENOVATION PROJECT PHASE 2**

Description	Currency	Supply of Equipment		Local Transportation, Construction and Installation ( excluding VAT ) Baht
		Foreign Supply	Local Supply	
		CIF Thai Port	Ex-works Price ( excluding VAT ) Baht	
		Amount	Amount	
Schedule 2AB18 : Low Voltage Cable and Conductor:			3,801,749.60	1,425,656.10
Schedule 2AB19 : Switchyard Lighting Fixture:			150,820.00	56,557.50
Schedule 2AB20 : Aluminum Tube, Connector and Miscellaneous Hardwar			171,696.28	64,386.11
Schedule 2AB21 : Bus Fitting	THB	227,247.93		85,217.97



นางสุตารัตน์ ไชยพันธุ์  
ผู้อำนวยการฝ่ายวิศวกรรมระบบส่ง

31 Aug 2022

นางสาวอัสยา ช่างวิทยากร

นางสาวอัสยา ช่างวิทยากร  
หจคส-ท.

21 ก.ย. 2565

**MEDIUM COST FOR BID NO. RTS2-S-09**  
**PART 2AB : SUPPLY AND INSTALLATION OF SUBSTATION EQUIPMENT**  
**SUPPLY AND CONSTRUCTION OF 115 KV BHUMIBOL SUBSTATION (GIS)**  
**TRANSMISSION SYSTEM EXPANSION AND RENOVATION PROJECT PHASE 2**

Description	Currency	Supply of Equipment		Local Transportation, Construction and Installation ( excluding VAT ) Baht
		Foreign Supply	Local Supply	
		CIF Thai Port	Ex-works Price ( excluding VAT ) Baht	
		Amount	Amount	
Schedule 2AB22 : Grounding Material	THB	281,287.13	289,446.64	214,025.16
Schedule 2AB23 : Substation Miscellaneous	THB	29,814.40	451,252.40	180,400.05
Schedule 2AB24 : Control and Protection System			49,400,361.00	4,940,031.58
Schedule 2AB25 : Fault Recording System			3,403,026.00	340,302.00



นางสุดารัตน์ ไชยพันธุ์  
 ผู้อำนวยการฝ่ายวิศวกรรมระบบส่ง

31 Aug 2022



นางสาวอัสยา ช่างวิทยากา  
 หจกส-ท.

21 ก.ย. 2565

**MEDIUM COST FOR BID NO. RTS2-S-09**  
**PART 2AB : SUPPLY AND INSTALLATION OF SUBSTATION EQUIPMENT**  
**SUPPLY AND CONSTRUCTION OF 115 KV BHUMIBOL SUBSTATION (GIS)**  
**TRANSMISSION SYSTEM EXPANSION AND RENOVATION PROJECT PHASE 2**

Description	Currency	Supply of Equipment		Local Transportation, Construction and Installation ( excluding VAT ) Baht
		Foreign Supply	Local Supply	
		CIF Thai Port	Ex-works Price ( excluding VAT ) Baht	
		Amount	Amount	
Schedule 2AB37 : Medium Voltage Switchgear	THB	12,340,901.00		232,856.00
Schedule 2AB39 : Commissioning				900,000.00
Schedule 2AB40 : Installation of Equipment and Steel Structure Supplied by EGA				40,000.00
<b>PART 2AB</b>	<b>THB</b>	<b>194,460,997.66</b>	<b>Baht</b>	<b>Baht</b>
			<b>82,813,954.92</b>	<b>49,453,898.60</b>



นางสุตารัตน์ ไชยพันธุ์  
 ผู้อำนวยการฝ่ายวิศวกรรมระบบส่ง

31 Aug 2022



นางสาวอัสยา ช่างวิทยากร  
 หจคส-ท.

21 ก.ย. 2565

**MEDIUM COST FOR BID NO. RTS2-S-09**  
**PART 2C : CIVIL WORK**  
**SUPPLY AND CONSTRUCTION OF 115 KV BHUMIBOL SUBSTATION (GIS)**  
**TRANSMISSION SYSTEM EXPANSION AND RENOVATION PROJECT PHASE 2**

Description	Local Currency ( excluding VAT ) Baht
	Amount
Schedule 2C1 : Foundation Work	3,137,484.00
Schedule 2C4 : Earth Work, Road and Crushed Rock Surfacing	50,220.00
Schedule 2C6 : Drainage System	932,976.00
Schedule 2C7 : Special Construction Works	139,517.72
<b>PART 2C</b>	<b>Baht</b> <b>4,260,197.72</b>



นางสุดารัตน์ ไชยพันธุ์  
 ผู้อำนวยการฝ่ายวิศวกรรมระบบส่ง

31 Aug 2022

*นางสาวอัสยา ช่างวิทยากา*

นางสาวอัสยา ช่างวิทยากา  
 หจตส-ท.

21 ก.ย. 2565

**MEDIUM COST FOR BID NO. RTS2-S-09**  
**PART 2D : SUPPLY OF SPARE PARTS**  
**SUPPLY AND CONSTRUCTION OF 115 KV BHUMIBOL SUBSTATION (GIS)**  
**TRANSMISSION SYSTEM EXPANSION AND RENOVATION PROJECT PHASE 2**

Description	Currency	Supply of Equipment		Local Transportation ( excluding VAT ) Baht Amount
		Foreign Supply	Local Supply	
		CIF Thai Port	Ex-works Price ( excluding VAT ) Baht	
		Amount	Amount	
Schedule 2D7 : Spare Parts for SF6 Gas Insulated Switchgear	THB	1,152,129.00		86,409.68
Schedule 2D11 : Spare Parts for Power Fuse, Fuse Link and Hook Sticks	THB	38,293.20		2,871.99
Schedule 2D37 : Spare Parts for Medium Voltage Switchgear	THB	398,569.00		29,892.68
<b>PART 2D</b>	<b>THB</b>	<b>1,588,991.20</b>	<b>Baht</b>	<b>Baht 119,174.35</b>

  
 นางสุตารัตน์ ไชยพันธ์  
 ผู้อำนวยการฝ่ายวิศวกรรมระบบส่ง  
 31 Aug 2022

  
 นางสาวอาสยา ช่างวิทยากร  
 ทจตส-ท.  
 21 ก.ย. 2565

**MEDIUM COST FOR BID NO. RTS2-S-09**  
**PART 2E : WORK ON SUPPLY EQUIPMENT BASIS**  
**SUPPLY AND CONSTRUCTION OF 115 KV BHUMIBOL SUBSTATION (GIS)**  
**TRANSMISSION SYSTEM EXPANSION AND RENOVATION PROJECT PHASE 2**

Description	Currency	Supply of Equipment		Local Transportation ( excluding VAT ) Baht Amount
		Foreign Supply	Local Supply	
		CIF Thai Port	Ex-works Price ( excluding VAT ) Baht	
		Amount	Amount	
Schedule 2E24 : Control and Protection System			2,724,579.00	136,227.00
<b>PART 2E</b>			<b>Baht</b> 2,724,579.00	<b>Baht</b> 136,227.00



นางสุตารัตน์ ไชยพันธุ์  
 ผู้อำนวยการฝ่ายวิศวกรรมระบบส่ง

31 Aug 2022

อรอน ชีวจันทน

นางสาวอรอน ชีวจันทน  
 พจตส-ท.

21 ก.ย. 2565



**MEDIUM COST FOR BID NO. RTS2-S-09**  
**SCHEDULE 3 : 230/115 KV BHUMIBOL SUBSTATION (GIS) (FIRE PROTECTION SYSTEM PHASE 3)**  
**SUPPLY AND CONSTRUCTION OF 230/115 KV BHUMIBOL SUBSTATION (GIS)**  
**FIRE PROTECTION SYSTEM PHASE 3**

Description	Currency	Supply of Equipment		Local Currency ( excluding VAT ) Baht	Local Transportation ( excluding VAT ) Baht	Local Transportation, Construction and Installation ( excluding VAT ) Baht
		Foreign Supply	Local Supply			
		CIF Thai Port	Ex-works Price ( excluding VAT ) Baht			
		Amount	Amount			
PART 3C : CIVIL WORK				44,025,486.80		
<b>TOTAL PRICE</b>			<b>Baht</b>	<b>Baht</b> 44,025,486.80	<b>Baht</b>	<b>Baht</b>

  
 นางสุตารัตน์ ไชยพันธุ์  
 ผู้อำนวยการฝ่ายวิศวกรรมระบบส่ง  
 31 Aug 2022

  
 นางสาวอัสยา ช่างวิทยากาน  
 หจกส-ท.  
 21 ก.ย. 2565

**MEDIUM COST FOR BID NO. RTS2-S-09**  
**PART 3C : CIVIL WORK**  
**SUPPLY AND CONSTRUCTION OF 230/115 KV BHUMIBOL SUBSTATION (GIS)**  
**FIRE PROTECTION SYSTEM PHASE 3**

Description	<b>Local Currency</b> ( excluding VAT ) Baht
	Amount
Schedule 3C7 : Special Construction Works	1,421,956.55
Schedule 3C9 : Fire Protection System	42,603,530.25
<b>PART 3C</b>	<b>Baht</b> <b>44,025,486.80</b>

  
 นางสาวสุดารัตน์ ไชยพันธุ์  
 ผู้อำนวยการฝ่ายวิศวกรรมระบบส่ง  
 31 Aug 2022

  
 นางสาวอาสยา ช่างวิทยากา  
 หจกส-ท.  
 21 ก.ย. 2565

อาสน์ ชัยวัฒน์  
 นางสาวอาสน์ ช่างวิทยากร  
 ทจตส-ท.  
 21 ก.ย. 2565

**MEDIUM COST FOR BID NO. RTS2-S-09**  
**SCHEDULE 4 : 230 KV BHUMIBOL DAM POWER PLANT SWITCHYARD**  
**SUPPLY AND CONSTRUCTION FOR IMPROVEMENT OF 230 KV BHUMIBOL DAM POWER PLANT SWITCHYARD**  
**TRANSMISSION SYSTEM EXPANSION AND RENOVATION PROJECT PHASE 2**

Description	Currency	Supply of Equipment		Local Currency (excluding VAT) Baht	Local Transportation (excluding VAT) Baht	Local Transportation, Construction and Installation (excluding VAT) Baht
		Foreign Supply	Local Supply			
		CIF Thai Port	Ex-works Price (excluding VAT) Baht			
		Amount	Amount			
PART 4AB : SUPPLY AND INSTALLATION OF SUBSTATION EQUIPMENT			6,462,158.00			1,657,696.14
PART 4D : SUPPLY OF SPARE PARTS			1,498,330.00		74,916.00	
<b>TOTAL PRICE</b>			<b>Baht 7,960,488.00</b>	<b>Baht</b>	<b>Baht 74,916.00</b>	<b>Baht 1,657,696.14</b>

  
 นางสุดารัตน์ ไชยพันธุ์  
 ผู้อำนวยการฝ่ายวิศวกรรมระบบส่ง  
 31 Aug 2022

**MEDIUM COST FOR BID NO. RTS2-S-09**  
**PART 4AB : SUPPLY AND INSTALLATION OF SUBSTATION EQUIPMENT**  
**SUPPLY AND CONSTRUCTION FOR IMPROVEMENT OF 230 KV BHUMIBOL DAM POWER PLANT SWITCHYARD**  
**TRANSMISSION SYSTEM EXPANSION AND RENOVATION PROJECT PHASE 2**

Description	Currency	Supply of Equipment		Local Transportation, Construction and Installation ( excluding VAT ) Baht Amount
		Foreign Supply	Local Supply	
		CIF Thai Port	Ex-works Price ( excluding VAT ) Baht	
		Amount	Amount	
Schedule 4AB18 : Low Voltage Cable and Conductor			1,649,780.00	412,445.00
Schedule 4AB24 : Control and Protection System			4,544,558.00	621,732.98
Schedule 4AB25 : Fault Recording System				36,814.16



นางสุดารัตน์ ไชยพันธุ์  
ผู้อำนวยการฝ่ายวิศวกรรมระบบส่ง

31 Aug 2022

นางสาวอัสยา ช่างวิทยากาน

นางสาวอัสยา ช่างวิทยากาน  
หจกส-ท.

21 ก.ย. 2565

**MEDIUM COST FOR BID NO. RTS2-S-09**  
**PART 4AB : SUPPLY AND INSTALLATION OF SUBSTATION EQUIPMENT**  
**SUPPLY AND CONSTRUCTION FOR IMPROVEMENT OF 230 KV BHUMIBOL DAM POWER PLANT SWITCHYARD**  
**TRANSMISSION SYSTEM EXPANSION AND RENOVATION PROJECT PHASE 2**

Description	Currency	Supply of Equipment		Local Transportation, Construction and Installation ( excluding VAT ) Baht
		Foreign Supply	Local Supply	
		CIF Thai Port	Ex-works Price ( excluding VAT ) Baht	
		Amount	Amount	
Schedule 4AB35 : Communication Cable			267,820.00	487,580.00
Schedule 4AB38 : Remote Terminal Unit				99,124.00
<b>PART 4AB</b>			<b>Baht</b> 6,462,158.00	<b>Baht</b> 1,657,696.14



นางสุดารัตน์ ไชยพันธุ์  
 ผู้อำนวยการฝ่ายวิศวกรรมระบบส่ง

31 Aug 2022

อวส. ออชผค.

นางสาวอวสยา ช่างวิทยากร  
 หจกส.ท.

21 ก.ย. 2565

**MEDIUM COST FOR BID NO. RTS2-S-09**  
**PART 4D : SUPPLY OF SPARE PARTS**  
**SUPPLY AND CONSTRUCTION FOR IMPROVEMENT OF 230 KV BHUMIBOL DAM POWER PLANT SWITCHYARD**  
**TRANSMISSION SYSTEM EXPANSION AND RENOVATION PROJECT PHASE 2**

Description	Currency	Supply of Equipment		Local Transportation ( excluding VAT ) Baht
		Foreign Supply	Local Supply	
		CIF Thai Port	Ex-works Price ( excluding VAT ) Baht	( excluding VAT ) Baht
		Amount	Amount	Amount
Schedule 4D24 : Spare Parts for Control and Protection System			1,498,330.00	74,916.00
<b>PART 4D</b>			<b>Baht</b> 1,498,330.00	<b>Baht</b> 74,916.00



นางสุตารัตน์ ไชยพันธุ์  
 ผู้อำนวยการฝ่ายวิศวกรรมระบบส่ง

31 Aug 2022



นางสาวอัสยา ช่างวิทยากษ  
 ทจตส-ท.

21 ก.ย. 2565

อรุณ ชื่นชื่น  
นางสาวอาสยา ช่างวิทยากษ  
หงตส-ท.  
21 ก.ย. 2565

**MEDIUM COST FOR BID NO. RTS2-S-09**  
**SCHEDULE 5 : 230 KV TAK 2 SUBSTATION**  
**SUPPLY AND CONSTRUCTION FOR IMPROVEMENT OF 230 KV TAK 2 SUBSTATION**  
**TRANSMISSION SYSTEM EXPANSION AND RENOVATION PROJECT PHASE 2**

Description	Currency	Supply of Equipment		Local Currency (excluding VAT) Baht Amount	Local Transportation (excluding VAT) Baht Amount	Local Transportation, Construction and Installation (excluding VAT) Baht Amount
		Foreign Supply	Local Supply			
		CIF Thai Port	Ex-works Price (excluding VAT) Baht			
		Amount	Amount			
PART 5AB : SUPPLY AND INSTALLATION OF SUBSTATION EQUIPMENT			1,678,869.00			357,670.01
PART 5D : SUPPLY OF SPARE PARTS			749,165.00		37,458.00	
<b>TOTAL PRICE</b>			<b>Baht 2,428,034.00</b>	<b>Baht</b>	<b>Baht 37,458.00</b>	<b>Baht 357,670.01</b>



นางสุดารัตน์ ไชยพันธุ์  
ผู้อำนวยการฝ่ายวิศวกรรมระบบส่ง

31 Aug 2022

**MEDIUM COST FOR BID NO. RTS2-S-09**  
**PART 5AB : SUPPLY AND INSTALLATION OF SUBSTATION EQUIPMENT**  
**SUPPLY AND CONSTRUCTION FOR IMPROVEMENT OF 230 KV TAK 2 SUBSTATION**  
**TRANSMISSION SYSTEM EXPANSION AND RENOVATION PROJECT PHASE 2**

Description	Currency	Supply of Equipment		Local Transportation, Construction and Installation ( excluding VAT ) Baht Amount
		Foreign Supply	Local Supply	
		CIF Thai Port	Ex-works Price ( excluding VAT ) Baht	
		Amount	Amount	
Schedule 5AB18 : Low Voltage Cable and Conductor			662,970.00	165,742.50
Schedule 5AB24 : Control and Protection System			1,015,899.00	154,601.90
Schedule 5AB25 : Fault Recording System				14,726.00

  
 นางสาวสุตารัตน์ ไชยพันธุ์  
 ผู้อำนวยการฝ่ายวิศวกรรมระบบส่ง  
 31 Aug 2022

  
 นางสาวอสาสา ช่างวิทยากา  
 พจตส-ท.  
 21 ก.ย. 2565



**MEDIUM COST FOR BID NO. RTS2-S-09**  
**PART 5AB : SUPPLY AND INSTALLATION OF SUBSTATION EQUIPMENT**  
**SUPPLY AND CONSTRUCTION FOR IMPROVEMENT OF 230 KV TAK 2 SUBSTATION**  
**TRANSMISSION SYSTEM EXPANSION AND RENOVATION PROJECT PHASE 2**

Description	Currency	Supply of Equipment		Local Transportation, Construction and Installation ( excluding VAT ) Baht Amount
		Foreign Supply	Local Supply	
		CIF Thai Port	Ex-works Price ( excluding VAT ) Baht	
		Amount	Amount	
Schedule 5AB38 : Remote Terminal Unit				22,599.61
<b>PART 5AB</b>			<b>Baht 1,678,869.00</b>	<b>Baht 357,670.01</b>



นางสุตารัตน์ ไชยพันธุ์  
ผู้อำนวยการฝ่ายวิศวกรรมระบบส่ง

31 Aug 2022



นางสาวอัสยา ช่างวิทยากร  
หงตส-ท.

21 ก.ย. 2565

**MEDIUM COST FOR BID NO. RTS2-S-09**  
**PART 5D : SUPPLY OF SPARE PARTS**  
**SUPPLY AND CONSTRUCTION FOR IMPROVEMENT OF 230 KV TAK 2 SUBSTATION**  
**TRANSMISSION SYSTEM EXPANSION AND RENOVATION PROJECT PHASE 2**

Description	Currency	Supply of Equipment		Local Transportation ( excluding VAT ) Baht
		Foreign Supply	Local Supply	
		CIF Thai Port	Ex-works Price ( excluding VAT ) Baht	( excluding VAT ) Baht
		Amount	Amount	Amount
Schedule 5D24 : Spare Parts for Control and Protection System			749,165.00	37,458.00
<b>PART 5D</b>			<b>Baht 749,165.00</b>	<b>Baht 37,458.00</b>



นางสุตารัตน์ ไชยพันธุ์  
 ผู้อำนวยการฝ่ายวิศวกรรมระบบส่ง

31 Aug 2022



นางสาวอาสยา ช่างวิทยากา  
 หจกส-ท.

21 ก.ย. 2565



นางสาวอัสยา ช่างวิทยากร  
 วิศวกร  
 21 ก.ย. 2565

**MEDIUM COST FOR BID NO. RTS2-S-09**  
**1AB2 : Distribution Transformer**  
**SUPPLY AND CONSTRUCTION OF 230 KV BHUMIBOL SUBSTATION (GIS)**  
**TRANSMISSION SYSTEM EXPANSION AND RENOVATION PROJECT PHASE 2**

Item No.	Description	Qty.	Unit	Currency	Supply of Equipment				Local Transportation, Construction and (excluding VAT) Baht			
					Foreign Supply		Local Supply		Unit Price	Amount	Unit Price	Amount
					CIF Thai Port		Ex-works Price (excluding VAT) Baht					
					Unit Price	Amount	Unit Price	Amount	Unit Price	Amount		
1AB2-1	500 kVA, 22000-400/230V distribution transformer, oil immersed, outdoor type as per Ratings and Features RF DX2702	2		THB			899,000.00	1,798,000.00	XXXXX	XXXXX		
1AB2-2	Cost of Local Transportation, Construction and Installation for Item No. 1AB2-1	Lump sum	Lump sum		XXXXXX	XXXXXX	XXXXXX	XXXXXX	269,700.00	269,700.00		
				<b>THB</b>			<b>Baht</b>		<b>Baht</b>			
							<b>1,798,000.00</b>		<b>269,700.00</b>			
<b>Total Price for Schedule 1AB2</b>												

นางสุดารัตน์ ไชยพันธุ์  
 ผู้อำนวยการฝ่ายวิศวกรรมระบบส่ง

31 Aug 2022

**MEDIUM COST FOR BID NO. RTS2-S-09**  
**1AB6 : Coupling Capacitor Voltage Transformer, Coupling Capacitor, Voltage Transformer and Junction Box**  
**SUPPLY AND CONSTRUCTION OF 230 KV BHUMIBOL SUBSTATION (GIS)**  
**TRANSMISSION SYSTEM EXPANSION AND RENOVATION PROJECT PHASE 2**

Item No.	Description	Qty.	Unit	Currency	Supply of Equipment				Local Transportation, Construction and Installation (excluding VAT) Baht			
					Foreign Supply		Local Supply		Unit Price	Amount	Unit Price	Amount
					CIF Thai Port		Ex-works Price (excluding VAT) Baht					
					Unit Price	Amount	Unit Price	Amount	Unit Price	Amount		
1AB6-1	22 kV VT, 150 kV BIL, 22000/√3-110/√3&110/√3 V oil filled as per Ratings and Features RF VT 2012	6		THB			103,000.00	618,000.00	XXXXXX	XXXXXX		
1AB6-2	Junction Box type PT6 ( for Item No. 1AB6-1 ) as per Dwg. No. TP-E-18.1-2/4, 3/4 and TP-E-18.4	2		THB			41,000.00	82,000.00	XXXXXX	XXXXXX		
1AB6-3	Cost of Local Transportation, Construction and Installation for Item No. 1AB6-1 thru 1AB6-2	Lump sum	Lump sum		XXXXXX	XXXXXX	XXXXXX	XXXXXX	105,000.00	105,000.00		
				<b>THB</b>			<b>Baht</b>		<b>Baht</b>			
							<b>700,000.00</b>		<b>105,000.00</b>			
				<b>Total Price for Schedule 1AB6</b>								

นางสุดารัตน์ ไชยพันธุ์  
 ผู้อำนวยการฝ่ายวิศวกรรมระบบส่ง

31 Aug 2022

นางสาวอาสยา ช่างวิทยากร  
 21 ก.ย. 2565

**MEDIUM COST FOR BID NO. RTS2-S-09**  
**1AB7 : SF6 Gas Insulated Switchgear**  
**SUPPLY AND CONSTRUCTION OF 230 KV BHUMIBOL SUBSTATION (GIS)**  
**TRANSMISSION SYSTEM EXPANSION AND RENOVATION PROJECT PHASE 2**

Item No.	Description	Qty.	Unit	Currency	Supply of Equipment				Local Transportation, Construction and Installation (excluding VAT) Baht			
					Foreign Supply		Local Supply		Ex-works Price (excluding VAT) Baht			
					CIF Thai Port							
					Unit Price	Amount	Unit Price	Amount	Unit Price	Amount		
1AB7-1	245 kV 4000 A 50 kA Gas Insulated Switchgear as per Ratings and Features RF IS8450(IEC) and Drawing No. BB-S-1-01/04 and BB-S-1-02/04 and BB-S-2-01/01 (Line No.1 to Bhumibol Hydro Power Plant & KT1A)	1		THB	90,983,172.00	90,983,172.00			XXXXX	XXXXX		
1AB7-2	245 kV 4000 A 50 kA Gas Insulated Switchgear as per Ratings and Features RF IS8450(IEC) and Drawing No. BB-S-1-01/04 and BB-S-1-02/04 and BB-S-2-01/01 (Line No.2 to Bhumibol Hydro Power Plant & KT2A)	1		THB	90,983,172.00	90,983,172.00			XXXXX	XXXXX		
1AB7-3	245 kV 4000 A 50 kA Gas Insulated Switchgear as per Ratings and Features RF IS8450(IEC) and Drawing No. BB-S-1-01/04 and BB-S-1-02/04 and BB-S-2-01/01 (Line No.1 to Bhumibol Floating Solar (Future) & Line No.1 to Tak 2)	1		THB	90,983,172.00	90,983,172.00			XXXXX	XXXXX		



นางสุตารัตน์ ไชยพันธุ์  
 ผู้อำนวยการฝ่ายวิศวกรรมระบบส่ง

31 Aug 2022

  
 นางสาวอาสยา ช่างวิทยากา  
 วิศวกร-ท.  
 21 ก.ย. 2565

**MEDIUM COST FOR BID NO. RTS2-S-09**  
**1AB7 : SF6 Gas Insulated Switchgear**  
**SUPPLY AND CONSTRUCTION OF 230 KV BHUMIBOL SUBSTATION (GIS)**  
**TRANSMISSION SYSTEM EXPANSION AND RENOVATION PROJECT PHASE 2**

Item No.	Description	Qty.	Unit	Currency	Supply of Equipment				Local Transportation, Construction and Installation (excluding VAT) Baht			
					Foreign Supply		Local Supply		Ex-works Price (excluding VAT) Baht			
					CIF Thai Port							
					Unit Price	Amount	Unit Price	Amount	Unit Price	Amount		
1AB7-4	245 kV 4000 A 50 kA Gas Insulated Switchgear as per Ratings and Features RF IS8450(IEC) and Drawing No. BB-S-1-01/04 and BB-S-1-02/04 and BB-S-2-01/01 (Line No.2 to Bhumibol Floating Solar (Future) & Line No.2 to Tak 2(Future))	1		THB	90,983,172.00	90,983,172.00			XXXXX	XXXXX		
1AB7-5	245 kV 4000 A 50 kA Gas Insulated Switchgear as per Ratings and Features RF IS8450(IEC) and Drawing No. BB-S-1-01/04 and BB-S-1-02/04 and BB-S-2-01/01 Indoor type (Main bus No.1 & 2, Voltage Transformer and High Speed Grounding Switch at Main Bus)	lot		THB	included	included			XXXXX	XXXXX		
1AB7-6	245 kV 4000 A 50 kA Gas Insulated Switchgear as per Ratings and Features RF IS8450(IEC) outdoor type (GIB) as per Drawing No. BB-S-1-01/04 and BB-S-1-02/04 and BB-S-2-01/01	lot		THB	included	included			XXXXX	XXXXX		
1AB7-7	Local control cubicle for IS8450 for item 1AB7-1 thru 1AB7-6*	12	set	THB	included	included			XXXXX	XXXXX		
1AB7-8	Steel Supporting Structure for IS8450*	lot		THB	included	included			XXXXX	XXXXX		

  
 นางสุดารัตน์ ไชยพันธุ์  
 ผู้อำนวยการฝ่ายวิศวกรรมระบบส่ง

31 Aug 2022

- Project 1-1C2 -

filename : RTS2-S-09-1 (230 kV BB)

**MEDIUM COST FOR BID NO. RTS2-S-09**  
**1AB7 : SF6 Gas Insulated Switchgear**  
**SUPPLY AND CONSTRUCTION OF 230 KV BHUMIBOL SUBSTATION (GIS)**  
**TRANSMISSION SYSTEM EXPANSION AND RENOVATION PROJECT PHASE 2**

อนันต์ ชัยวัฒน์  
นางสาวอภิสรา ช่างวิทยากุล  
พจตส.พ.  
21 ก.ย. 2565

Item No.	Description	Qty.	Unit	Currency	Supply of Equipment				Local Transportation, Construction and Installation			
					Foreign Supply		Local Supply		Ex-works Price (excluding VAT) Baht		(excluding VAT) Baht	
					CIF Thai Port							
					Unit Price	Amount	Unit Price	Amount	Unit Price	Amount		
1AB7-9	Removable service platform and removable ladder for GIS inspection	lot		THB	included	included			XXXXX	XXXXX		
1AB7-10	Cost of Local Transportation, Construction and Installation for Item No. 1AB7-1 thru 1AB7-9	Lump sum	Lump sum		XXXXXX	XXXXXX	XXXXXX	XXXXXX	54,589,903.20	54,589,903.20		
	Note : The SF6 gas in a quantity equivalent to 115% of the total equipment actual requirement shall be provided as follows: - 100% of SF6 gas quantity shall be shipped in returnable steel bottles which shall be returned back to Contractor. - 15% of SF6 gas quantity shall be shipped in non-returnable steel bottles which shall become the property of EGAT.											
<b>Total Price for Schedule 1AB7</b>				THB	<b>363,932,688.00</b>		Baht		<b>Baht 54,589,903.20</b>			

\* The design of supporting structures and LCC for Gas Insulated Switchgear shall be verified by Gas Insulated Switchgear manufacturer.

นางสุดารัตน์ ไชยพันธุ์  
ผู้อำนวยการฝ่ายวิศวกรรมระบบส่ง  
31 Aug 2022



  
 นางสาวอาริษา ช่างวิทยากา  
 วิศวกร-ท.  
 21 ก.ย. 2565

**MEDIUM COST FOR BID NO. RTS2-S-09**  
**1AB11 : Power Fuse, Fuse Link and Hook Stick**  
**SUPPLY AND CONSTRUCTION OF 230 KV BHUMIBOL SUBSTATION (GIS)**  
**TRANSMISSION SYSTEM EXPANSION AND RENOVATION PROJECT PHASE 2**

Item No.	Description	Qty.	Unit	Currency	Supply of Equipment				Local Transportation, Construction and Installation (excluding VAT) Baht			
					Foreign Supply		Local Supply		Ex-works Price (excluding VAT) Baht			
					CIF Thai Port							
					Unit Price	Amount	Unit Price	Amount	Unit Price	Amount		
1AB11-1	22 kV 100 A 12.5 kA 1-pole dropout fuse as per Ratings and Features RF PF2111 (Not including fuse link or refill unit)	6		THB	159,044.60	954,267.60			XXXXX	XXXXX		
1AB11-2	Fuse link or refill unit 20E for 22 kV power fuse (standard speed)	6		THB	12,764.40	76,586.40			XXXXX	XXXXX		
1AB11-3	6.10 m. (20 ft.) hook stick combination operating hook stick and fuse remover, (14 ft universal with male pin and 6 ft pole extension with female pin) for use with the above power fuse	1		THB	30,156.50	30,156.50			XXXXX	XXXXX		
1AB11-4	Cost of Local Transportation, Construction and Installation for Item No. 1AB11-1 thru 1AB11-3	Lump sum	Lump sum		XXXXX	XXXXX	XXXXX	XXXXX	159,151.58	159,151.58		
				<b>THB</b>	<b>1,061,010.50</b>		<b>Baht</b>		<b>Baht</b>			
<b>Total Price for Schedule 1AB11</b>									<b>159,151.58</b>			

  
 นางสุตารัตน์ ไชยพันธุ์  
 ผู้อำนวยการฝ่ายวิศวกรรมระบบส่ง  
 31 Aug 2022

  
 นางสาวอาสยา ช่างวิทยากุล  
 ทจตส-ท.  
 21 ก.ย. 2565

**MEDIUM COST FOR BID NO. RTS2-S-09**  
**1AB12 : AC&DC Distribution Board and Termination Box**  
**SUPPLY AND CONSTRUCTION OF 230 KV BHUMIBOL SUBSTATION (GIS)**  
**TRANSMISSION SYSTEM EXPANSION AND RENOVATION PROJECT PHASE 2**

Item No.	Description	Qty.	Unit	Currency	Supply of Equipment				Local Transportation, Construction and Installation (excluding VAT) Baht			
					Foreign Supply		Local Supply		Unit Price	Amount	Unit Price	Amount
					CIF Thai Port		Ex-works Price (excluding VAT) Baht					
					Unit Price	Amount	Unit Price	Amount	Unit Price	Amount		
1AB12-1	400/230 Vac Load Center Unit Substation (LCUS) as per Dwg. No. TP-418 and as per Ratings and Features RF LVCB	1					1,236,250.00	1,236,250.00	XXXXX	XXXXX		
1AB12-2	Lighting Relay Panel (LRP) as per Dwg. No. LT-RP-0-03	1					137,137.00	137,137.00	XXXXX	XXXXX		
1AB12-3	Safety switch 600 Vac 800 A, 4 wire, solid neutral (S/N), 3 blades, 3 fuses time lag type, outdoor NEMA 4X enclosure or higher, completed with 800 A fuses.	2					258,301.00	516,602.00	XXXXX	XXXXX		
1AB12-4	Termination Box type TB1 as per Dwg No. LT-TB-0-01	2					4,265.00	8,530.00	XXXXX	XXXXX		
1AB12-5	Outdoor Receptacle Box type ORB1 as per Dwg. No. SE-ORB-0-01	1					18,664.00	18,664.00	XXXXX	XXXXX		
1AB12-6	Outdoor Receptacle Box type ORB3 as per Dwg. No. SE-ORB-0-01	1					38,198.00	38,198.00	XXXXX	XXXXX		
1AB12-7	22kV 100A 12.5kA Load break switch with Cable Termination as per Ratings and Features RF LB2110	2					763,298.00	1,526,596.00	XXXXX	XXXXX		
1AB12-8	400/230 Vac Distribution Board as per Dwg. No. TP-E-4.2	2					220,187.00	440,374.00	XXXXX	XXXXX		

  
 นางสุตารัตน์ ไชยพันธุ์  
 ผู้อำนวยการฝ่ายวิศวกรรมระบบส่ง

**MEDIUM COST FOR BID NO. RTS2-S-09**  
**1AB12 : AC&DC Distribution Board and Termination Box**  
**SUPPLY AND CONSTRUCTION OF 230 KV BHUMIBOL SUBSTATION (GIS)**  
**TRANSMISSION SYSTEM EXPANSION AND RENOVATION PROJECT PHASE 2**

Item No.	Description	Qty.	Unit	Currency	Supply of Equipment				Local Transportation, Construction and Installation (excluding VAT) Baht			
					Foreign Supply		Local Supply		Unit Price	Amount	Unit Price	Amount
					CIF Thai Port		Ex-works Price (excluding VAT) Baht					
					Unit Price	Amount	Unit Price	Amount	Unit Price	Amount		
1AB12-9	125 Vdc Power Panel as per Dwg. No. TP-E-4.4	2						233,188.00	466,376.00	XXXXX	XXXXX	
1AB12-10	125 Vdc Distribution Board as per Dwg. No. TP-E-4.4	4						142,168.00	568,672.00	XXXXX	XXXXX	
1AB12-11	Cost of Local Transportation, Construction and Installation for Item No. 1AB12-1 thru 1AB12-10	Lump sum	Lump sum		XXXXXX	XXXXXX	XXXXXX	XXXXXX	XXXXXX	743,609.85	743,609.85	
<b>Total Price for Schedule 1AB12</b>								<b>Baht 4,957,399.00</b>		<b>Baht 743,609.85</b>		



นางสุตารัตน์ ไชยพันธุ์  
 ผู้อำนวยการฝ่ายวิศวกรรมระบบส่ง

31 Aug 2022



นางสาวอัสยา ช่างวิทยากร  
 หจกส-ท.

21 ก.ย. 2565

อนุช ชื่นชื่น  
 นางสาวอนุช ชื่นชื่น  
 21 ก.ย. 2565

**MEDIUM COST FOR BID NO. RTS2-S-09**  
**1AB13 : Stationary Battery and Battery Charger**  
**SUPPLY AND CONSTRUCTION OF 230 KV BHUMIBOL SUBSTATION (GIS)**  
**TRANSMISSION SYSTEM EXPANSION AND RENOVATION PROJECT PHASE 2**

Item No.	Description	Qty.	Unit	Currency	Supply of Equipment				Local Transportation, Construction and Installation			
					Foreign Supply		Local Supply		Ex-works Price (excluding VAT) Baht		(excluding VAT) Baht	
					CIF Thai Port							
					Unit Price	Amount	Unit Price	Amount	Unit Price	Amount		
1AB13-1	Vented stationary battery, 58 cells (tubular type) for 125 Vdc system complete with electrolyte and battery rack as per Specification attached (Designed by Contractor)											
1AB13-1a	a) Battery	2	set	THB	1,398,100.00	2,796,200.00			XXXXX	XXXXX		
1AB13-1b	b) Electrolyte	2	set	THB	22,822.00	45,644.00			XXXXX	XXXXX		
1AB13-1c	c) Battery Rack	2	set	THB	85,582.00	171,164.00			XXXXX	XXXXX		
1AB13-2	125 Vdc battery charger having sufficient rated DC output current, but not less than 15 % of associated battery 8 hour drainage rate, complete with all accessories as per Specification attached , and shall be suitable for use with substation battery Item No. 1AB13-1	3					674,300.00	2,022,900.00	XXXXX	XXXXX		
1AB13-3	Cost of Local Transportation, Construction and Installation for Item No. 1AB13-1 thru 1AB13-2	Lump sum	Lump sum		XXXXX	XXXXX	XXXXX	XXXXX	755,386.20	755,386.20		
<b>Total Price for Schedule 1AB13</b>				<b>THB</b>	<b>3,013,008.00</b>		<b>Baht</b>		<b>Baht</b>			
							<b>2,022,900.00</b>		<b>755,386.20</b>			

  
 นางสุตารัตน์ ไชยพันธุ์  
 ผู้อำนวยการฝ่ายวิศวกรรมระบบส่ง

31 Aug 2022

  
 นางสาวอาสยา ช่างวิทยากร  
 วิศวกร-ท.  
 21 ก.ย. 2565

**MEDIUM COST FOR BID NO. RTS2-S-09**  
**1AB14 : Substation Steel Structure**  
**SUPPLY AND CONSTRUCTION OF 230 KV BHUMIBOL SUBSTATION (GIS)**  
**TRANSMISSION SYSTEM EXPANSION AND RENOVATION PROJECT PHASE 2**

Item No.	Description	Qty.	Unit	Currency	Supply of Equipment				Local Transportation, Construction and Installation			
					Foreign Supply		Local Supply		Ex-works Price (excluding VAT) Baht		(excluding VAT) Baht	
					CIF Thai Port							
					Unit Price	Amount	Unit Price	Amount	Unit Price	Amount		
1AB14-1	230 kV take-off structure (TS803) Design by Contractor see Dwg. No. BB-S-7-02/02 for reference	3					1,469,426.00	4,408,278.00	XXXXX	XXXXX		
1AB14-2	230 kV beam (BB807) Design by Contractor see Dwg. No. BB-S-7-02/02 for reference	2					363,990.00	727,980.00	XXXXX	XXXXX		
1AB14-3	Junction box support structure (JB001) as per Dwg. No. ST-JB-0-01	2					9,479.00	18,958.00	XXXXX	XXXXX		
1AB14-4	Junction box support structure (JB003) as per Dwg. No. ST-JB-0-03	2					7,325.00	14,650.00	XXXXX	XXXXX		
1AB14-5	Telecommunication Tower Type WSA (H = 30.00 m) as per Dwg. No. UWC-06-WSA-501, 502, 503, 504	1					448,093.00	448,093.00	XXXXX	XXXXX		
1AB14-6	Cost of Local Transportation, Construction and Installation for Item No. 1AB14-1 thru 1AB14-5	Lump sum	Lump sum			XXXXX	XXXXX	XXXXX	XXXXX	2,106,734.63	2,106,734.63	
<b>Total Price for Schedule 1AB14</b>							<b>Baht</b> <b>5,617,959.00</b>		<b>Baht</b> <b>2,106,734.63</b>			

  
 นางสุดารัตน์ ไชยพันธุ์  
 ผู้อำนวยการฝ่ายวิศวกรรมระบบส่ง  
 31 Aug 2022

**MEDIUM COST FOR BID NO. RTS2-S-09**

**1AB15 : Insulator**

**SUPPLY AND CONSTRUCTION OF 230 KV BHUMIBOL SUBSTATION (GIS)  
TRANSMISSION SYSTEM EXPANSION AND RENOVATION PROJECT PHASE 2**

Item No.	Description	Qty.	Unit	Currency	Supply of Equipment				Local Transportation, Construction and Installation (excluding VAT) Baht			
					Foreign Supply		Local Supply		Ex-works Price (excluding VAT) Baht			
					CIF Thai Port							
					Unit Price	Amount	Unit Price	Amount	Unit Price	Amount		
1AB15-1	Suspension insulator ANSI 52-3 as per Specification attached	Lump sum	Lump sum		supplied by EGAT	supplied by EGAT	supplied by EGAT	supplied by EGAT	XXXXX	XXXXX		
1AB15-2	230 kV station post insulator ANSI TR. No. 308	Lump sum	Lump sum		supplied by EGAT	supplied by EGAT	supplied by EGAT	supplied by EGAT	XXXXX	XXXXX		
1AB15-3	Cost of Local Transportation, Construction and Installation for Item No. 1AB15-1 thru 1AB15-2	Lump sum	Lump sum		XXXXXX	XXXXXX	XXXXXX	XXXXXX	70,656.30	70,656.30		
<b>Total Price for Schedule 1AB15</b>							<b>Baht</b>		<b>Baht 70,656.30</b>			

  
 นางสุตารัตน์ ไชยพันธุ์  
 ผู้อำนวยการฝ่ายวิศวกรรมระบบส่ง  
 31 Aug 2022

  
 นางสาวอาสยา ช่างวิทยากา  
 หจกตส-ท.  
 21 ก.ย. 2565

**MEDIUM COST FOR BID NO. RTS2-S-09**  
**1AB16 : Cable Terminations**  
**SUPPLY AND CONSTRUCTION OF 230 KV BHUMIBOL SUBSTATION (GIS)**  
**TRANSMISSION SYSTEM EXPANSION AND RENOVATION PROJECT PHASE 2**

Item No.	Description	Qty.	Unit	Currency	Supply of Equipment				Local Transportation, Construction and Installation ( excluding VAT ) Baht			
					Foreign Supply		Local Supply					
					CIF Thai Port		Ex-works Price ( excluding VAT ) Baht		Unit Price	Amount	Unit Price	Amount
					Unit Price	Amount	Unit Price	Amount				
1AB16-1	22 kV cable terminations for 1/C no. 35 sq.mm. XLPE power cable as per Ratings and Features RF TN212H	24		THB	5,453.80	130,891.20			XXXXX	XXXXX		
1AB16-2	Cable Cleats with necessary miscellaneous hardware for item no. 1AB17-1, trefoil formation 3-phase set (Design by Contractor) as per TNAC1	Lump sum	Lump sum	THB	58,190.00	58,190.00			XXXXX	XXXXX		
1AB16-3	Cable Cleats with necessary miscellaneous hardware for item no. 1AB17-1, flat formation 1-phase set (Design by Contractor) as per TNAC1	Lump sum	Lump sum	THB	39,600.00	39,600.00			XXXXX	XXXXX		
1AB16-4	Cost of Local Transportation, Construction and Installation for Item No. 1AB16-1 and 1AB16-3	Lump sum	Lump sum		XXXXXX	XXXXXX	XXXXXX	XXXXXX	85,755.45	85,755.45		
<b>Total Price for Schedule 1AB16</b>				THB	<b>228,681.20</b>		Baht		<b>Baht 85,755.45</b>			

  
นางสุตารัตน์ ไชยพันธุ์  
ผู้อำนวยการฝ่ายวิศวกรรมระบบส่ง  
31 Aug 2022

  
นางสาวอัสยา ช่างวิทยากร  
ทจตส-ท.  
21 ก.ย. 2565

**MEDIUM COST FOR BID NO. RTS2-S-09**  
**1AB17 : XLPE Power Cable**  
**SUPPLY AND CONSTRUCTION OF 230 KV BHUMIBOL SUBSTATION (GIS)**  
**TRANSMISSION SYSTEM EXPANSION AND RENOVATION PROJECT PHASE 2**

Item No.	Description	Qty.	Unit	Currency	Supply of Equipment				Local Transportation, Construction and Installation (excluding VAT) Baht			
					Foreign Supply		Local Supply					
					CIF Thai Port		Ex-works Price (excluding VAT) Baht		Unit Price	Amount	Unit Price	Amount
					Unit Price	Amount	Unit Price	Amount				
1AB17-1	22 kV 1/C no. 35 sq.mm. XLPE power cable as per Ratings and Features RF PC2110	Lump sum	Lump sum				119,900.00	119,900.00	XXXXXX	XXXXXX		
1AB17-2	Cost of Local Transportation, Construction and Installation for Item No. 1AB17-1	Lump sum	Lump sum		XXXXXX	XXXXXX	XXXXXX	XXXXXX	44,962.50	44,962.50		
<b>Total Price for Schedule 1AB17</b>							<b>Baht 119,900.00</b>		<b>Baht 44,962.50</b>			

  
 นางสุตารัตน์ ไชยพันธ์  
 ผู้อำนวยการฝ่ายวิศวกรรมระบบส่ง

31 Aug 2022

  
 นางสาวอาสยา ช่างวิทยากา  
 หมดส.ท.  
 21 ก.ย. 2565



**MEDIUM COST FOR BID NO. RTS2-S-09**  
**1AB18 : Low Voltage Cable and Conductor**  
**SUPPLY AND CONSTRUCTION OF 230 KV BHUMIBOL SUBSTATION (GIS)**  
**TRANSMISSION SYSTEM EXPANSION AND RENOVATION PROJECT PHASE 2**

Item No.	Description	Qty.	Unit	Currency	Supply of Equipment				Local Transportation, Construction and Installation (excluding VAT) Baht			
					Foreign Supply		Local Supply					
					CIF Thai Port		Ex-works Price (excluding VAT) Baht		Unit Price	Amount	Unit Price	Amount
					Unit Price	Amount	Unit Price	Amount				
1AB18-1	750 V power cable as per Specification attached	Lump sum	Lump sum				4,158,000.00	4,158,000.00	XXXXXX	XXXXXX		
1AB18-2	600 V control cable with PVC insulation as per Specification attached	Lump sum	Lump sum				583,110.00	583,110.00	XXXXXX	XXXXXX		
1AB18-3	750 V lighting cable (THW) as per Specification attached	Lump sum	Lump sum				8,250.00	8,250.00	XXXXXX	XXXXXX		
1AB18-4	750 V lighting cable (NYY) as per Specification attached	Lump sum	Lump sum				731,500.00	731,500.00	XXXXXX	XXXXXX		
1AB18-5	Annealed copper ground wire as per Specification attached	Lump sum	Lump sum				3,642,953.60	3,642,953.60	XXXXXX	XXXXXX		
1AB18-6	Overhead ground wire as per Specification attached	Lump sum	Lump sum				5,148.00	5,148.00	XXXXXX	XXXXXX		
1AB18-7	Aluminum conductor as per Specification attached	Lump sum	Lump sum				92,185.50	92,185.50	XXXXXX	XXXXXX		
1AB18-8	Cost of Local Transportation, Construction and Installation for Item No. 1AB18-1 thru 1AB18-7	Lump sum	Lump sum			XXXXXX	XXXXXX	XXXXXX	XXXXXX	3,457,930.16	3,457,930.16	
<b>Total Price for Schedule 1AB18</b>							<b>Baht 9,221,147.10</b>		<b>Baht 3,457,930.16</b>			

  
 นางสุตารัตน์ ไชยพันธุ์  
 ผู้อำนวยการฝ่ายวิศวกรรมระบบส่ง  
 31 Aug 2022

  
 นางสาวอาสยา ช่างวิทยากา  
 ทจคส-ท.  
 21 ก.ย. 2565

อรุณ ชินฉันทน  
นางสาวอาสยา ชาญวิทยากา  
พจตต-ท.  
21 ก.ย. 2565

**MEDIUM COST FOR BID NO. RTS2-S-09**  
**1AB19 : Switchyard Lighting Fixtures**  
**SUPPLY AND CONSTRUCTION OF 230 KV BHUMIBOL SUBSTATION (GIS)**  
**TRANSMISSION SYSTEM EXPANSION AND RENOVATION PROJECT PHASE 2**

Item No.	Description	Qty.	Unit	Currency	Supply of Equipment				Local Transportation, Construction and Installation (excluding VAT) Baht			
					Foreign Supply		Local Supply		Ex-works Price (excluding VAT) Baht			
					CIF Thai Port							
					Unit Price	Amount	Unit Price	Amount	Unit Price	Amount		
1AB19-1	Flood lighting fixture, LED lamp, 10000 lumen, wide-beam, complete with control gear as per Specification attached	4					15,082.00	60,328.00	XXXXX	XXXXX		
1AB19-2	Street lighting fixture, LED lamp, 5000 lumen, wide beam, complete with control gear as per Specification attached	26					14,686.00	381,836.00	XXXXX	XXXXX		
1AB19-3	Round galvanized steel lamp post H=2500 mm. (Design by Contractor) complete with 5 A 250 V plug fuse, 20 A 500 V terminal block for accepting 4 sq.mm. of incoming and outgoing cables and anchor bolts reference Dwg. No. ST-LP-0-03, SD-AB-0-01 and BB-L-1 (Installed on the top of concrete fence)	26					8,675.00	225,550.00	XXXXX	XXXXX		
1AB19-4	Cost of Local Transportation, Construction and Installation for Item No. 1AB19-1 thru 1AB19-3	Lump sum	Lump sum		XXXXX	XXXXX	XXXXX	XXXXX	250,392.75	250,392.75		
<b>Total Price for Schedule 1AB19</b>							<b>Baht</b>		<b>Baht</b>			
									<b>667,714.00</b>		<b>250,392.75</b>	

  
นางสุดารัตน์ ไชยพันธุ์  
ผู้อำนวยการฝ่ายวิศวกรรมระบบส่ง

31 Aug 2022

**MEDIUM COST FOR BID NO. RTS2-S-09**  
**1AB20 : Aluminum Tube, Connector and Miscellaneous Hardware**  
**SUPPLY AND CONSTRUCTION OF 230 KV BHUMIBOL SUBSTATION (GIS)**  
**TRANSMISSION SYSTEM EXPANSION AND RENOVATION PROJECT PHASE 2**

Item No.	Description	Qty.	Unit	Currency	Supply of Equipment				Local Transportation, Construction and Installation			
					Foreign Supply		Local Supply		Ex-works Price (excluding VAT) Baht		(excluding VAT) Baht	
					CIF Thai Port							
					Unit Price	Amount	Unit Price	Amount	Unit Price	Amount		
1AB20-1	230 kV and below Compression connector as per Specification attached	Lump sum	Lump sum				55,129.80	55,129.80	XXXXX	XXXXX		
1AB20-2	230 kV and below Miscellaneous hardware as per Specification attached	Lump sum	Lump sum				39,601.12	39,601.12	XXXXX	XXXXX		
1AB20-3	Cost of Local Transportation, Construction and Installation for Item No. 1AB20-1 thru 1AB20-2	Lump sum	Lump sum		XXXXX	XXXXX	XXXXX	XXXXX	35,524.10	35,524.10		
<b>Total Price for Schedule 1AB20</b>							<b>Baht 94,730.92</b>		<b>Baht 35,524.10</b>			



นางสุตารัตน์ ไชยพันธุ์  
 ผู้อำนวยการฝ่ายวิศวกรรมระบบส่ง  
 31 Aug 2022



นางสาวอาสยา ช่างวิทยากา  
 ทจตส-ท.  
 21 ก.ย. 2565

**MEDIUM COST FOR BID NO. RTS2-S-09**

**1AB21 : Bus Fitting**

**SUPPLY AND CONSTRUCTION OF 230 KV BHUMIBOL SUBSTATION (GIS)  
TRANSMISSION SYSTEM EXPANSION AND RENOVATION PROJECT PHASE 2**

Item No.	Description	Qty.	Unit	Currency	Supply of Equipment				Local Transportation, Construction and Installation (excluding VAT) Baht			
					Foreign Supply		Local Supply		Ex-works Price (excluding VAT) Baht			
					CIF Thai Port							
					Unit Price	Amount	Unit Price	Amount	Unit Price	Amount		
1AB21-1	230 kV and below Bus fitting as per Specification attached	Lump sum	Lump sum	THB	105,930.79	105,930.79			XXXXX	XXXXX		
1AB21-2	Cost of Local Transportation, Construction and Installation for Item No. 1AB21-1	Lump sum	Lump sum		XXXXX	XXXXX	XXXXX	XXXXX	39,724.05	39,724.05		
				<b>THB</b>	<b>105,930.79</b>		<b>Baht</b>		<b>Baht</b>			
<b>Total Price for Schedule 1AB21</b>									<b>39,724.05</b>			



นางสุตารัตน์ ไชยพันธุ์  
ผู้อำนวยการฝ่ายวิศวกรรมระบบส่ง

31 Aug 2022



นางสาวอัสยา ช่างวิทยากร  
หจก.ส.ท.

21 ก.ย. 2565

  
 นางสาวอาสยา ช่างวิทยากาน  
 พจตส-ท.  
 21 ก.ย. 2565

**MEDIUM COST FOR BID NO. RTS2-S-09**  
**1AB22 : Grounding Material**  
**SUPPLY AND CONSTRUCTION OF 230 KV BHUMIBOL SUBSTATION (GIS)**  
**TRANSMISSION SYSTEM EXPANSION AND RENOVATION PROJECT PHASE 2**

Item No.	Description	Qty.	Unit	Currency	Supply of Equipment				Local Transportation, Construction and Installation (excluding VAT) Baht			
					Foreign Supply		Local Supply		Ex-works Price (excluding VAT) Baht			
					CIF Thai Port							
					Unit Price	Amount	Unit Price	Amount	Unit Price	Amount		
1AB22-1	Ground rod as per Specification attached	Lump sum	Lump sum	THB	98,782.12	98,782.12			XXXXX	XXXXX		
1AB22-2	Thermite welding material as per Specification attached	Lump sum	Lump sum				427,262.56	427,262.56	XXXXX	XXXXX		
1AB22-3	Grounding hardware as per Specification attached	Lump sum	Lump sum	THB	290,832.83	290,832.83			XXXXX	XXXXX		
1AB22-4	Portable temporary grounding tools for maintenance as per Specification attached	1	set	THB	430,080.02	430,080.02			XXXXX	XXXXX		
1AB22-5	Cost of Local Transportation, Construction and Installation for Item No. 1AB22-1 thru 1AB22-4	Lump sum	Lump sum		XXXXXX	XXXXXX	XXXXXX	XXXXXX	467,609.07	467,609.07		
				<b>THB</b>	<b>819,694.97</b>		<b>Baht</b>					
							<b>427,262.56</b>		<b>Baht</b>			
									<b>467,609.07</b>			
<b>Total Price for Schedule 1AB22</b>												

  
 นางสุตารัตน์ ไชยพันธุ์  
 ผู้อำนวยการฝ่ายวิศวกรรมระบบส่ง  
 31 Aug 2022

**MEDIUM COST FOR BID NO. RTS2-S-09**  
**1AB23 : Substation Miscellaneous**  
**SUPPLY AND CONSTRUCTION OF 230 KV BHUMIBOL SUBSTATION (GIS)**  
**TRANSMISSION SYSTEM EXPANSION AND RENOVATION PROJECT PHASE 2**

Item No.	Description	Qty.	Unit	Currency	Supply of Equipment				Local Transportation, Construction and Installation (excluding VAT) Baht			
					Foreign Supply		Local Supply		Unit Price	Amount	Unit Price	Amount
					CIF Thai Port		Ex-works Price (excluding VAT) Baht					
					Unit Price	Amount	Unit Price	Amount	Unit Price	Amount		
1AB23-1	Rigid steel conduit as per Specification attached	Lump sum	Lump sum				9,970.40	9,970.40	XXXXX	XXXXX		
1AB23-2	Fitting for rigid steel conduit as per Specification attached	Lump sum	Lump sum	THB	5,192.00	5,192.00			XXXXX	XXXXX		
1AB23-3	HDPE conduit and fitting as per Specification attached	Lump sum	Lump sum				567.40	567.40	XXXXX	XXXXX		
1AB23-4	Heat shrinkable insulation material	Lump sum	Lump sum	THB	59,612.30	59,612.30			XXXXX	XXXXX		
1AB23-5	Identification and danger notice plate as per drawing attached	Lump sum	Lump sum				178,860.00	178,860.00	XXXXX	XXXXX		
1AB23-6	Cost of Local Transportation, Construction and Installation for Item No. 1AB23-1 thru 1AB23-5	Lump sum	Lump sum		XXXXX	XXXXX	XXXXX	XXXXX	95,325.79	95,325.79		
<b>Total Price for Schedule 1AB23</b>				<b>THB</b>	<b>64,804.30</b>		<b>Baht</b>	<b>189,397.80</b>		<b>Baht 95,325.79</b>		

  
 นางสุดารัตน์ ไชยพันธุ์  
 ผู้อำนวยการฝ่ายวิศวกรรมระบบส่ง  
 31 Aug 2022

  
 นางสาวอาสยา ช่างวิทยากา  
 ทจตส-ท.  
 21 ก.ย. 2565

**MEDIUM COST FOR BID NO. RTS2-S-09**  
**1AB24 : Control and Protection System**  
**SUPPLY AND CONSTRUCTION OF 230 KV BHUMIBOL SUBSTATION (GIS)**  
**TRANSMISSION SYSTEM EXPANSION AND RENOVATION PROJECT PHASE 2**

Item No.	Description	Drawing No. / Reference No.	Qty.	Unit	Currency	Supply of Equipment				Local Transportation, Construction and Installation (excluding VAT) Baht			
						Foreign Supply		Local Supply					
						CIF Thai Port		Ex-works Price (excluding VAT) Baht		Unit Price	Amount	Unit Price	Amount
						Unit Price	Amount	Unit Price	Amount				
1AB24-1	DIGITAL SUBSTATION SYSTEM -- Protective IED Panel (For 230kV BUS NO.1 & NO.2 PROTECTION)	Panel No. 1R Specification No. 1008 See Scope of Work and Note Drawing Nos. BB-E-1 sh.1-4, BB-E-2.1 sh.1-2, BB-E-2.2 sh.1-2, BB-E-3.1 sh.1-2, BB-E-3.2, TP-E-10.1 and TP-E-20.3	1	Ea				5,251,218	5,251,218.00	XXXXX	XXXXX		
1AB24-2	DIGITAL SUBSTATION SYSTEM -- Protective IED Panel (For 230kV Line NO.1&2 to BB Hydro Power Plant and Line NO.1 to TAK2)	Panel No. 2R Specification No. 1008 See Scope of Work and Note Drawing Nos. BB-E-1 sh.1-4, BB-E-2.1 sh.1-2, BB-E-2.2 sh.1-2, BB-E-3.1 sh.1-2, BB-E-3.2, TP-E-10.1 and TP-E-20.3	1	Ea				5,185,798	5,185,798.00	XXXXX	XXXXX		



นางสุตารัตน์ ไชยพันธุ์  
ผู้อำนวยการฝ่ายวิศวกรรมระบบส่ง

31 Aug 2022

นางสาวอัสยา ช่างวิทยากร  
หจคส-ท.  
21 ก.ย. 2565

**MEDIUM COST FOR BID NO. RTS2-S-09**  
**1AB24 : Control and Protection System**  
**SUPPLY AND CONSTRUCTION OF 230 KV BHUMIBOL SUBSTATION (GIS)**  
**TRANSMISSION SYSTEM EXPANSION AND RENOVATION PROJECT PHASE 2**

Item No.	Description	Drawing No. / Reference No.	Qty.	Unit	Currency	Supply of Equipment				Local Transportation, Construction and Installation (excluding VAT) Baht			
						Foreign Supply		Local Supply					
						CIF Thai Port		Ex-works Price (excluding VAT) Baht		Unit Price	Amount	Unit Price	Amount
						Unit Price	Amount	Unit Price	Amount				
1AB24-3	DIGITAL SUBSTATION SYSTEM -- Protective IED Panel (For 230kV Line NO.1&2 to BB Floating Solar and Line NO.2 to TAK2)	Panel No. 3R Specification No. 1008 See Scope of Work and Note Drawing Nos. BB-E-1 sh.1-4, BB-E-2.1 sh.1-2, BB-E-2.2 sh.1-2, BB-E-3.1 sh.1-2, BB-E-3.2, TP-E-10.1 and TP-E-20.3	1	Ea				4,703,004	4,703,004.00	XXXXX	XXXXX		
1AB24-4	DIGITAL SUBSTATION SYSTEM -- Protective IED Panel (For 230/115 kV KT1A & KT2A )	Panel No. 4R Specification No. 1008 See Scope of Work and Note Drawing Nos. BB-E-1 sh.1-4, BB-E-2.1 sh.1-2, BB-E-2.2 sh.1-2, BB-E-3.1 sh.1-2, BB-E-3.2, TP-E-10.1 and TP-E-20.3	1	Ea				3,609,621	3,609,621.00	XXXXX	XXXXX		

  
 นางสุตารัตน์ ไชยพันธุ์  
 ผู้อำนวยการฝ่ายวิศวกรรมระบบส่ง

31 Aug 2022

  
 นางสาวอัสยา ช่างวิทยากร  
 หจกส-ท.  
 21 ก.ย. 2565



**MEDIUM COST FOR BID NO. RTS2-S-09**  
**1AB24 : Control and Protection System**  
**SUPPLY AND CONSTRUCTION OF 230 KV BHUMIBOL SUBSTATION (GIS)**  
**TRANSMISSION SYSTEM EXPANSION AND RENOVATION PROJECT PHASE 2**

Item No.	Description	Drawing No. / Reference No.	Qty.	Unit	Currency	Supply of Equipment				Local Transportation, Construction and Installation (excluding VAT) Baht			
						Foreign Supply		Local Supply					
						CIF Thai Port		Ex-works Price (excluding VAT) Baht		Unit Price	Amount	Unit Price	Amount
						Unit Price	Amount	Unit Price	Amount				
1AB24-5	DIGITAL SUBSTATION SYSTEM -- BCU Panel	Panel No. BCU-1 Specification No. 1008 See Scope of Work and Note Drawing Nos. BB-E-1 sh.1-4, BB-E-2.1 sh.1-2, BB-E-2.2 sh.1-2, BB-E-3.1 sh.1-2, BB-E-3.2, TP-E-10.1 and TP-E-20.3	1	Ea				2,070,056	2,070,056.00	XXXXX	XXXXX		
1AB24-6	DIGITAL SUBSTATION SYSTEM -- BCU Panel	Panel No. BCU-2 and BCU-3 Specification No. 1008 See Scope of Work and Note Drawing Nos. BB-E-1 sh.1-4, BB-E-2.1 sh.1-2, BB-E-2.2 sh.1-2, BB-E-3.1 sh.1-2, BB-E-3.2, TP-E-10.1 and TP-E-20.3	2	Ea				3,495,547	6,991,094.00	XXXXX	XXXXX		



นางสุดารัตน์ ไชยพันธุ์  
 ผู้อำนวยการฝ่ายวิศวกรรมระบบส่ง

31 Aug 2022



นางสาวอาสยา ช่างวิทยากร  
 หจก.ส.ท.

21 ก.ย. 2565

**MEDIUM COST FOR BID NO. RTS2-S-09**  
**1AB24 : Control and Protection System**  
**SUPPLY AND CONSTRUCTION OF 230 KV BHUMIBOL SUBSTATION (GIS)**  
**TRANSMISSION SYSTEM EXPANSION AND RENOVATION PROJECT PHASE 2**

Item No.	Description	Drawing No. / Reference No.	Qty.	Unit	Currency	Supply of Equipment				Local Transportation, Construction and Installation (excluding VAT) Baht			
						Foreign Supply		Local Supply					
						CIF Thai Port		Ex-works Price (excluding VAT) Baht		Unit Price	Amount	Unit Price	Amount
						Unit Price	Amount	Unit Price	Amount				
1AB24-7	DIGITAL SUBSTATION SYSTEM -- GPS AND GATEWAY PANEL	Panel No. GPS AND GATEWAY Specification No. 1008 See Scope of Work Drawing Nos. BB-E-1 sh.1-4, BB-E-2.1 sh.1-2, BB-E-2.2 sh.1-2, BB-E-3.1 sh.1-2, BB-E-3.2, TP-E-10.19 and TP-E-20.3	1	Ea				1,207,056	1,207,056.00	XXXXX	XXXXX		
1AB24-8	DIGITAL SUBSTATION SYSTEM -- E1 CONVERTER PANEL	Panel No. E1 CONVERTER-1 Specification No. 1008 See Scope of Work Drawing Nos. BB-E-1 sh.1-4, BB-E-2.1 sh.1-2, BB-E-2.2 sh.1-2, BB-E-3.1 sh.1-2, BB-E-3.2, TP-E-10.20 and TP-E-20.3	1	Ea				1,278,446	1,278,446.00	XXXXX	XXXXX		

  
 นางสุตารัตน์ ไชยพันธุ์  
 ผู้อำนวยการฝ่ายวิศวกรรมระบบส่ง

31 Aug 2022

  
 นางสาวอาสยา ช่างวิทยากร  
 วิศวกร-ท.  
 21 ก.ย. 2565

  
 นางสาวอศยา ช่างวิทยากา  
 หจตส-ท.  
 21 ก.ย. 2565

**MEDIUM COST FOR BID NO. RTS2-S-09**  
**1AB24 : Control and Protection System**  
**SUPPLY AND CONSTRUCTION OF 230 KV BHUMIBOL SUBSTATION (GIS)**  
**TRANSMISSION SYSTEM EXPANSION AND RENOVATION PROJECT PHASE 2**

Item No.	Description	Drawing No. / Reference No.	Qty.	Unit	Currency	Supply of Equipment				Local Transportation, Construction and Installation (excluding VAT) Baht			
						Foreign Supply		Local Supply					
						CIF Thai Port		Ex-works Price (excluding VAT) Baht		Unit Price	Amount	Unit Price	Amount
						Unit Price	Amount	Unit Price	Amount				
1AB24-9	DIGITAL SUBSTATION SYSTEM -- E1 CONVERTER PANEL	Panel No. E1 CONVERTER-2 Specification No. 1008 See Scope of Work Drawing Nos. BB-E-1 sh.1-4, BB-E-2.1 sh.1-2, BB-E-2.2 sh.1-2, BB-E-3.1 sh.1-2, BB-E-3.2, TP-E-10.20 and TP-E-20.3	1	Ea				715,944	715,944.00	XXXXXX	XXXXXX		
1AB24-10	DIGITAL SUBSTATION SYSTEM -- PROCESS BUS ETHERNET SWITCH PANEL (FOR PROCESS BUS#A)	For Process Bus#A (Ports of Ethernet Switch shall not be less than 200 ports) Specification No. 1008 See Scope of Work Drawing Nos. BB-E-1 sh.1-4, BB-E-2.1 sh.1-2, BB-E-2.2 sh.1-2, BB-E-3.1 sh.1-2, BB-E-3.2, TP-E-10.19, TP-E-20.3 and TP-E-20.6 sh.1	1	SET				4,772,910	4,772,910.00	XXXXXX	XXXXXX		

นางสุดารัตน์ ไชยพันธุ์  
ผู้อำนวยการฝ่ายวิศวกรรมระบบส่ง

31 Aug 2022

**MEDIUM COST FOR BID NO. RTS2-S-09**  
**1AB24 : Control and Protection System**  
**SUPPLY AND CONSTRUCTION OF 230 KV BHUMIBOL SUBSTATION (GIS)**  
**TRANSMISSION SYSTEM EXPANSION AND RENOVATION PROJECT PHASE 2**

Item No.	Description	Drawing No. / Reference No.	Qty.	Unit	Currency	Supply of Equipment				Local Transportation, Construction and Installation (excluding VAT) Baht			
						Foreign Supply		Local Supply					
						CIF Thai Port		Ex-works Price (excluding VAT) Baht		Unit Price	Amount	Unit Price	Amount
						Unit Price	Amount	Unit Price	Amount				
1AB24-11	DIGITAL SUBSTATION SYSTEM -- PROCESS BUS ETHERNET SWITCH PANEL (FOR PROCESS BUS#B)	For Process Bus#B (Ports of Ethernet Switch shall not be less than 200 ports) Specification No. 1008 See Scope of Work Drawing Nos. BB-E-1 sh.1-4, BB-E-2.1 sh.1-2, BB-E-2.2 sh.1-2, BB-E-3.1 sh.1-2, BB-E-3.2, TP-E-10.19, TP-E-20.3 and TP-E-20.6 sh.1	1	SET				4,772,910	4,772,910.00	XXXXX	XXXXX		

  
 นางสุดารัตน์ ไชยพันธุ์  
 ผู้อำนวยการฝ่ายวิศวกรรมระบบส่ง  
 31 Aug 2022

  
 นางสาวอัสยา ช่างวิทยากาฬ  
 หจคส-ท.  
 21 ก.ย. 2565

**MEDIUM COST FOR BID NO. RTS2-S-09**  
**1AB24 : Control and Protection System**  
**SUPPLY AND CONSTRUCTION OF 230 KV BHUMIBOL SUBSTATION (GIS)**  
**TRANSMISSION SYSTEM EXPANSION AND RENOVATION PROJECT PHASE 2**

Item No.	Description	Drawing No. / Reference No.	Qty.	Unit	Currency	Supply of Equipment				Local Transportation, Construction and Installation (excluding VAT) Baht			
						Foreign Supply		Local Supply					
						CIF Thai Port		Ex-works Price (excluding VAT) Baht		Unit Price	Amount	Unit Price	Amount
						Unit Price	Amount	Unit Price	Amount				
1AB24-12	DIGITAL SUBSTATION SYSTEM -- STATION BUS ETHERNET SWITCH PANEL	Panel ESW-S (Ports of Ethernet Switch shall not be less than 88 ports for Station Bus#A and Ports of Ethernet Switch shall not be less than 88 ports for Station Bus#B) Specification No. 1008 See Scope of Work Drawing Nos. Drawing Nos. BB-E-1 sh.1-4, BB-E-2.1 sh.1-2, BB-E-2.2 sh.1-2, BB-E-3.1 sh.1-2, BB-E-3.2, TP-E-10.19, TP-E-20.3 and TP-E-20.6	1	SET					4,253,602	4,253,602.00	XXXXX	XXXXX	



นางสุดารัตน์ ไชยพันธุ์  
ผู้อำนวยการฝ่ายวิศวกรรมระบบส่ง

31 Aug 2022

นางสาวอสาชา ช่างวิทยากา

หงตส-ท.

21 ก.ย. 2565

**MEDIUM COST FOR BID NO. RTS2-S-09**  
**1AB24 : Control and Protection System**  
**SUPPLY AND CONSTRUCTION OF 230 KV BHUMIBOL SUBSTATION (GIS)**  
**TRANSMISSION SYSTEM EXPANSION AND RENOVATION PROJECT PHASE 2**

อราน ชินฉันทาน  
 นางสาวอรานา ช่างวิทยากาน  
 หจกส-ท.  
 21 ก.ย. 2565

Item No.	Description	Drawing No. / Reference No.	Qty.	Unit	Currency	Supply of Equipment				Local Transportation, Construction and Installation (excluding VAT) Baht			
						Foreign Supply		Local Supply					
						CIF Thai Port		Ex-works Price (excluding VAT) Baht		Unit Price	Amount	Unit Price	Amount
						Unit Price	Amount	Unit Price	Amount				
1AB24-13	DIGITAL SUBSTATION SYSTEM -- Patch Cord Cable	For Network System Specification No. 1008 See Scope of Work Drawing Nos. BB-E-1 sh.1-4, BB-E-2.1 sh.1-2, BB-E-2.2 sh.1-2, BB-E-3.1 sh.1-2, BB-E-3.2, BB-S-6 and TP-E-20.3	1	LOT				1,653,000	1,653,000.00	XXXXX	XXXXX		
1AB24-14	DIGITAL SUBSTATION SYSTEM -- 12 CORE METALLIC OPTICAL FIBER CABLE (MULTIMODE)	Specification No. 1008 See Scope of Work Drawing Nos. BB-E-1 sh.1-4, BB-E-2.1 sh.1-2, BB-E-2.2 sh.1-2, BB-E-3.1 sh.1-2, BB-E-3.2 and TP-E-20.3 The length of OFC that connects between Merging Panel and other Panels at Control Building shall conform to Drawing Nos. BB-S-2, BB-S-6 and BB-S-7	1	LOT				928,000	928,000.00	XXXXX	XXXXX		

นางสุดารัตน์ ไชยพันธุ์  
 ผู้อำนวยการฝ่ายวิศวกรรมระบบส่ง

31 Aug 2022

นางสาวอัสยา ช่างวิทยากร  
 หนจตส-ท.  
 21 ก.ย. 2565

**MEDIUM COST FOR BID NO. RTS2-S-09**  
**1AB24 : Control and Protection System**  
**SUPPLY AND CONSTRUCTION OF 230 KV BHUMIBOL SUBSTATION (GIS)**  
**TRANSMISSION SYSTEM EXPANSION AND RENOVATION PROJECT PHASE 2**

Item No.	Description	Drawing No. / Reference No.	Qty.	Unit	Currency	Supply of Equipment				Local Transportation, Construction and Installation (excluding VAT) Baht			
						Foreign Supply		Local Supply					
						CIF Thai Port		Ex-works Price (excluding VAT) Baht		Unit Price	Amount	Unit Price	Amount
						Unit Price	Amount	Unit Price	Amount				
1AB24-15	EFLEX AND/OR HDPE CONDUIT WITH HOT-DIP GALVANIZED STEEL CLAMP	See Scope of Work Specification No. SD-FOT-P22 Supplied with Hot-Dip Galvanized Steel Clamp 1 Set per 1 Meter of Conduit. Drawing Nos. BB-E-1 sh.1-4, BB-E-2.1 sh.1-2, BB-E-2.2 sh.1-2, BB-E-3.1 sh.1-2, BB-E-3.2 and TP-E-20.3 The length of EFLEX that connects between Merging Panel and other Panels at Control Building shall conform to Drawing Nos. BB-S-2, BB-S-6 and BB-S-7	1	LOT				428,800	428,800.00	XXXXX	XXXXX		



นางสุตารัตน์ ไชยพันธุ์  
 ผู้อำนวยการฝ่ายวิศวกรรมระบบส่ง

31 Aug 2022

**MEDIUM COST FOR BID NO. RTS2-S-09**  
**1AB24 : Control and Protection System**  
**SUPPLY AND CONSTRUCTION OF 230 KV BHUMIBOL SUBSTATION (GIS)**  
**TRANSMISSION SYSTEM EXPANSION AND RENOVATION PROJECT PHASE 2**

Item No.	Description	Drawing No. / Reference No.	Qty.	Unit	Currency	Supply of Equipment				Local Transportation, Construction and Installation (excluding VAT) Baht			
						Foreign Supply		Local Supply					
						CIF Thai Port		Ex-works Price (excluding VAT) Baht		Unit Price	Amount	Unit Price	Amount
						Unit Price	Amount	Unit Price	Amount				
1AB24-16	DIGITAL SUBSTATION SYSTEM -- Station Level	Including - IEC61850 Engineering Workstation - IEC61850 HMI Server - Operator Console (Desk and Chair) - Computer Set - Software - Redundant Box - Inverter Specification No. 1008 Drawing Nos. TP-E-20.8 sh.1-3	1	SET					2,402,215	2,402,215.00	XXXXXX	XXXXXX	

  
 นางสาวดารัตน์ ไชยพันธุ์  
 ผู้อำนวยการฝ่ายวิศวกรรมระบบส่ง  
 31 Aug 2022

  
 นางสาวอาสยา ช่างวิทยากา  
 หจตส-ท.  
 21 ก.ย. 2565



**MEDIUM COST FOR BID NO. RTS2-S-09**  
**1AB24 : Control and Protection System**  
**SUPPLY AND CONSTRUCTION OF 230 KV BHUMIBOL SUBSTATION (GIS)**  
**TRANSMISSION SYSTEM EXPANSION AND RENOVATION PROJECT PHASE 2**

Item No.	Description	Drawing No. / Reference No.	Qty.	Unit	Currency	Supply of Equipment				Local Transportation, Construction and Installation (excluding VAT) Baht		
						Foreign Supply		Local Supply				
						CIF Thai Port		Ex-works Price (excluding VAT) Baht				
						Unit Price	Amount	Unit Price	Amount	Unit Price	Amount	
1AB24-17	DIGITAL SUBSTATION SYSTEM -- Merging Unit Panel (for GIS:1-BKR, 3-DS, 1-CT, 1-VT)	Panel Nos. MUC800-1, MUC801-1, MUC801-3, MUC801-4, MUC802-1 to MUC802-3, MUC803-1 to MUC803-3 and MUC804-1 to MU804-3 Specification No. 1008 See Scope of Work and Note Drawing Nos. BB-E-1 sh.1-4, BB-E-2.1 sh.1-2, BB-E-2.2 sh.1-2, BB-E-3.1 sh.1-2 and BB-E-3.2	13	Ea					2,979,445	38,732,785.00	XXXXXX	XXXXXX

  
 นางสุดารัตน์ ไชยพันธุ์  
 ผู้อำนวยการฝ่ายวิศวกรรมระบบส่ง  
 31 Aug 2022

  
 นางสาวอาสยา ช่างวิทยากา  
 หจตส-ท.  
 21 ก.ย. 2565

**MEDIUM COST FOR BID NO. RTS2-S-09**  
**1AB24 : Control and Protection System**  
**SUPPLY AND CONSTRUCTION OF 230 KV BHUMIBOL SUBSTATION (GIS)**  
**TRANSMISSION SYSTEM EXPANSION AND RENOVATION PROJECT PHASE 2**

Item No.	Description	Drawing No. / Reference No.	Qty.	Unit	Currency	Supply of Equipment				Local Transportation, Construction and Installation (excluding VAT) Baht			
						Foreign Supply		Local Supply					
						CIF Thai Port		Ex-works Price (excluding VAT) Baht		Unit Price	Amount	Unit Price	Amount
						Unit Price	Amount	Unit Price	Amount				
1AB24-18	DIGITAL SUBSTATION SYSTEM -- Merging Unit Panel (for 1-TX)	Panel Nos. MUC801-2 and MUC802-4 Specification No. 1008 See Scope of Work and Note Drawing Nos. BB-E-1 sh.1-4, BB-E-2.1 sh.1-2, BB-E-2.2 sh.1-2, BB-E-3.1 sh.1-2 and BB-E-3.2	2	Ea				2,143,743	4,287,486.00	XXXXX	XXXXX		
1AB24-19	DIGITAL SUBSTATION SYSTEM -- METERING PANEL (4 KWH&KVARH METERS)	Panel No. MP1 See Scope of Work Drawing Nos. Drawing Nos. BB-E-1 sh.1-4, BB-E-2.1 sh.1-2, BB-E-2.2 sh.1-2, BB-E-3.1 sh.1-2, BB-E-3.2 and TP-E-10.1	1	Ea				1,466,234	1,466,234.00	XXXXX	XXXXX		

  
 นางสุดารัตน์ ไชยพันธุ์  
 ผู้อำนวยการฝ่ายวิศวกรรมระบบส่ง

31 Aug 2022

อาน ชีวจินทร  
 นางสาวอานยา ช่างวิทยากา  
 วิศวกร-ท.  
 21 ก.ย. 2565

**MEDIUM COST FOR BID NO. RTS2-S-09**  
**1AB24 : Control and Protection System**  
**SUPPLY AND CONSTRUCTION OF 230 KV BHUMIBOL SUBSTATION (GIS)**  
**TRANSMISSION SYSTEM EXPANSION AND RENOVATION PROJECT PHASE 2**

Item No.	Description	Drawing No. / Reference No.	Qty.	Unit	Currency	Supply of Equipment				Local Transportation, Construction and Installation (excluding VAT) Baht			
						Foreign Supply		Local Supply					
						CIF Thai Port		Ex-works Price (excluding VAT) Baht		Unit Price	Amount	Unit Price	Amount
						Unit Price	Amount	Unit Price	Amount				
1AB24-20	Cost of Local Transportation, Construction and Installation for Item No.1AB24-1 thru 1AB24-19		Lump sum	Lump sum		XXXXX	XXXXX	XXXXX	XXXXX	9,471,009.91	9,471,009.91		
<b>Total Price for Schedule 1AB24</b>								<b>Baht 94,710,179.00</b>		<b>Baht 9,471,009.91</b>			

  
 นางสุดารัตน์ ไชยพันธุ์  
 ผู้อำนวยการฝ่ายวิศวกรรมระบบส่ง  
 31 Aug 2022

  
 นางสาวอาสยา ช่างวิทยากาน  
 หจกส-ท.  
 21 ก.ย. 2565

**MEDIUM COST FOR BID NO. RTS2-S-09**  
**1AB24 : Control and Protection System**  
**SUPPLY AND CONSTRUCTION OF 230 KV BHUMIBOL SUBSTATION (GIS)**  
**TRANSMISSION SYSTEM EXPANSION AND RENOVATION PROJECT PHASE 2**

Item No.	Description	Drawing No. / Reference No.	Qty.	Unit	Currency	Supply of Equipment				Local Transportation, Construction and Installation (excluding VAT) Baht	
						Foreign Supply		Local Supply			
						CIF Thai Port		Ex-works Price (excluding VAT) Baht			
						Unit Price	Amount	Unit Price	Amount	Unit Price	Amount

Note \*\*\*Criteria for selection of devices

1. Protective IEDs
  - Primary protective IEDs shall be supplied by same manufacturer.
  - Secondary Protective IEDs shall be supplied by same manufacturer.
  - Primary and secondary protective IEDs shall be from different manufacturer.
2. BCUs
  - BCUs shall be supplied by the same manufacturer as either primary or secondary protective IEDs.
3. Merging Units
  - All primary merging unit shall be supplied by same manufacturer.
  - All secondary merging unit shall be supplied by same manufacturer.
  - Primary and secondary merging units are not necessary to be from different manufacturer.

  
 นางสาวอัสยา ขำวิททยาการ  
 ทจตส-ท.  
 21 ก.ย. 2565

  
 นางสุดารัตน์ ไชยพันธุ์  
 ผู้อำนวยการฝ่ายวิศวกรรมระบบส่ง  
 31 Aug 2022

**MEDIUM COST FOR BID NO. RTS2-S-09**  
**1AB25 : Fault Recording System**  
**SUPPLY AND CONSTRUCTION OF 230 KV BHUMIBOL SUBSTATION (GIS)**  
**TRANSMISSION SYSTEM EXPANSION AND RENOVATION PROJECT PHASE 2**

Item No.	Description	Drawing No. / Reference No.	Qty.	Unit	Currency	Supply of Equipment				Local Transportation, Construction and Installation (excluding VAT) Baht			
						Foreign Supply		Local Supply					
						CIF Thai Port		Ex-works Price (excluding VAT) Baht		Unit Price	Amount	Unit Price	Amount
						Unit Price	Amount	Unit Price	Amount				
1AB25-1	FAULT RECORDING SYSTEM, 64 ANALOG INPUT, 192 DIGITAL INPUT.	Installed at 230/115kV Relay Room. Specification Nos. 1003 and 1008 See Scope of Work Drawing Nos. BB-E-1 sh.1-4 and TP-E-20.3	1	SET					3,769,770.00	3,769,770.00	XXXXX	XXXXX	
1AB25-2	Cost of Local Transportation, Construction and Installation for Item No.1AB25-1		Lump sum	Lump sum					XXXXX	XXXXX	376,977.00	376,977.00	
<b>Total Price for Schedule 1AB25</b>									<b>Baht 3,769,770.00</b>		<b>Baht 376,977.00</b>		

  
นางสุตารัตน์ ไชยพันธุ์  
ผู้อำนวยการฝ่ายวิศวกรรมระบบส่ง

31 Aug 2022

  
นางสาวอาสยา ช่างวิทยากษ  
พจตส.พ.  
21 ก.ย. 2565

**MEDIUM COST FOR BID NO. RTS2-S-09**  
**1AB34 : 48 VDC Stationary Battery, Battery Charger and DC Power Panel**  
**SUPPLY AND CONSTRUCTION OF 230 KV BHUMIBOL SUBSTATION (GIS)**  
**TRANSMISSION SYSTEM EXPANSION AND RENOVATION PROJECT PHASE 2**

Item No.	Description	Qty.	Unit	Currency	Supply of Equipment				Local Transportation, Construction and Installation (excluding VAT) Baht			
					Foreign Supply		Local Supply					
					CIF Thai Port		Ex-works Price (excluding VAT) Baht		Unit Price	Amount	Unit Price	Amount
					Unit Price	Amount	Unit Price	Amount				
1AB34-1	Vented type lead-acid stationary battery 48 VDC with capacity not less than 600 Ah (Tubular plate) at 10-hour rated, 24 cells, nominal voltage 2 volts/cell, with rack 1 set (230/115 kV Bhumibol GIS - 1 set)	1	SET				367,000.00	367,000.00	XXXXXX	XXXXXX		
1AB34-2	Conventional type charger 48 VDC, 150 A (230/115 kV Bhumibol GIS - 2 set)	2	SET				414,000.00	828,000.00	XXXXXX	XXXXXX		
1AB34-3	48 VDC load center type 1-60 breaker (230/115 kV Bhumibol GIS - 1 set)	1	SET				154,000.00	154,000.00	XXXXXX	XXXXXX		
1AB34-4	Local Transportation, Construction and Installation for Item No. 1AB34-1, 1AB34-2 and 1AB34-3	1	JOB			XXXXXX	XXXXXX	XXXXXX	116,000.00	116,000.00		
<b>Total Price for Schedule 1AB34</b>							<b>Baht</b>	<b>1,349,000.00</b>	<b>Baht</b>	<b>116,000.00</b>		

  
 นางสุตารัตน์ ไชยพันธุ์  
 ผู้อำนวยการฝ่ายวิศวกรรมระบบส่ง  
 31 Aug 2022

อาน ชิงจินนาร  
 นางสาวอานทยา ช่างวิทยากร  
 ทจคส-ท.  
 21 ก.ย. 2565

01/08/2022  
 นางสาวอาสยา ช่างวิทยากร  
 ทจตส-ท.  
 21 ก.ย. 2565

**MEDIUM COST FOR BID NO. RTS2-S-09**  
**1AB35 : Communication Cable**  
**SUPPLY AND CONSTRUCTION OF 230 KV BHUMIBOL SUBSTATION (GIS)**  
**TRANSMISSION SYSTEM EXPANSION AND RENOVATION PROJECT PHASE 2**

Item No.	Description	Qty.	Unit	Currency	Supply of Equipment				Local Transportation, Construction and Installation (excluding VAT) Baht			
					Foreign Supply		Local Supply		Unit Price	Amount	Unit Price	Amount
					CIF Thai Port		Ex-works Price (excluding VAT) Baht					
					Unit Price	Amount	Unit Price	Amount	Unit Price	Amount		
<b>1AB35-1</b>	<b>Optical fiber cable from joint box at TAK1 take-off structure to fiber frame termination cabinet at 230/115 kV Bhumibol substation (GIS)</b>											
1AB35-1.1	Supply of optical fiber cable and accessories including: (a) 36-core non-metallic optical fiber cable (approx. 350 meters) (b) Rigid steel conduit from take-off structure to cable trench (lump sum) (c) EFLEX and/or HDPE conduit with hot-dip galvanized steel clamp (lump sum) (d) Rack cabinet and accessories (230/115 kV Bhumibol substation (GIS) - 1 set) (e) Fiber frame termination cabinet with cable tray (230/115 kV Bhumibol substation (GIS) - 1 set) (f) 36 pigtailed (1.5 meter) (230/115 kV Bhumibol substation (GIS) - 1 set) (g) 6-wire cleat for coiling optical fiber cable at take-off structure (4 sets)	1	LOT					124,070.00	124,070.00	XXXXXX	XXXXXX	
1AB35-1.2	Local transportation, Construction and Installation for item 1AB35-1.1 (Including splicing work and field testing for optical fiber)	1	JOB							203,920.00	203,920.00	

  
 นางสุตารัตน์ ไชยพันธุ์  
 ผู้อำนวยการฝ่ายวิศวกรรมระบบส่ง  
 31 Aug 2022

**MEDIUM COST FOR BID NO. RTS2-S-09**  
**1AB35 : Communication Cable**  
**SUPPLY AND CONSTRUCTION OF 230 KV BHUMIBOL SUBSTATION (GIS)**  
**TRANSMISSION SYSTEM EXPANSION AND RENOVATION PROJECT PHASE 2**

Item No.	Description	Qty.	Unit	Currency	Supply of Equipment				Local Transportation, Construction and Installation			
					Foreign Supply		Local Supply		Ex-works Price (excluding VAT) Baht		(excluding VAT) Baht	
					CIF Thai Port							
					Unit Price	Amount	Unit Price	Amount	Unit Price	Amount		
1AB35-2	<b>Optical fiber cable from joint box at Bhumibol Hydro Power Plant Line No.1 take-off structure to fiber frame termination cabinet at 230/115 kV Bhumibol substation (GIS)</b>											
1AB35-2.1	Supply of optical fiber cable and accessories including: (a) 36-core non-metallic optical fiber cable (approx. 300 meters) (b) Rigid steel conduit from take-off structure to cable trench (lump sum) (c) EFLEX and/or HDPE conduit with hot-dip galvanized steel clamp (lump sum) (d) Rack cabinet and accessories (230/115 kV Bhumibol substation (GIS) - 1 set) (e) Fiber frame termination cabinet with cable tray (230/115 kV Bhumibol substation (GIS) - 1 set) (f) 36 pigtailes (1.5 meter) (230/115 kV Bhumibol substation (GIS) - 1 set) (g) 6-wire cleat for coiling optical fiber cable at take-off structure (4 sets)	1	LOT					113,570.00	113,570.00	XXXXX	XXXXX	
1AB35-2.2	Local transportation, Construction and Installation for item 1AB35-2.1 (Including splicing work and field testing for optical fiber)	1	JOB					XXXXX	XXXXX	XXXXX	XXXXX	
										187,420.00	187,420.00	

  
 นางสุตารัตน์ ไชยพันธุ์  
 ผู้อำนวยการฝ่ายวิศวกรรมระบบส่ง

31 Aug 2022

  
 นางสาวอาสยา ช่างวิทยากร  
 ทจคส-ท.  
 21 ก.ย. 2565



**MEDIUM COST FOR BID NO. RTS2-S-09**  
**1AB35 : Communication Cable**  
**SUPPLY AND CONSTRUCTION OF 230 KV BHUMIBOL SUBSTATION (GIS)**  
**TRANSMISSION SYSTEM EXPANSION AND RENOVATION PROJECT PHASE 2**

Item No.	Description	Qty.	Unit	Currency	Supply of Equipment				Local Transportation, Construction and Installation (excluding VAT) Baht			
					Foreign Supply		Local Supply		Unit Price	Amount	Unit Price	Amount
					CIF Thai Port		Ex-works Price (excluding VAT) Baht					
					Unit Price	Amount	Unit Price	Amount	Unit Price	Amount		
1AB35-3 1AB35-3.1	<b>Optical fiber cable from joint box at Bhumibol Hydro Power Plant Line No.2 take-off structure to fiber frame termination cabinet at 230/115 kV Bhumibol substation (GIS)</b> Supply of optical fiber cable and accessories including: (a) 36-core non-metallic optical fiber cable (approx. 300 meters) (b) Rigid steel conduit from take-off structure to cable trench (lump sum) (c) EFLEX and/or HDPE conduit with hot-dip galvanized steel clamp (lump sum) (d) Fiber frame termination cabinet with cable tray (230/115 kV Bhumibol substation (GIS) - 1 set) (e) 36 pigtailed (1.5 meter) (230/115 kV Bhumibol substation (GIS) - 1 set) (f) 6-wire cleat for coiling optical fiber cable at take-off structure (4 sets)	1	LOT					91,910.00	91,910.00	XXXXXX	XXXXXX	

  
 นางสุดารัตน์ ไชยพันธุ์  
 ผู้อำนวยการฝ่ายวิศวกรรมระบบส่ง  
 31 Aug 2022

  
 นางสาวอสาชา ช่างวิทยากา  
 ทดตส-ท.  
 21 ก.ย. 2565

**MEDIUM COST FOR BID NO. RTS2-S-09**  
**1AB35 : Communication Cable**  
**SUPPLY AND CONSTRUCTION OF 230 KV BHUMIBOL SUBSTATION (GIS)**  
**TRANSMISSION SYSTEM EXPANSION AND RENOVATION PROJECT PHASE 2**

Item No.	Description	Qty.	Unit	Currency	Supply of Equipment				Local Transportation, Construction and Installation (excluding VAT) Baht			
					Foreign Supply		Local Supply		Unit Price	Amount	Unit Price	Amount
					CIF Thai Port		Ex-works Price (excluding VAT) Baht					
					Unit Price	Amount	Unit Price	Amount	Unit Price	Amount		
1AB35-3.2	Local transportation, Construction and Installation for item 1AB35-3.1 (Including splicing work and field testing for optical fiber)	1	JOB		XXXXXX	XXXXXX	XXXXXX	XXXXXX	177,790.00	177,790.00		
	IMPORTANT: 1. Telecommunication Equipment supplied under Schedule AB35 shall conform to Telecommunication Equipment Specification: Single Sheath Non-metallic Optical Fiber Cable (SD-FOT-P22). 2. The Bidder is required to later break down the unit price for sub-items of this Schedule for consideration.											
<b>Total Price for Schedule 1AB35</b>								<b>Baht</b>	<b>329,550.00</b>	<b>Baht</b>	<b>569,130.00</b>	

  
 นางสุตารัตน์ ไชยพันธุ์  
 ผู้อำนวยการฝ่ายวิศวกรรมระบบส่ง  
 31 Aug 2022

  
 นางสาวอาสยา ช่างวิทยากร  
 ทจคส-ท.  
 21 ก.ย. 2565

นางสาวอภิสยา ช่างวิทยากา  
 วิศวกร  
 21 ก.ย. 2565

**MEDIUM COST FOR BID NO. RTS2-S-09**  
**1AB39 : Commissioning**  
**SUPPLY AND CONSTRUCTION OF 230 KV BHUMIBOL SUBSTATION (GIS)**  
**TRANSMISSION SYSTEM EXPANSION AND RENOVATION PROJECT PHASE 2**

Item No.	Description	Qty.	Unit	Currency	Supply of Equipment				Local Transportation, Construction and Installation (excluding VAT) Baht			
					Foreign Supply		Local Supply		Unit Price	Amount	Unit Price	Amount
					CIF Thai Port		Ex-works Price (excluding VAT) Baht					
					Unit Price	Amount	Unit Price	Amount	Unit Price	Amount		
1AB39-1	Commissioning	Lump sum	Lump sum		XXXXX	XXXXX	XXXXX	XXXXX	1,200,000.00	1,200,000.00		
<b>Total Price for Schedule 1AB39</b>							<b>Baht</b>		<b>Baht</b> 1,200,000.00			

  
 นางสุดารัตน์ ไชยพันธุ์  
 ผู้อำนวยการฝ่ายวิศวกรรมระบบส่ง

31 Aug 2022

**MEDIUM COST FOR BID NO. RTS2-S-09**  
**1C1 : Foundation Work**  
**SUPPLY AND CONSTRUCTION OF 230 KV BHUMIBOL SUBSTATION (GIS)**  
**TRANSMISSION SYSTEM EXPANSION AND RENOVATION PROJECT PHASE 2**

Item No.	Description	Drawing No. / Reference No.	Qty.	Unit	Local Currency ( excluding VAT ) Baht	
					Unit Price	Amount
1C1-1	230 kV Take off Structure with Fire Wall Foundation (TS803)	Design by contractor, NCS-TS-8-03, See Dwg. No. BB-S-7 02/02, See Scope of work	3	set	649,527.00	1,948,581.00
1C1-2	Transformer Foundation (T-300) Pad Type	FD-TX-8-05 01/01	2	set	543,441.00	1,086,882.00
1C1-3	22&33 kV Distribution Transformer foundation (DX402) Pad Type	FD-DX-4-01 01/01	2	set	12,379.00	24,758.00
1C1-4	Outdoor marshalling Cubicle foundation and Sub-Trench (MC002) Pad Type	FD-MC-0-06 01/01	2	set	10,749.00	21,498.00
1C1-5	Junction Box Structure foundation (JB001) Pad Type	FD-JB-0-03 01/01	2	set	8,715.00	17,430.00

  
นางสุตารัตน์ ไชยพันธุ์  
ผู้อำนวยการฝ่ายวิศวกรรมระบบส่ง

31 Aug 2022

  
นางสาวอัสยา ช่างวิทยากร  
หจคตส-ท.  
21 ก.ย. 2565

**MEDIUM COST FOR BID NO. RTS2-S-09**  
**1C1 : Foundation Work**  
**SUPPLY AND CONSTRUCTION OF 230 KV BHUMIBOL SUBSTATION (GIS)**  
**TRANSMISSION SYSTEM EXPANSION AND RENOVATION PROJECT PHASE 2**

Item No.	Description	Drawing No. / Reference No.	Qty.	Unit	Local Currency ( excluding VAT ) Baht	
					Unit Price	Amount
1C1-6	Junction Box Structure foundation (JB003) Pad Type	FD-JB-0-05 01/01	2	set	7,531.00	15,062.00



นางสุดารัตน์ ไชยพันธุ์  
 ผู้อำนวยการฝ่ายวิศวกรรมระบบส่ง

31 Aug 2022



นางสาวอัสยา ช่างวิทยากา  
 ทจตส-ท.

21 ก.ย. 2565

**MEDIUM COST FOR BID NO. RTS2-S-09**  
**1C1 : Foundation Work**  
**SUPPLY AND CONSTRUCTION OF 230 KV BHUMIBOL SUBSTATION (GIS)**  
**TRANSMISSION SYSTEM EXPANSION AND RENOVATION PROJECT PHASE 2**

Item No.	Description	Drawing No. / Reference No.	Qty.	Unit	Local Currency ( excluding VAT ) Baht	
					Unit Price	Amount
1C1-7	Lighting Relay Panel foundation (RP002) Pad Type	FD-RP-0-03 01/01	1	set	7,221.00	7,221.00
1C1-8	30m Telecommunication Tower Foundation(WSA.)	Designed by Contractor, FD-TT-0-07 01/01, See Scope of work	1	set	143,230.00	143,230.00
1C1-9	Outdoor Load Break Switch foundation. (LBS)	Designed by Contractor, FD-DX-4-01 01/01, See Scope of work	2	set	12,379.00	24,758.00
1C1-10	115 kV Cable riser support structure foundation (TA702) Pad Type	Designed by Contractor, FD-TM-7-03 01/01, See Scope of work	4	set	26,818.00	107,272.00
<b>Total Price for Schedule 1C1</b>					<b>Baht 3,396,692.00</b>	

  
 นางสุตารัตน์ ไชยพันธุ์  
 ผู้อำนวยการฝ่ายวิศวกรรมระบบส่ง  
 31 Aug 2022

  
 นางสาวอวยสา ช่างวิทยากา  
 หจกส-ท.  
 21 ก.ย. 2565

นางสาวอัสยา ชาญวิทยากร  
 21 ก.ย. 2565

**MEDIUM COST FOR BID NO. RTS2-S-09**  
**1C2 : Cable Trench**  
**SUPPLY AND CONSTRUCTION OF 230 KV BHUMBOL SUBSTATION (GIS)**  
**TRANSMISSION SYSTEM EXPANSION AND RENOVATION PROJECT PHASE 2**

Item No.	Description	Drawing No. / Reference No.	Qty.	Unit	Local Currency (excluding VAT) Baht		
					Unit Price	Amount	
1C2-1	Standard cable trench, steel cover included (Type"A")	SD-CE-0-02 - 01/02, SD-CE-0-02 - 02/02		Lump Sum	Lump Sum	1,687,235.00	1,687,235.00
1C2-2	Standard cable trench, steel cover included (Type"B")	SD-CE-0-02 - 01/02, SD-CE-0-02 - 02/02		Lump Sum	Lump Sum	553,539.00	553,539.00
1C2-3	Cable trench type "A" including RC cover for XLPE system	Designed by Contractor		Lump Sum	Lump Sum	7,870,375.00	7,870,375.00
1C2-4	Cable trench type "B" including RC cover for XLPE system	Designed by Contractor		Lump Sum	Lump Sum	3,727,644.00	3,727,644.00
<b>Total Price for Schedule 1C2</b>						<b>Baht</b>	<b>13,838,793.00</b>

  
 นางสุตารัตน์ ไชยพันธุ์  
 ผู้อำนวยการฝ่ายวิศวกรรมระบบส่ง

31 Aug 2022

  
 นางสาวอาสยา ช่างวิทยากร  
 ทจตส-ท.  
 21 ก.ย. 2565

**MEDIUM COST FOR BID NO. RTS2-S-09**  
**1C3 : Building**  
**SUPPLY AND CONSTRUCTION OF 230 KV BHUMIBOL SUBSTATION (GIS)**  
**TRANSMISSION SYSTEM EXPANSION AND RENOVATION PROJECT PHASE 2**

Item No.	Description	Drawing No. / Reference No.	Qty.	Unit	Local Currency (excluding VAT) Baht	
					Unit Price	Amount
1C3-1	230/115 kV GIS Building	Designed by Contractor, BB-GIS-8-01A 01/14-14/14, See Scope of work	Lump Sum	Lump Sum	169,264,965.12	169,264,965.12
1C3-2.1	Air conditioning system and Ventilation system					
1C3-2.1.1	Minimum 30,000 BTU split-type air conditioner, including installation fee ( Not Higher than the price specified by the Bureau of the Budget www.bb.go.th )		1	set	38,785.05	38,785.05
1C3-2.1.2	Minimum 36,000 BTU split-type air conditioner, including installation fee ( Not Higher than the price specified by the Bureau of the Budget www.bb.go.th )		5	set	42,523.36	212,616.80
1C3-2.1.3	Minimum 40,000 BTU split-type air conditioner (Invertor), including installation fee ( Not Higher than the price specified by the Bureau of the Budget www.bb.go.th )		4	set	54,672.90	218,691.60

  
 นางสุดารัตน์ ไชยพันธุ์  
 ผู้อำนวยการฝ่ายวิศวกรรมระบบส่ง  
 31 Aug 2022



อดิศา ชื่นชื่นงาม  
 นางสาวอดิศา ชื่นชื่นงาม  
 วิศวกร  
 21 ก.ย. 2565

**MEDIUM COST FOR BID NO. RTS2-S-09**  
**1C3 : Building**  
**SUPPLY AND CONSTRUCTION OF 230 KV BHUMIBOL SUBSTATION (GIS)**  
**TRANSMISSION SYSTEM EXPANSION AND RENOVATION PROJECT PHASE 2**

Item No.	Description	Drawing No. / Reference No.	Qty.	Unit	Local Currency (excluding VAT) Baht	
					Unit Price	Amount
1C3-2.1.4	Minimum 48,000 BTU split-type air conditioner (Invertor), including installation fee ( Not Higher than the price specified by the Bureau of the Budget www.bb.go.th )		4	set	56,915.89	227,663.56
1C3-2.1.5	Minimum 60,000 BTU split-type air conditioner (Invertor), including installation fee ( Not Higher than the price specified by the Bureau of the Budget www.bb.go.th )		12	set	59,801.00	717,612.00
1C3-2.1.6	Extra work for air conditioning system (additional cooling capacity included)		Lump Sum	Lump Sum	Include in 1C3-1	Include in 1C3-1
1C3-2.1.7	Ventilation system		Lump Sum	Lump Sum	Include in 1C3-1	Include in 1C3-1
<b>Total Price for Schedule 1C3</b>					<b>Baht 170,680,334.13</b>	

  
 นางสุตารัตน์ ไชยพันธุ์  
 ผู้อำนวยการฝ่ายวิศวกรรมระบบส่ง

31 Aug 2022

**MEDIUM COST FOR BID NO. RTS2-S-09**  
**1C4 : Earth Work, Road and Crushed Rock Surfacing**  
**SUPPLY AND CONSTRUCTION OF 230 KV BHUMIBOL SUBSTATION (GIS)**  
**TRANSMISSION SYSTEM EXPANSION AND RENOVATION PROJECT PHASE 2**

Item No.	Description	Drawing No. / Reference No.	Qty.	Unit	Local Currency (excluding VAT) Baht		
					Unit Price	Amount	
1C4-1	Crushed rock surfacing 0.10 m thickness			Lump Sum	Lump Sum	498,000.00	498,000.00
1C4-2	RC.Road type " E " section 4 - 4	SD-RD-0-01 01/02 to 02/02		Lump Sum	Lump Sum	2,860,200.00	2,860,200.00
1C4-3	Transformer loading	SD-RD-0-03 01/01		Lump Sum	Lump Sum	66,960.00	66,960.00
1C4-4	Existing Rc.Road ( To be removed )			Lump Sum	Lump Sum	121,242.00	121,242.00
1C4-5	Embankment for site preparation			Lump Sum	Lump Sum	3,305,055.00	3,305,055.00



นางสุดารัตน์ ไชยพันธุ์  
ผู้อำนวยการฝ่ายวิศวกรรมระบบส่ง

31 Aug 2022

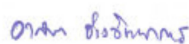

นางสาวอัสยา ช่างวิทยากา  
ทจตส-ท.

21 ก.ย. 2565

**MEDIUM COST FOR BID NO. RTS2-S-09**  
**1C4 : Earth Work, Road and Crushed Rock Surfacing**  
**SUPPLY AND CONSTRUCTION OF 230 KV BHUMIBOL SUBSTATION (GIS)**  
**TRANSMISSION SYSTEM EXPANSION AND RENOVATION PROJECT PHASE 2**

Item No.	Description	Drawing No. / Reference No.	Qty.	Unit	Local Currency (excluding VAT) Baht		
					Unit Price	Amount	
1C4-6	Stripping ≥0.30 m			Lump Sum	Lump Sum	359,822.00	359,822.00
<b>Total Price for Schedule 1C4</b>						<b>Baht</b>	<b>7,211,279.00</b>

  
 นางสุตารัตน์ ไชยพันธุ์  
 ผู้อำนวยการฝ่ายวิศวกรรมระบบส่ง  
 31 Aug 2022

  
 นางสาวอัสยา ช่างวิทยากา  
 หจตส-ท.  
 21 ก.ย. 2565

**MEDIUM COST FOR BID NO. RTS2-S-09**  
**1C5 : Water Supply System**  
**SUPPLY AND CONSTRUCTION OF 230 KV BHUMIBOL SUBSTATION (GIS)**  
**TRANSMISSION SYSTEM EXPANSION AND RENOVATION PROJECT PHASE 2**

Item No.	Description	Drawing No. / Reference No.	Qty.	Unit	Local Currency (excluding VAT) Baht		
					Unit Price	Amount	
1C5-1	Water supply system	Designed by Contractor, See Dwg. No. BB-C-9, See Scope of work		Lump Sum	Lump Sum	98,099.00	98,099.00
<b>Total Price for Schedule 1C5</b>					<b>Baht</b>		<b>98,099.00</b>



นางสุตารัตน์ ไชยพันธุ์  
ผู้อำนวยการฝ่ายวิศวกรรมระบบส่ง

31 Aug 2022



นางสาวอัสยา ช่างวิทยากา  
ทจตส.ท.

21 ก.ย. 2565

**MEDIUM COST FOR BID NO. RTS2-S-09**  
**1C6 : Drainage System**  
**SUPPLY AND CONSTRUCTION OF 230 KV BHUMIBOL SUBSTATION (GIS)**  
**TRANSMISSION SYSTEM EXPANSION AND RENOVATION PROJECT PHASE 2**

Item No.	Description	Drawing No. / Reference No.	Qty.	Unit	Local Currency (excluding VAT) Baht	
					Unit Price	Amount
1C6-1	Oil separator (Pad type)	SD-OS-0-02 01/03 to 03/03	1	set	1,187,421.00	1,187,421.00
1C6-2	Oil pit with steel grating	WD-DN-0-04 01/01	Lump Sum	Lump Sum	1,526,688.00	1,526,688.00
1C6-3	Drainage System	Designed by Contractor See Dwg. No. BB-C-6 See Scope of work	Lump Sum	Lump Sum	8,634,135.00	8,634,135.00
<b>Total Price for Schedule 1C6</b>					<b>Baht</b>	<b>11,348,244.00</b>

  
 นางสุตารัตน์ ไชยพันธุ์  
 ผู้อำนวยการฝ่ายวิศวกรรมระบบส่ง  
 31 Aug 2022

  
 นางสาวอาสยา ช่างวิทยากาฬ  
 วิศวศส-ท.  
 21 ก.ย. 2565

**MEDIUM COST FOR BID NO. RTS2-S-09**  
**1C7 : Special Construction Works**  
**SUPPLY AND CONSTRUCTION OF 230 KV BHUMIBOL SUBSTATION (GIS)**  
**TRANSMISSION SYSTEM EXPANSION AND RENOVATION PROJECT PHASE 2**

Item No.	Description	Drawing No. / Reference No.	Qty.	Unit	Local Currency ( excluding VAT ) Baht	
					Unit Price	Amount
1C7-1	64 sq.m Site office	See Scope of work	1	set	850,000.00	850,000.00
1C7-2	Architectural and Civil engineering design work		Lump Sum	Lump Sum	7,832,762.36	7,832,762.36
1C7-3	Plate bearing test		1	set	20,000.00	20,000.00
1C7-4	Dynamic Pile load test		Lump Sum	Lump Sum	120,000.00	120,000.00
1C7-5	Static pile load test		1	set	184,422.15	184,422.15
<b>Total Price for Schedule 1C7</b>					<b>Baht 9,007,184.51</b>	

  
 นางสาวสุตารัตน์ ไชยพันธุ์  
 ผู้อำนวยการฝ่ายวิศวกรรมระบบส่ง  
 31 Aug 2022

  
 นางสาวอาสยา ช่างวิทยากา  
 หจกตส-ท.  
 21 ก.ย. 2565

**MEDIUM COST FOR BID NO. RTS2-S-09**  
**1C8 : Miscellaneous**  
**SUPPLY AND CONSTRUCTION OF 230 KV BHUMIBOL SUBSTATION (GIS)**  
**TRANSMISSION SYSTEM EXPANSION AND RENOVATION PROJECT PHASE 2**

Item No.	Description	Drawing No. / Reference No.	Qty.	Unit	Local Currency (excluding VAT) Baht		
					Unit Price	Amount	
1C8-1	Concrete block with wire mesh fence (Pad type , Pile type)	SD-RF-0-01 01/01		Lump Sum		986,200.00	986,200.00
1C8-2	Concrete block with barbed wire fence (Pad type , Pile type)	SD-RF-0-02 01/01		Lump Sum		1,085,400.00	1,085,400.00
1C8-3	Main entrance gate 8.00m width (sliding)	SD-SG-0-03 01/01	2	set		440,044.00	880,088.00
1C8-4	Sign Board Structure & foundation	SD-SB-0-08 01/01	1	set		182,105.00	182,105.00
1C8-5	Standard symbol and sign letters of substation	TP655A-MS-A 01/01	1	set		664,993.00	664,993.00



นางสุตารัตน์ ไชยพันธุ์  
 ผู้อำนวยการฝ่ายวิศวกรรมระบบส่ง

31 Aug 2022



นางสาวอสาชา ช่างวิทยากร  
 ทจตส.ท.

21 ก.ย. 2565

นางสาวอาสยา ช่างวิทยากร  
 หจกส.พ.  
 21 ก.ย. 2565

**MEDIUM COST FOR BID NO. RTS2-S-09**  
**1C8 : Miscellaneous**  
**SUPPLY AND CONSTRUCTION OF 230 KV BHUMIBOL SUBSTATION (GIS)**  
**TRANSMISSION SYSTEM EXPANSION AND RENOVATION PROJECT PHASE 2**

Item No.	Description	Drawing No. / Reference No.	Qty.	Unit	Local Currency (excluding VAT) Baht	
					Unit Price	Amount
1C8-6	Guard house	HS-GH-0-02 01/05 to 05/05	1	set	455,261.00	455,261.00
1C8-7	Garage (5.50x6.00 m)	HS-PS-0-02 01/01	1	set	122,261.00	122,261.00
1C8-8	Flag Pole (15.00m)	SD-FP-0-02 01/01	1	set	236,362.00	236,362.00
1C8-9	Wire mesh fence (existing to be removed)		Lump Sum	Lump Sum	51,072.00	51,072.00
<b>Total Price for Schedule 1C8</b>					<b>Baht</b>	<b>4,663,742.00</b>



นางสุดารัตน์ ไชยพันธุ์  
 ผู้อำนวยการฝ่ายวิศวกรรมระบบส่ง

31 Aug 2022



  
 นางสาวอาสยา ช่างวิทยากา  
 หจกต-ท.  
 21 ก.ย. 2565

**MEDIUM COST FOR BID NO. RTS2-S-09**  
**1D7 : Spare Parts for SF6 Gas Insulated Switchgear**  
**SUPPLY AND CONSTRUCTION OF 230 KV BHUMIBOL SUBSTATION (GIS)**  
**TRANSMISSION SYSTEM EXPANSION AND RENOVATION PROJECT PHASE 2**

Item No.	Description	Qty.	Unit	Currency	Supply of Equipment				Local Transportation	
					Foreign Supply		Local Supply		( excluding VAT ) Baht	
					CIF Thai Port		Ex-works Price ( excluding VAT ) Baht			
					Unit Price	Amount	Unit Price	Amount	Unit Price	Amount
1D7-1	Gas density meter with two-stage contacts for circuit breaker compartment spare parts for GIS	1	set	THB	23,950.00	23,950.00			XXXXX	XXXXX
1D7-2	Gas density meter for other compartment spare parts for GIS	1	set	THB	48,752.00	48,752.00			XXXXX	XXXXX
1D7-3	Rupture disc of overpressure protection device spare parts for GIS (1EA for each type/each operating pressure)	1	set	THB	23,959.00	23,959.00			XXXXX	XXXXX
1D7-4	Pump with motor for hydraulic spare parts for GIS (if any)	1	set	THB	included	included			XXXXX	XXXXX
1D7-5	Maintenance closing device for circuit breaker	1	set	THB	33,659.00	33,659.00			XXXXX	XXXXX
1D7-6	SF6 gas filling cart accessories for GIS	1	set	THB	325,532.00	325,532.00			XXXXX	XXXXX
1D7-7	Operating Analyzer Fitting Means accessories for GIS	1	set	THB	232,988.00	232,988.00			XXXXX	XXXXX
1D7-8	Hand pump for hydraulic accessories for GIS (if any)	1	set	THB	included	included			XXXXX	XXXXX
1D7-9	Cost of Local Transportation for Item No. 1D7-1 thru 1D7-8			THB	XXXXX	XXXXX	XXXXX	XXXXX	51,663.00	51,663.00
				<b>THB</b>	<b>688,840.00</b>		<b>Baht</b>		<b>Baht</b>	
									<b>51,663.00</b>	
 <b>Total Price for Schedule 1D7</b>										

นางสุตารัตน์ ไชยพันธุ์  
 ผู้อำนวยการฝ่ายวิศวกรรมระบบส่ง

31 Aug 2022

**MEDIUM COST FOR BID NO. RTS2-S-09**  
**1D11 : Spare Parts for Power Fuse, Fuse Link and Hook Stick**  
**SUPPLY AND CONSTRUCTION OF 230 KV BHUMIBOL SUBSTATION (GIS)**  
**TRANSMISSION SYSTEM EXPANSION AND RENOVATION PROJECT PHASE 2**

Item No.	Description	Qty.	Unit	Currency	Supply of Equipment				Local Transportation	
					Foreign Supply		Local Supply		( excluding VAT ) Baht	
					CIF Thai Port		Ex-works Price ( excluding VAT ) Baht			
					Unit Price	Amount	Unit Price	Amount	Unit Price	Amount
1D11-1	Fuse link or refill unit 20E for 22 kV power fuse (standard speed)	6		THB	12,764.40	76,586.40			XXXXX	XXXXX
1D11-2	Cost of Local Transportation for Item No. 1D11-1		Lump sum		XXXXX	XXXXX	XXXXX	XXXXX	5,743.98	5,743.98
<b>Total Price for Schedule 1D11</b>				THB	<b>76,586.40</b>		Baht		<b>Baht 5,743.98</b>	

  
นางสุตารัตน์ ไชยพันธุ์  
ผู้อำนวยการฝ่ายวิศวกรรมระบบส่ง

31 Aug 2022

  
นางสาวอาสยา ช่างวิทยากา  
หจตส-ท.  
21 ก.ย. 2565

**MEDIUM COST FOR BID NO. RTS2-S-09**  
**1D12 : Spare Parts for AC&DC Distribution Board and Termination Box**  
**SUPPLY AND CONSTRUCTION OF 230 KV BHUMIBOL SUBSTATION (GIS)**  
**TRANSMISSION SYSTEM EXPANSION AND RENOVATION PROJECT PHASE 2**

Item No.	Description	Qty.	Unit	Currency	Supply of Equipment				Local Transportation (excluding VAT) Baht	
					Foreign Supply		Local Supply			
					CIF Thai Port		Ex-works Price (excluding VAT) Baht			
					Unit Price	Amount	Unit Price	Amount	Unit Price	Amount
1D12-1	Fuse time lag type 800 A	6					20,538.00	123,228.00	XXXXX	XXXXX
1D12-2	Cost of Local Transportation for Item No. 1D12-1	Lump sum	Lump sum		XXXXX	XXXXX	XXXXX	XXXXX	9,242.10	9,242.10
<b>Total Price for Schedule 1D12</b>							<b>Baht</b> 123,228.00		<b>Baht</b> 9,242.10	



นางสุตารัตน์ ไชยพันธุ์  
 ผู้อำนวยการฝ่ายวิศวกรรมระบบส่ง

31 Aug 2022



นางสาวอาสยา ช่างวิทยากา  
 หจกส-ท.

21 ก.ย. 2565

ดร. ชัยวัฒน์  
นางสาวอาศยา ช่างวิทยากร  
หงตส-ท.  
21 ก.ย. 2565

**MEDIUM COST FOR BID NO. RTS2-S-09**  
**1D24 : Spare Parts for Control and Protection System**  
**SUPPLY AND CONSTRUCTION OF 230 KV BHUMIBOL SUBSTATION (GIS)**  
**TRANSMISSION SYSTEM EXPANSION AND RENOVATION PROJECT PHASE 2**

Item No.	Description	Drawing No. / Reference No.	Qty.	Unit	Currency	Supply of Equipment				Local Transportation	
						Foreign Supply		Local Supply		Local Transportation ( excluding VAT ) Baht	
						CIF Thai Port		Ex-works Price ( excluding VAT ) Baht			
						Unit Price	Amount	Unit Price	Amount	Unit Price	Amount
1D24-1	Multi-function Protective IED (87B, 95B)	Supply as Spare Part Same Model Type as Supplied in Item 1AB24-1 (Primary Protection) Specification No. 1008	1	Ea				1,087,500	1,087,500.00	54,375	54,375.00
1D24-2	Multi-function Protective IED (87B, 95B)	Supply as Spare Part Same Model Type as Supplied in Item 1AB24-1 (Secondary Protection) Specification No. 1008	1	Ea				1,087,500	1,087,500.00	54,375	54,375.00
1D24-3	Multi-function Protective IED (87L, 21BU, 67N, 50BF, 79, 25, 51S/51SG)	Supply as Spare Part Same Model Type as Supplied in Item 1AB24- 2 and 1AB24-3 (Primary Protection) Specification No. 1008	1	Ea				749,165	749,165.00	37,458	37,458.00



นางสุตารัตน์ ไชยพันธุ์  
ผู้อำนวยการฝ่ายวิศวกรรมระบบส่ง

31 Aug 2022

**MEDIUM COST FOR BID NO. RTS2-S-09**  
**1D24 : Spare Parts for Control and Protection System**  
**SUPPLY AND CONSTRUCTION OF 230 KV BHUMIBOL SUBSTATION (GIS)**  
**TRANSMISSION SYSTEM EXPANSION AND RENOVATION PROJECT PHASE 2**

Item No.	Description	Drawing No. / Reference No.	Qty.	Unit	Currency	Supply of Equipment				Local Transportation (excluding VAT) Baht			
						Foreign Supply		Local Supply					
						CIF Thai Port		Ex-works Price (excluding VAT) Baht		Unit Price	Amount	Unit Price	Amount
						Unit Price	Amount	Unit Price	Amount				
1D24-4	Multi-function Protective IED (87L, 21BU, 67N, 50BF, 79, 25, 51S/51SG)	Supply as Spare Part Same Model Type as Supplied in Item 1AB24-2 (Secondary Protection) Specification No. 1008	1	Ea				749,165	749,165.00	37,458	37,458.00		
1D24-5	Multi-function Protective IED (21P, 67N, 50BF, 79, 25, 51S/51SG)	Supply as Spare Part Same Model Type as Supplied in Item 1AB24-2 and 1AB24-3 (Secondary Protection) Specification No. 1008	1	Ea				539,255	539,255.00	26,962	26,962.00		
1D24-6	Multi-function Protective IED (87K-5 RES, 51T/51TG, 50BF, 59)	Supply as Spare Part Same Model Type as Supplied in Item 1AB24-4 (Primary Protection) Specification No. 1008	1	Ea				553,415	553,415.00	27,670	27,670.00		

  
 นางสุดารัตน์ ไชยพันธุ์  
 ผู้อำนวยการฝ่ายวิศวกรรมระบบส่ง

31 Aug 2022

  
 นางสาวอัสยา ช่างวิทยากา  
 หจตส-ท.  
 21 ก.ย. 2565

อรุณ ชื่นจันทร์  
นางสาวอาสยา ชาญวิทยากาน  
หงตส-ท.  
21 ก.ย. 2565

**MEDIUM COST FOR BID NO. RTS2-S-09**  
**1D24 : Spare Parts for Control and Protection System**  
**SUPPLY AND CONSTRUCTION OF 230 KV BHUMIBOL SUBSTATION (GIS)**  
**TRANSMISSION SYSTEM EXPANSION AND RENOVATION PROJECT PHASE 2**

Item No.	Description	Drawing No. / Reference No.	Qty.	Unit	Currency	Supply of Equipment				Local Transportation ( excluding VAT ) Baht			
						Foreign Supply		Local Supply					
						CIF Thai Port		Ex-works Price ( excluding VAT ) Baht		Unit Price	Amount	Unit Price	Amount
						Unit Price	Amount	Unit Price	Amount				
1D24-7	Multi-function Protective IED (87K-5 RES, 51T/51TG, 50BF, 59)	Supply as Spare Part Same Model Type as Supplied in Item 1AB24-4 (Secondary Protection) Specification No. 1008	1	Ea				553,415	553,415.00	27,670	27,670.00		
1D24-8	Multi-function Protective IED (51/51G, 81, 27, 59)	Supply as Spare Part Same Model Type as Supplied in Item 1AB24-4 (Feeder Protection) Specification No. 1008	1	Ea				350,415	350,415.00	17,520	17,520.00		
1D24-9	Multi-function Protective IED (87B, 95B)	Supply as Spare Part Same Model Type as Supplied in Item 2AB24-1 (Primary Protection) Specification No. 1008	1	Ea				1,087,500	1,087,500.00	54,375	54,375.00		
1D24-10	Multi-function Protective IED (87B, 95B)	Supply as Spare Part Same Model Type as Supplied in Item 2AB24-1 (Secondary Protection) Specification No. 1008	1	Ea				1,087,500	1,087,500.00	54,375	54,375.00		



นางสุตารัตน์ ไชยพันธุ์  
ผู้อำนวยการฝ่ายวิศวกรรมระบบส่ง

31 Aug 2022

นางสาวอาสยา ช่างวิทยากา  
 หจกตส-ท.  
 21 ก.ย. 2565

**MEDIUM COST FOR BID NO. RTS2-S-09**  
**1D24 : Spare Parts for Control and Protection System**  
**SUPPLY AND CONSTRUCTION OF 230 KV BHUMIBOL SUBSTATION (GIS)**  
**TRANSMISSION SYSTEM EXPANSION AND RENOVATION PROJECT PHASE 2**

Item No.	Description	Drawing No. / Reference No.	Qty.	Unit	Currency	Supply of Equipment				Local Transportation	
						Foreign Supply		Local Supply		( excluding VAT ) Baht	
						CIF Thai Port		Ex-works Price			
						Unit Price	Amount	Unit Price	Amount	Unit Price	Amount
1D24-11	Multi-function Protective IED (87L, 21BU, 67N, 50BF, 79, 25, 51S/51SG)	Supply as Spare Part Same Model Type as Supplied in Item 2AB24-2 (Primary Protection) Specification No. 1008	1	Ea				749,165	749,165.00	37,458	37,458.00
1D24-12	Multi-function Protective IED (87L, 21BU, 67N, 50BF, 79, 25, 51S/51SG)	Supply as Spare Part Same Model Type as Supplied in Item 2AB24-2 (Secondary Protection) Specification No. 1008	1	Ea				749,165	749,165.00	37,458	37,458.00
1D24-13	Multi-function Protective IED (21P, 67N, 50BF, 79, 25, 51S/51SG)	Supply as Spare Part Same Model Type as Supplied in Item 2AB24-2 (Primary Protection) Specification No. 1008	1	Ea				539,255	539,255.00	26,962	26,962.00
1D24-14	Multi-function Protective IED (21P, 67N, 50BF, 79, 25, 51S/51SG)	Supply as Spare Part Same Model Type as Supplied in Item 2AB24-2 (Secondary Protection) Specification No. 1008	1	Ea				539,255	539,255.00	26,962	26,962.00

นางสุดารัตน์ ไชยพันธ์  
 ผู้อำนวยการฝ่ายวิศวกรรมระบบส่ง  
 31 Aug 2022

  
 นางสาวอาสยา ช่างวิทยากษ  
 ทจตส.ท.  
 21 ก.ย. 2565

**MEDIUM COST FOR BID NO. RTS2-S-09**  
**1D24 : Spare Parts for Control and Protection System**  
**SUPPLY AND CONSTRUCTION OF 230 KV BHUMIBOL SUBSTATION (GIS)**  
**TRANSMISSION SYSTEM EXPANSION AND RENOVATION PROJECT PHASE 2**

Item No.	Description	Drawing No. / Reference No.	Qty.	Unit	Currency	Supply of Equipment				Local Transportation ( excluding VAT ) Baht			
						Foreign Supply		Local Supply					
						CIF Thai Port		Ex-works Price ( excluding VAT ) Baht		Unit Price	Amount	Unit Price	Amount
						Unit Price	Amount	Unit Price	Amount				
1D24-15	Multi-function Protective IED (87K-5 RES, 51T/51TG, 50BF, 59)	Supply as Spare Part Same Model Type as Supplied in Item 2AB24-3 (Primary Protection) Specification No. 1008	1	Ea				553,415	553,415.00	27,670	27,670.00		
1D24-16	Multi-function Protective IED (87K-5 RES, 51T/51TG, 50BF, 59)	Supply as Spare Part Same Model Type as Supplied in Item 2AB24-3 (Secondary Protection) Specification No. 1008	1	Ea				553,415	553,415.00	27,670	27,670.00		
1D24-17	Multi-function Protective IED (51/51G, 81, 27, 59)	Supply as Spare Part Same Model Type as Supplied in Item 2AB24-3 (Feeder Protection) Specification No. 1008	1	Ea				350,415	350,415.00	17,520	17,520.00		
1D24-18	DIGITAL SUBSTATION SYSTEM -- Energy Meter 	Supply as Spare Part Same Model Type as Supplied in Item 1AB24-19 and 2AB24-5 Specification No. 1008	1	Ea				630,170	630,170.00	31,508	31,508.00		

นางสุดารัตน์ ไชยพันธุ์  
ผู้อำนวยการฝ่ายวิศวกรรมระบบส่ง

31 Aug 2022

- Project 1-1C5 -

filename : RTS2-S-09-1 (230 kV BB)



**MEDIUM COST FOR BID NO. RTS2-S-09**  
**1D24 : Spare Parts for Control and Protection System**  
**SUPPLY AND CONSTRUCTION OF 230 KV BHUMIBOL SUBSTATION (GIS)**  
**TRANSMISSION SYSTEM EXPANSION AND RENOVATION PROJECT PHASE 2**

Item No.	Description	Drawing No. / Reference No.	Qty.	Unit	Currency	Supply of Equipment				Local Transportation ( excluding VAT ) Baht			
						Foreign Supply		Local Supply					
						CIF Thai Port		Ex-works Price ( excluding VAT ) Baht		Unit Price	Amount	Unit Price	Amount
						Unit Price	Amount	Unit Price	Amount				
1D24-19	DIGITAL SUBSTATION SYSTEM -- Bay Control Unit	Supply as Spare Part Same Model Type as Supplied in Item 1AB24-5, 1AB24-6 and 2AB24-4 Specification No. 1008	1	Ea				464,482	464,482.00	23,224	23,224.00		
1D24-20	DIGITAL SUBSTATION SYSTEM -- Ethernet Switch	Supply as Spare Part Same Model Type as Supplied in Item 1AB24-10 to 1AB24-12 Specification No. 1008	1	Ea				444,665	444,665.00	22,233	22,233.00		
1D24-21	DIGITAL SUBSTATION SYSTEM -- MERGING UNIT SET (1-CT(3ph), 1- VT(3ph), 8-BI, 8-BO)	Supply as Spare Part Specification No. 1008	1	Ea				539,365	539,365.00	26,968	26,968.00		
<b>Total Price for Schedule 1D24</b>								<b>Baht</b> 13,957,597.00		<b>Baht</b> 697,871.00			



นางสุตารัตน์ ไชยพันธุ์  
ผู้อำนวยการฝ่ายวิศวกรรมระบบส่ง

31 Aug 2022

นางสาวอัสยา ช่างวิทยากร  
พจตส-ท.

21 ก.ย. 2565

นางสาวอภิสรา ช่างวิทยากาน  
 21 ก.ย. 2565

**MEDIUM COST FOR BID NO. RTS2-S-09**  
**1D25 : Spare Parts for Fault Recording System**  
**SUPPLY AND CONSTRUCTION OF 230 KV BHUMIBOL SUBSTATION (GIS)**  
**TRANSMISSION SYSTEM EXPANSION AND RENOVATION PROJECT PHASE 2**

Item No.	Description	Drawing No. / Reference No.	Qty.	Unit	Currency	Supply of Equipment				Local Transportation	
						Foreign Supply		Local Supply		( excluding VAT ) Baht	
						CIF Thai Port		Ex-works Price			
						Unit Price	Amount	Unit Price	Amount	Unit Price	Amount
1D25-1	POWER SUPPLY	Supply as Spare Part Specification Nos. 1003 and 1008	1	Ea			36,118	36,118.00	1,805	1,805.00	
1D25-2	ACQUISITION UNIT	Supply as Spare Part Specification Nos. 1003 and 1008	1	Ea			25,669	25,669.00	1,283	1,283.00	
1D25-3	CPU & MEMORY MODULE 1	Supply as Spare Part Specification Nos. 1003 and 1008	1	Ea			85,581	85,581.00	4,279	4,279.00	
1D25-4	DIGITAL ISOLATOR MODULE	Supply as Spare Part Specification Nos. 1003 and 1008	1	Ea			83,232	83,232.00	4,161	4,161.00	
1D25-5	HARD DISK & HARD DISK CONTROLLER	Supply as Spare Part Specification Nos. 1003 and 1008	1	Ea			77,022	77,022.00	3,851	3,851.00	
1D25-6	TELE- COMMUNICATION BOARD	Supply as Spare Part Specification Nos. 1003 and 1008	1	Ea			25,669	25,669.00	1,283	1,283.00	

นางสุดารัตน์ ไชยพันธุ์  
 ผู้อำนวยการฝ่ายวิศวกรรมระบบส่ง

31 Aug 2022

**MEDIUM COST FOR BID NO. RTS2-S-09**  
**1D25 : Spare Parts for Fault Recording System**  
**SUPPLY AND CONSTRUCTION OF 230 KV BHUMIBOL SUBSTATION (GIS)**  
**TRANSMISSION SYSTEM EXPANSION AND RENOVATION PROJECT PHASE 2**

Item No.	Description	Drawing No. / Reference No.	Qty.	Unit	Currency	Supply of Equipment				Local Transportation	
						Foreign Supply		Local Supply			
						CIF Thai Port		Ex-works Price (excluding VAT)		(excluding VAT) Baht	
						Unit Price	Amount	Unit Price	Amount		
<b>Total Price for Schedule 1D25</b>								<b>Baht</b>	<b>333,291.00</b>	<b>Baht</b>	<b>16,662.00</b>

  
 นางสุตารัตน์ ไชยพันธุ์  
 ผู้อำนวยการฝ่ายวิศวกรรมระบบส่ง  
 31 Aug 2022

  
 นางสาวอัสยา ช่างวิทยากา  
 หจตส-ท.  
 21 ก.ย. 2565

นางสาวอภิสยา ช่างวิทยากา  
 21 ก.ย. 2565

**MEDIUM COST FOR BID NO. RTS2-S-09**  
**1E24 : Control and Protection System**  
**SUPPLY AND CONSTRUCTION OF 230 KV BHUMIBOL SUBSTATION (GIS)**  
**TRANSMISSION SYSTEM EXPANSION AND RENOVATION PROJECT PHASE 2**

Item No.	Description	Drawing No. / Reference No.	Qty.	Unit	Currency	Supply of Equipment				Local Transportation		
						Foreign Supply		Local Supply		( excluding VAT ) Baht		
						CIF Thai Port		Ex-works Price				
						Unit Price	Amount	Unit Price	Amount	Unit Price	Amount	
1E24-1	Multi-function Protective IED (87L, 21BU, 67N, 50BF, 79, 25, 51S/51SG)	Supply as Loose Part for Installation at TA2 Substation - IED must be compatible with both Copper Wire (Having Binary Input, Binary Output and Analog Input) and IEC61850 Standard (4 Ports Ethernet for PRP) - Secondary Current Input Rating : 5A - Same Model Type as Supplied in Item 1AB24-3 (Primary Protection) - Have same connector type with Item No. 1E24-3 Specification Nos. 1002 and 1008	1	Ea					749,165	749,165.00	37,458	37,458.00

นางสุดารัตน์ ไชยพันธุ์  
 ผู้อำนวยการฝ่ายวิศวกรรมระบบส่ง  
 31 Aug 2022

อนัน ชื่นจันทร์

นางสาวอาสยา ช่างวิทยากท

ทจตส-ท.

21 ก.ย. 2565

**MEDIUM COST FOR BID NO. RTS2-S-09**  
**1E24 : Control and Protection System**  
**SUPPLY AND CONSTRUCTION OF 230 KV BHUMIBOL SUBSTATION (GIS)**  
**TRANSMISSION SYSTEM EXPANSION AND RENOVATION PROJECT PHASE 2**

Item No.	Description	Drawing No. / Reference No.	Qty.	Unit	Currency	Supply of Equipment				Local Transportation		
						Foreign Supply		Local Supply		Local Transportation ( excluding VAT ) Baht		
						CIF Thai Port		Ex-works Price ( excluding VAT ) Baht				
						Unit Price	Amount	Unit Price	Amount	Unit Price	Amount	
1E24-2	Multi-function Protective IED (87L, 21BU, 67N, 50BF, 79, 25, 51S/51SG)	Supply as Loose Part for Installation at BB Floating Solar Substation - IED must be compatible with both Copper Wire (Having Binary Input, Binary Output and Analog Input) and IEC61850 Standard (4 Ports Ethernet for PRP) - Have same connector type with Item No. 1E24-3 - Secondary Current Input Rating : 1A or 5A - Same Model Type as Supplied in Item 1AB24-3 (Primary Protection) - Have same connector type with Item No. 1E24-3 Specification Nos. 1002 and 1008	2	Ea					749,165	1,498,330.00	37,458	74,916.00

นางสุดารัตน์ ไชยพันธุ์

ผู้อำนวยการฝ่ายวิศวกรรมระบบส่ง

นางสาวอานิสยา ช่างวิทยากษ  
 วิศวกร  
 21 ก.ย. 2565

**MEDIUM COST FOR BID NO. RTS2-S-09**  
**1E24 : Control and Protection System**  
**SUPPLY AND CONSTRUCTION OF 230 KV BHUMIBOL SUBSTATION (GIS)**  
**TRANSMISSION SYSTEM EXPANSION AND RENOVATION PROJECT PHASE 2**

Item No.	Description	Drawing No. / Reference No.	Qty.	Unit	Currency	Supply of Equipment				Local Transportation			
						Foreign Supply		Local Supply		( excluding VAT ) Baht		( excluding VAT ) Baht	
						CIF Thai Port		Ex-works Price					
						Unit Price	Amount	Unit Price	Amount	Unit Price	Amount		
1E24-3	E1 CONVERTER	Supply for item 1E24-1 and 1E24-2 - This item include 2 sets of communication cable (for each E1) consists of 1 set of 30 m. multimode optic fiber patch cord cable and 1 set of 10 m. coaxial cable. - Have same connector type with Item No. 1E24-1 and 1E24-2 Specification No. SD-FOT-P22 Drawing No. TP-E-10.20	3	Ea					159,028	477,084.00	7,951	23,853.00	
<b>Total Price for Schedule 1E24</b>									<b>Baht 2,724,579.00</b>		<b>Baht 136,227.00</b>		



นางสุดารัตน์ ไชยพันธุ์  
 ผู้อำนวยการฝ่ายวิศวกรรมระบบส่ง

31 Aug 2022

**MEDIUM COST FOR BID NO. RTS2-S-09**  
**2AB1 : Power Transformer and Marshalling Control Cubicle**  
**SUPPLY AND CONSTRUCTION OF 115 KV BHUMIBOL SUBSTATION (GIS)**  
**TRANSMISSION SYSTEM EXPANSION AND RENOVATION PROJECT PHASE 2**

Item No.	Description	Qty.	Unit	Currency	Supply of Equipment				Local Transportation, Construction and (excluding VAT) Baht			
					Foreign Supply		Local Supply		Ex-works Price (excluding VAT) Baht			
					CIF Thai Port							
					Unit Price	Amount	Unit Price	Amount	Unit Price	Amount		
2AB1-1	Marshalling Control Cubicle as per EGAT's Dwg No. TP-E-10.5, TP-E-10.6 and TP-E-10.8	2		THB			110,000.00	220,000.00	XXXXX	XXXXX		
2AB1-2	Cost of Local Transportation, Construction and Installation for Item No. 2AB1-1	Lump sum	Lump sum		XXXXXX	XXXXXX	XXXXXX	XXXXXX	33,000.00	33,000.00		
<b>Total Price for Schedule 2AB1</b>				THB			<b>Baht 220,000.00</b>		<b>Baht 33,000.00</b>			

  
 นางสุตารัตน์ ไชยพันธุ์  
 ผู้อำนวยการฝ่ายวิศวกรรมระบบส่ง  
 31 Aug 2022

  
 นางสาวอาสยา ช่างวิทยากร  
 หจกส-ท.  
 21 ก.ย. 2565

นางสาวอาศยา ช่างวิทยากา  
 ภาควิศวกรรม  
 21 ก.ย. 2565

**MEDIUM COST FOR BID NO. RTS2-S-09**  
**2AB4 : Surge Arrester**  
**SUPPLY AND CONSTRUCTION OF 115 KV BHUMIBOL SUBSTATION (GIS)**  
**TRANSMISSION SYSTEM EXPANSION AND RENOVATION PROJECT PHASE 2**

Item No.	Description	Qty.	Unit	Currency	Supply of Equipment				Local Transportation, Construction and (excluding VAT) Baht			
					Foreign Supply		Local Supply		Ex-works Price (excluding VAT) Baht			
					CIF Thai Port							
					Unit Price	Amount	Unit Price	Amount	Unit Price	Amount		
2AB4-1	108 kV Surge Arrester as per Ratings and Features RF SA7Y01	9		THB	114,000.00	1,026,000.00			XXXXX	XXXXX		
2AB4-2	21 kV surge arrester as per ratings and features RF SA2Y11	12		THB	83,000.00	996,000.00			XXXXX	XXXXX		
2AB4-3	Steel Supporting Structure for SA7Y01 ( for Item No. 2AB4-1 ), H=4.50 m as per Dwg. No. ST-LA-7-01 and SD-AB-0-01	9		THB			55,000.00	495,000.00	XXXXX	XXXXX		
2AB4-4	Cost of Local Transportation, Construction and Installation for Item No 2AB4-1 thru 2AB4-3		Lump sum		XXXXXX	XXXXXX	XXXXXX	XXXXXX	377,550.00	377,550.00		
<b>Total Price for Schedule 2AB4</b>				THB	<b>2,022,000.00</b>		<b>Baht 495,000.00</b>		<b>Baht 377,550.00</b>			

นางสุดารัตน์ ไชยพันธุ์  
 ผู้อำนวยการฝ่ายวิศวกรรมระบบส่ง

31 Aug 2022



**MEDIUM COST FOR BID NO. RTS2-S-09**  
**2AB6 : Coupling Capacitor Voltage Transformer, Coupling Capacitor, Voltage Transformer and Junction Box**  
**SUPPLY AND CONSTRUCTION OF 115 KV BHUMIBOL SUBSTATION (GIS)**  
**TRANSMISSION SYSTEM EXPANSION AND RENOVATION PROJECT PHASE 2**

Item No.	Description	Qty.	Unit	Currency	Supply of Equipment				Local Transportation, Construction and (excluding VAT) Baht				
					Foreign Supply		Local Supply		Ex-works Price (excluding VAT) Baht				
					CIF Thai Port								
					Unit Price	Amount	Unit Price	Amount	Unit Price	Amount			
2AB6-1	115 kV CCVT, 550 kV BIL, 69000:119.5/69 & 119.5/69 V with carrier accessories, oil filled as per Ratings and Features RF PD7W0J	9		THB	223,000.00	2,007,000.00			XXXXXX	XXXXXX			
2AB6-2	Steel Supporting Structure for PD7W0J ( for Item No. 2AB6-1 ), H=4.50 m as per Dwg. No. ST-VT-4-01 and SD-AB-0-01	9		THB			24,000.00	216,000.00	XXXXXX	XXXXXX			
2AB6-3	Junction Box type PT11 ( for Item No. 2AB6-1 ) as per Dwg. No. TP-E-18.1-2/4, 3/4 and TP-E-18.4	3		THB			62,000.00	186,000.00	XXXXXX	XXXXXX			
2AB6-4	Cost of Local Transportation, Construction and Installation for Item No 2AB6-1 thru 2AB6-3	Lump sum	Lump sum		XXXXXX	XXXXXX	XXXXXX	XXXXXX	361,350.00	361,350.00			
<b>Total Price for Schedule 2AB6</b>				THB	<b>2,007,000.00</b>		Baht		<b>402,000.00</b>		Baht	<b>361,350.00</b>	

นางสุดารัตน์ ไชยพันธุ์  
 ผู้อำนวยการฝ่ายวิศวกรรมระบบส่ง

31 Aug 2022

  
 นางสาวอาสยา ช่างวิทยากุล  
 ทจตส-ท.  
 21 ก.ย. 2565

**MEDIUM COST FOR BID NO. RTS2-S-09**  
**2AB7 : SF6 Gas Insulated Switchgear**  
**SUPPLY AND CONSTRUCTION OF 115 KV BHUMIBOL SUBSTATION (GIS)**  
**TRANSMISSION SYSTEM EXPANSION AND RENOVATION PROJECT PHASE 2**

Item No.	Description	Qty.	Unit	Currency	Supply of Equipment				Local Transportation, Construction and Installation (excluding VAT) Baht			
					Foreign Supply		Local Supply		Unit Price	Amount	Unit Price	Amount
					CIF Thai Port		Ex-works Price (excluding VAT) Baht					
					Unit Price	Amount	Unit Price	Amount	Unit Price	Amount		
2AB7-1	123 kV 2000 A 40 kA Gas Insulated Switchgear as per Ratings and Features RF IS7541(IEC) and DWG. No. BB-S-1-03/04 and BB-S-2-01/01 (Line No.2 to Thoen)	1		THB	19,302,485.00	19,302,485.00			XXXXX	XXXXX		
2AB7-2	123 kV 2000 A 40 kA Gas Insulated Switchgear as per Ratings and Features RF IS7541(IEC) and DWG. No. BB-S-1-03/04 and BB-S-2-01/01 (KT1A)	1		THB	19,308,485.00	19,308,485.00			XXXXX	XXXXX		
2AB7-3	123 kV 2000 A 40 kA Gas Insulated Switchgear as per Ratings and Features RF IS7541(IEC) and DWG. No. BB-S-1-03/04 and BB-S-2-01/01 (Line No.1 to Thoen)	1		THB	19,308,485.00	19,308,485.00			XXXXX	XXXXX		
2AB7-4	123 kV 2000 A 40 kA Gas Insulated Switchgear as per Ratings and Features RF IS7541(IEC) and DWG. No. BB-S-1-03/04 and BB-S-2-01/01 (Line to Tak 1)	1		THB	19,308,485.00	19,308,485.00			XXXXX	XXXXX		
2AB7-5	123 kV 2000 A 40 kA Gas Insulated Switchgear as per Ratings and Features RF IS7541(IEC) and DWG. No. BB-S-1-03/04 and BB-S-2-01/01 (KT2A)	1		THB	19,308,485.00	19,308,485.00			XXXXX	XXXXX		
2AB7-6	123 kV 2000 A 40 kA Gas Insulated Switchgear as per Ratings and Features RF IS7541(IEC) and DWG. No. BB-S-1-03/04 and BB-S-2-01/01 (KT4A)	1		THB	19,308,485.00	19,308,485.00			XXXXX	XXXXX		
2AB7-7	123 kV 2000 A 40 kA Gas Insulated Switchgear as per Ratings and Features RF IS7541(IEC) and DWG. No. BB-S-1-03/04 and BB-S-2-01/01 (KT3A)	1		THB	19,308,485.00	19,308,485.00			XXXXX	XXXXX		

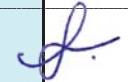
  
 นางสุดารัตน์ ไชยพันธุ์  
 ผู้อำนวยการฝ่ายวิศวกรรมระบบส่ง

31 Aug 2022

01/08/2022  
 นางสาวอาสยา ช่างวิทยากา  
 หจกส.ท.  
 21 ก.ย. 2565

**MEDIUM COST FOR BID NO. RTS2-S-09**  
**2AB7 : SF6 Gas Insulated Switchgear**  
**SUPPLY AND CONSTRUCTION OF 115 KV BHUMIBOL SUBSTATION (GIS)**  
**TRANSMISSION SYSTEM EXPANSION AND RENOVATION PROJECT PHASE 2**

Item No.	Description	Qty.	Unit	Currency	Supply of Equipment				Local Transportation, Construction and Installation (excluding VAT) Baht			
					Foreign Supply		Local Supply		Unit Price	Amount	Unit Price	Amount
					CIF Thai Port		Ex-works Price (excluding VAT) Baht					
					Unit Price	Amount	Unit Price	Amount	Unit Price	Amount		
2AB7-8	123 kV 2000 A 40 kA Gas Insulated Switchgear as per Ratings and Features RF IS7541(IEC)and DWG. No. BB-S-1-03/04 and BB-S-2-01/01 (Coupling bay)	1		THB	19,308,485.00	19,308,485.00			XXXXX	XXXXX		
2AB7-9	123 kV 2000 A 40 kA Gas Insulated Switchgear as per Ratings and Features RF IS7541(IEC)and DWG. No. BB-S-1-03/04 and BB-S-2-01/01 (Metal Enclosed Bus) including VTs and fast-acting earthing switches at main bus	lot		THB	included	included			XXXXX	XXXXX		
2AB7-10	123 kV 2000 A 40 kA Gas Insulated Switchgear as per Ratings and Features RF IS7541(IEC) outdoor type (GIB) as per and DWG. No. BB-S-1-03/04 and BB-S-2-01/01	lot		THB	included	included			XXXXX	XXXXX		
2AB7-11	123 kV 2000 A 40 kA Gas Insulated Switchgear as per Ratings and Features RF IS7541(IEC) (Cable termination interface Plug-in type as per DWG. No. BB-S-1-03/04 and BB-S-2-01/01 )	lot		THB	included	included			XXXXX	XXXXX		
2AB7-12	123 kV 2000 A 40 kA Gas Insulated Switchgear as per Ratings and Features RF IS7541(IEC) (Female cable termination Plug-in type** as per Drawing No. BB-S-1-	lot		THB	included	included			XXXXX	XXXXX		
2AB7-13	Local control cubicle for IS7541 for item 2AB7-1 thru 2AB7-12*	8	set	THB	included	included			XXXXX	XXXXX		

  
 นางสุดารัตน์ ไชยพันธุ์  
 ผู้อำนวยการฝ่ายวิศวกรรมระบบส่ง

31 Aug 2022



อนันต์ ชัยพันธ์  
นางสาวอาสยา ช่างวิทยากา  
พจตส-ท.  
21 ก.ย. 2565

**MEDIUM COST FOR BID NO. RTS2-S-09**  
**2AB10 : Disconnecting Switch**  
**SUPPLY AND CONSTRUCTION OF 115 KV BHUMIBOL SUBSTATION (GIS)**  
**TRANSMISSION SYSTEM EXPANSION AND RENOVATION PROJECT PHASE 2**

Item No.	Description	Qty.	Unit	Currency	Supply of Equipment				Local Transportation, Construction and Installation (excluding VAT) Baht			
					Foreign Supply		Local Supply		Unit Price	Amount	Unit Price	Amount
					CIF Thai Port		Ex-works Price (excluding VAT) Baht					
					Unit Price	Amount	Unit Price	Amount	Unit Price	Amount		
2AB10-1	27 kV 1600 A 20 kA air switch vertical break manually gang operated as per Ratings and Features RF DS26D3(IEC) (phase spacing = 1.00 m)	2		THB	222,498.00	444,996.00			XXXXX	XXXXX		
2AB10-2	27 kV 1600 A 20 kA air switch 1 pole vertical break hook operated as per Ratings and Features RF DS26E3(IEC) (phase spacing = 1.00 m)	12		THB	74,166.00	889,992.00			XXXXX	XXXXX		
2AB10-3	Cost of Local Transportation, Construction and Installation for Item No. 2AB10-1 thru 2AB10-2	Lump sum	Lump sum		XXXXXX	XXXXXX	XXXXXX	XXXXXX	200,248.20	200,248.20		
				<b>THB</b>	<b>1,334,988.00</b>		<b>Baht</b>		<b>Baht</b>			
<b>Total Price for Schedule 2AB10</b>									<b>200,248.20</b>			

  
นางสุดารัตน์ ไชยพันธุ์  
ผู้อำนวยการฝ่ายวิศวกรรมระบบส่ง

31 Aug 2022

- Project 1-2C1 -

filename : RTS2-S-09-2 (115 kV BB)

อนันต์ ชื่นชื่น  
นางสาวอาสยา ช่างวิทยากา  
หจกตส-ท.  
21 ก.ย. 2565

**MEDIUM COST FOR BID NO. RTS2-S-09**  
**2AB11 : Power Fuse, Fuse Link and Hook Stick**  
**SUPPLY AND CONSTRUCTION OF 115 KV BHUMIBOL SUBSTATION (GIS)**  
**TRANSMISSION SYSTEM EXPANSION AND RENOVATION PROJECT PHASE 2**

Item No.	Description	Qty.	Unit	Currency	Supply of Equipment				Local Transportation, Construction and Installation (excluding VAT) Baht			
					Foreign Supply		Local Supply		Unit Price	Amount	Unit Price	Amount
					CIF Thai Port		Ex-works Price (excluding VAT) Baht					
					Unit Price	Amount	Unit Price	Amount	Unit Price	Amount		
2AB11-1	22 kV 100 A 12.5 kA 1-pole dropout fuse as per Ratings and Features RF PF2111 (Not including fuse link or refill unit)	3		THB	159,044.60	477,133.80			XXXXX	XXXXX		
2AB11-2	Fuse link or refill unit 40E for 22 kV power fuse (standard speed)	3		THB	12,764.40	38,293.20			XXXXX	XXXXX		
2AB11-3	Cost of Local Transportation, Construction and Installation for Item No. 2AB11-1 thru 2AB11-2	Lump sum	Lump sum		XXXXX	XXXXX	XXXXX	XXXXX	77,314.05	77,314.05		
				<b>THB</b>	<b>515,427.00</b>		<b>Baht</b>		<b>Baht</b>			
<b>Total Price for Schedule 2AB11</b>									<b>77,314.05</b>			

  
นางสุศารัตน์ ไชยพันธุ์  
ผู้อำนวยการฝ่ายวิศวกรรมระบบส่ง  
31 Aug 2022

**MEDIUM COST FOR BID NO. RTS2-S-09**  
**2AB12 : AC&DC Distribution Board and Termination Box**  
**SUPPLY AND CONSTRUCTION OF 115 KV BHUMIBOL SUBSTATION (GIS)**  
**TRANSMISSION SYSTEM EXPANSION AND RENOVATION PROJECT PHASE 2**

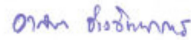
  
 นางสาวอาสยา ช่างวิทยากา  
 พจคส-ท.  
 21 ก.ย. 2565

Item No.	Description	Qty.	Unit	Currency	Supply of Equipment				Local Transportation, Construction and Installation (excluding VAT) Baht			
					Foreign Supply		Local Supply		Unit Price	Amount	Unit Price	Amount
					CIF Thai Port		Ex-works Price (excluding VAT) Baht					
					Unit Price	Amount	Unit Price	Amount	Unit Price	Amount		
2AB12-1	Termination Box type TB1 as per Dwg No. LT-TB-0-01	8						4,265.00	34,120.00	XXXXX	XXXXX	
2AB12-2	Outdoor Receptacle Box type ORB3 as per Dwg. No. SE-ORB-0-01	1						38,198.00	38,198.00	XXXXX	XXXXX	
2AB12-3	22kV 100A 12.5kA Load break switch with Cable Termination as per Ratings and Features RF LB2110	1						763,298.00	763,298.00	XXXXX	XXXXX	
2AB12-4	400/230 Vac Distribution Board as per Dwg. No. TP-E-4.2	1						220,187.00	220,187.00	XXXXX	XXXXX	
2AB12-5	125 Vdc Distribution Board as per Dwg. No. TP-E-4.4	1						142,168.00	142,168.00	XXXXX	XXXXX	
2AB12-6	Cost of Local Transportation, Construction and Installation for Item No. 2AB12-1 thru 2AB12-5	Lump sum	Lump sum					XXXXXX	XXXXXX	XXXXXX	XXXXXX	
								<b>Baht</b>		<b>Baht</b>		
<b>Total Price for Schedule 2AB12</b>								<b>1,197,971.00</b>		<b>179,695.65</b>		

นางสุดารัตน์ ไชยพันธุ์  
 ผู้อำนวยการฝ่ายวิศวกรรมระบบส่ง

31 Aug 2022

**MEDIUM COST FOR BID NO. RTS2-S-09**

**2AB14 : Substation Steel Structure**

**SUPPLY AND CONSTRUCTION OF 115 KV BHUMIBOL SUBSTATION (GIS)  
TRANSMISSION SYSTEM EXPANSION AND RENOVATION PROJECT PHASE 2**

อรุณ ชื่นจันทร์  
นางสาวอาสยา ชาญวิทยากา  
พจตล-ท.  
21 ก.ย. 2565

Item No.	Description	Qty.	Unit	Currency	Supply of Equipment				Local Transportation, Construction and Installation ( excluding VAT ) Baht			
					Foreign Supply		Local Supply					
					CIF Thai Port		Ex-works Price ( excluding VAT ) Baht		Unit Price	Amount	Unit Price	Amount
					Unit Price	Amount	Unit Price	Amount				
2AB14-1	115 kV take-off structure (TS702) as per Dwg. No. ST-TS-7-02	4					165,881.00	663,524.00	XXXXX	XXXXX		
2AB14-2	115 kV beam (BB703) as per Dwg. No. ST-BB-7-03	3					57,735.00	173,205.00	XXXXX	XXXXX		
2AB14-3	115 kV bus pole structure (BP706) as per Dwg. No. ST-BP-7-01	9					14,440.00	129,960.00	XXXXX	XXXXX		
2AB14-4	22 kV bus support structure (BS202) as per Dwg. No. ST-BS-2-02	4					50,841.00	203,364.00	XXXXX	XXXXX		
2AB14-5	22/33 kV deadend structure to PEA (DP401) as per Dwg. No. SD-DP-4-01	4					213,706.00	854,824.00	XXXXX	XXXXX		
2AB14-6	Overhead ground wire structure (OS3) as per Dwg. No. RS-TE106-C4.8	2					117,194.00	234,388.00	XXXXX	XXXXX		
2AB14-7	Disconnecting switch operating platform (OP002) as per Dwg. No. ST-OP-0-02	2					10,771.00	21,542.00	XXXXX	XXXXX		
2AB14-8	Junction box support structure (JB003) as per Dwg. No. ST-JB-0-03	1					7,325.00	7,325.00	XXXXX	XXXXX		

นางสุดารัตน์ ไชยพันธุ์  
ผู้อำนวยการฝ่ายวิศวกรรมระบบส่ง

31 Aug 2022



**MEDIUM COST FOR BID NO. RTS2-S-09**  
**2AB14 : Substation Steel Structure**  
**SUPPLY AND CONSTRUCTION OF 115 KV BHUMIBOL SUBSTATION (GIS)**  
**TRANSMISSION SYSTEM EXPANSION AND RENOVATION PROJECT PHASE 2**

Item No.	Description	Qty.	Unit	Currency	Supply of Equipment				Local Transportation, Construction and Installation (excluding VAT) Baht			
					Foreign Supply		Local Supply		Unit Price	Amount	Unit Price	Amount
					CIF Thai Port		Ex-works Price (excluding VAT) Baht					
					Unit Price	Amount	Unit Price	Amount	Unit Price	Amount		
2AB14-9	Cost of Local Transportation, Construction and Installation for Item No. 2AB14-1 thru 2AB14-8				XXXXX	XXXXX	XXXXX	XXXXX	858,049.50	858,049.50		
<b>Total Price for Schedule 2AB14</b>								<b>Baht 2,288,132.00</b>	<b>Baht 858,049.50</b>			

  
 นางสุตารัตน์ ไชยพันธุ์  
 ผู้อำนวยการฝ่ายวิศวกรรมระบบส่ง  
 31 Aug 2022

  
 นางสาวอาสยา ช่างวิทยากร  
 หจกส-ท.  
 21 ก.ย. 2565

นางสาวอัสยา ช่างวิทยากร  
 หจกส-ท.  
 21 ก.ย. 2565

**MEDIUM COST FOR BID NO. RTS2-S-09**

**2AB15 : Insulator**

**SUPPLY AND CONSTRUCTION OF 115 KV BHUMIBOL SUBSTATION (GIS)  
 TRANSMISSION SYSTEM EXPANSION AND RENOVATION PROJECT PHASE 2**

Item No.	Description	Qty.	Unit	Currency	Supply of Equipment				Local Transportation, Construction and Installation (excluding VAT) Baht			
					Foreign Supply		Local Supply		Unit Price	Amount	Unit Price	Amount
					CIF Thai Port		Ex-works Price (excluding VAT) Baht					
					Unit Price	Amount	Unit Price	Amount	Unit Price	Amount		
2AB15-1	Suspension insulator ANSI 52-3 as per Specification attached	Lump sum	Lump sum		supplied by EGAT	supplied by EGAT	supplied by EGAT	supplied by EGAT	XXXXX	XXXXX		
2AB15-2	115 kV station post insulator ANSI TR. No. 286	Lump sum	Lump sum		supplied by EGAT	supplied by EGAT	supplied by EGAT	supplied by EGAT	XXXXX	XXXXX		
2AB15-3	22 kV station post insulator ANSI TR. No. 208	Lump sum	Lump sum		supplied by EGAT	supplied by EGAT	supplied by EGAT	supplied by EGAT	XXXXX	XXXXX		
2AB15-4	Cost of Local Transportation, Construction and Installation for Item No. 2AB15-1 thru 2AB15-3	Lump sum	Lump sum		XXXXXX	XXXXXX	XXXXXX	XXXXXX	49,369.65	49,369.65		
<b>Total Price for Schedule 2AB15</b>							<b>Baht</b>		<b>Baht</b> 49,369.65			

  
 นางสุตารัตน์ ไชยพันธุ์  
 ผู้อำนวยการฝ่ายวิศวกรรมระบบส่ง  
 31 Aug 2022

นางสาวอภิสยา ช่างวิทยากร  
 หจก.ส.ท.  
 21 ก.ย. 2565

**MEDIUM COST FOR BID NO. RTS2-S-09**  
**2AB16 : Cable Terminations**  
**SUPPLY AND CONSTRUCTION OF 115 KV BHUMIBOL SUBSTATION (GIS)**  
**TRANSMISSION SYSTEM EXPANSION AND RENOVATION PROJECT PHASE 2**

Item No.	Description	Qty.	Unit	Currency	Supply of Equipment				Local Transportation, Construction and Installation (excluding VAT) Baht			
					Foreign Supply		Local Supply		Unit Price	Amount	Unit Price	Amount
					CIF Thai Port		Ex-works Price (excluding VAT) Baht					
					Unit Price	Amount	Unit Price	Amount	Unit Price	Amount		
2AB16-1	115 kV plug-in type cable terminations for 1/C no. 800 sq.mm. XLPE power cable as per Ratings and Features RF PTTN7D1X	27		THB	359,700.00	9,711,900.00			XXXXX	XXXXX		
2AB16-2	115 kV cable terminations for 1/C no. 800 sq.mm. XLPE power cable as per Ratings and Features RF TN7D1H	27		THB	273,900.00	7,395,300.00			XXXXX	XXXXX		
2AB16-3	22 kV cable terminations for 1/C no. 500 sq.mm. XLPE power cable as per Ratings and Features RF TN2B1H	24		THB	8,910.00	213,840.00			XXXXX	XXXXX		
2AB16-4	22 kV cable terminations for 1/C no. 35 sq.mm. XLPE power cable as per Ratings and Features RF TN212H	6		THB	5,453.80	32,722.80			XXXXX	XXXXX		
2AB16-5	Steel supporting structure for 115 kV cable terminations for item no.2AB16-2, the distance from live part to bottom of base plate of structure shall be H = 4.50 m, 1-phase set as per DWG. no. ST-TA-7-01	15		THB	38,777.20	581,658.00			XXXXX	XXXXX		
2AB16-6	Steel supporting structure for 115 kV cable terminations for item no.2AB16-2, the distance from live part to bottom of base plate of structure shall be H = 4.50 m, phase spacing shall be 2.25 m., 3-phase set (Designed by Contractor)*	4		THB	116,331.60	465,326.40			XXXXX	XXXXX		
2AB16-7	Cable Cleats with necessary miscellaneous hardware for item no. 2AB17-1, flat formation 1-phase set (Design by Contractor) as per RF no. TNAC1		Lump sum	THB	2,001,450.00	2,001,450.00			XXXXX	XXXXX		

นางสุดารัตน์ ไชยพันธุ์  
 ผู้อำนวยการฝ่ายวิศวกรรมระบบส่ง

31 Aug 2022

**MEDIUM COST FOR BID NO. RTS2-S-09**  
**2AB16 : Cable Terminations**  
**SUPPLY AND CONSTRUCTION OF 115 KV BHUMIBOL SUBSTATION (GIS)**  
**TRANSMISSION SYSTEM EXPANSION AND RENOVATION PROJECT PHASE 2**

Item No.	Description	Qty.	Unit	Currency	Supply of Equipment				Local Transportation, Construction and Installation (excluding VAT) Baht			
					Foreign Supply		Local Supply					
					CIF Thai Port		Ex-works Price (excluding VAT) Baht		Unit Price	Amount	Unit Price	Amount
					Unit Price	Amount	Unit Price	Amount				
2AB16-8	Cable Cleats with necessary miscellaneous hardware for item no. 2AB17-2, trefoil formation 3-phase set (Design by Contractor) as per RF no. TNAC1	Lump sum	Lump sum	THB	459,305.00	459,305.00			XXXXX	XXXXX		
2AB16-9	Cable Cleats with necessary miscellaneous hardware for item no. 2AB17-2, flat formation 1-phase set (Design by Contractor) as per RF no. TNAC1	Lump sum	Lump sum	THB	126,390.00	126,390.00			XXXXX	XXXXX		
2AB16-10	Cable Cleats with necessary miscellaneous hardware for item no. 2AB17-3, trefoil formation 3-phase set (Design by Contractor) as per RF no. TNAC1	Lump sum	Lump sum	THB	232,760.00	232,760.00			XXXXX	XXXXX		
2AB16-11	Cable Cleats with necessary miscellaneous hardware for item no. 2AB17-3, flat formation 1-phase set (Design by Contractor) as per RF no. TNAC1	Lump sum	Lump sum	THB	19,800.00	19,800.00			XXXXX	XXXXX		
2AB16-12	Cost of Local Transportation, Construction and Installation for Item No. 2AB16-1 thru 2AB16-11	Lump sum	Lump sum		XXXXXX	XXXXXX	XXXXXX	XXXXXX	7,965,169.58	7,965,169.58		
<b>Total Price for Schedule 2AB16</b>				THB	<b>21,240,452.20</b>		Baht		<b>Baht 7,965,169.58</b>			

\*The design of supporting structures of cable terminations shall be verified by cable terminations manufacturer.

นางสาว อาริษา ช่างวิทยากา  
 นางสาวอาริษา ช่างวิทยากา  
 วิศวกร  
 21 ก.ย. 2565

  
 นางสุภารัตน์ ไชยพันธุ์  
 ผู้อำนวยการฝ่ายวิศวกรรมระบบส่ง  
 31 Aug 2022

**MEDIUM COST FOR BID NO. RTS2-S-09**  
**2AB17 : XLPE Power Cable**  
**SUPPLY AND CONSTRUCTION OF 115 KV BHUMIBOL SUBSTATION (GIS)**  
**TRANSMISSION SYSTEM EXPANSION AND RENOVATION PROJECT PHASE 2**

Item No.	Description	Qty.	Unit	Currency	Supply of Equipment				Local Transportation, Construction and Installation ( excluding VAT ) Baht			
					Foreign Supply		Local Supply					
					CIF Thai Port		Ex-works Price ( excluding VAT ) Baht		Unit Price	Amount	Unit Price	Amount
					Unit Price	Amount	Unit Price	Amount				
2AB17-1	115 kV 1/C no. 800 sq.mm. XLPE power cable as per Specification attached	Lump sum	Lump sum				15,061,200.00	15,061,200.00	XXXXXX	XXXXXX		
2AB17-2	22 kV 1/C no. 500 sq.mm. XLPE power cable as per Ratings and Features RF PC2B10	Lump sum	Lump sum				5,121,600.00	5,121,600.00	XXXXXX	XXXXXX		
2AB17-3	22 kV 1/C no. 35 sq.mm. XLPE power cable as per Ratings and Features RF PC2110	Lump sum	Lump sum				359,700.00	359,700.00	XXXXXX	XXXXXX		
2AB17-4	Cost of Local Transportation, Construction and Installation for Item No. 2AB17-1 thru 2AB17-3	Lump sum	Lump sum		XXXXXX	XXXXXX	XXXXXX	XXXXXX	7,703,437.50	7,703,437.50		
<b>Total Price for Schedule 2AB17</b>							<b>Baht 20,542,500.00</b>		<b>Baht 7,703,437.50</b>			

  
 นางสุตารัตน์ ไชยพันธุ์  
 ผู้อำนวยการฝ่ายวิศวกรรมระบบส่ง  
 31 Aug 2022

  
 นางสาวอาสยา ช่างวิทยากา  
 หจกส.ท.  
 21 ก.ย. 2565

**MEDIUM COST FOR BID NO. RTS2-S-09**  
**2AB18 : Low Voltage Cable and Conductor**  
**SUPPLY AND CONSTRUCTION OF 115 KV BHUMIBOL SUBSTATION (GIS)**  
**TRANSMISSION SYSTEM EXPANSION AND RENOVATION PROJECT PHASE 2**

Item No.	Description	Qty.	Unit	Currency	Supply of Equipment				Local Transportation, Construction and Installation (excluding VAT) Baht				
					Foreign Supply		Local Supply						
					CIF Thai Port		Ex-works Price (excluding VAT) Baht		Unit Price	Amount	Unit Price	Amount	
					Unit Price	Amount	Unit Price	Amount					
2AB18-1	750 V power cable as per Specification attached	Lump sum	Lump sum				1,310,100.00	1,310,100.00	XXXXX	XXXXX			
2AB18-2	600 V control cable with PVC insulation as per Specification attached	Lump sum	Lump sum				770,770.00	770,770.00	XXXXX	XXXXX			
2AB18-3	750 V lighting cable (THW) as per Specification attached	Lump sum	Lump sum				6,600.00	6,600.00	XXXXX	XXXXX			
2AB18-4	Annealed copper ground wire as per Specification attached	Lump sum	Lump sum				1,628,598.40	1,628,598.40	XXXXX	XXXXX			
2AB18-5	Overhead ground wire as per Specification attached	Lump sum	Lump sum				3,432.00	3,432.00	XXXXX	XXXXX			
2AB18-6	Aluminum conductor as per Specification attached	Lump sum	Lump sum				82,249.20	82,249.20	XXXXX	XXXXX			
2AB18-7	Cost of Local Transportation, Construction and Installation for Item No. 2AB18-1 thru 2AB18-6	Lump sum	Lump sum			XXXXXX	XXXXXX	XXXXXX	XXXXXX	1,425,656.10	1,425,656.10		
<b>Total Price for Schedule 2AB18</b>							<b>Baht</b>				<b>3,801,749.60</b>	<b>Baht</b>	<b>1,425,656.10</b>

  
 นางสาวศุติรัตน์ ไชยพันธุ์  
 ผู้อำนวยการฝ่ายวิศวกรรมระบบส่ง  
 31 Aug 2022

  
 นางสาวอาสยา ช่างวิทยากา  
 วิศวศ-ท.  
 21 ก.ย. 2565

**MEDIUM COST FOR BID NO. RTS2-S-09**  
**2AB19 : Switchyard Lighting Fixtures**  
**SUPPLY AND CONSTRUCTION OF 115 KV BHUMIBOL SUBSTATION (GIS)**  
**TRANSMISSION SYSTEM EXPANSION AND RENOVATION PROJECT PHASE 2**

Item No.	Description	Qty.	Unit	Currency	Supply of Equipment				Local Transportation, Construction and Installation (excluding VAT) Baht			
					Foreign Supply		Local Supply		Unit Price	Amount	Unit Price	Amount
					CIF Thai Port		Ex-works Price (excluding VAT) Baht					
					Unit Price	Amount	Unit Price	Amount	Unit Price	Amount		
2AB19-1	Flood lighting fixture, LED lamp, 10000 lumen, wide-beam, complete with control gear as per Specification attached	10					15,082.00	150,820.00	XXXXX	XXXXX		
2AB19-2	Cost of Local Transportation, Construction and Installation for Item No. 2AB19-1	Lump sum	Lump sum		XXXXX	XXXXX	XXXXX	XXXXX	56,557.50	56,557.50		
							<b>Baht</b>	<b>150,820.00</b>	<b>Baht</b>	<b>56,557.50</b>		
<b>Total Price for Schedule 2AB19</b>												

  
 นางสุตารัตน์ ไชยพันธุ์  
 ผู้อำนวยการฝ่ายวิศวกรรมระบบส่ง  
 31 Aug 2022

  
 นางสาวอัสยา ช่างวิทยากร  
 วิศวศส-ท.  
 21 ก.ย. 2565

**MEDIUM COST FOR BID NO. RTS2-S-09**  
**2AB20 : Aluminum Tube, Connector and Miscellaneous Hardware**  
**SUPPLY AND CONSTRUCTION OF 115 KV BHUMIBOL SUBSTATION (GIS)**  
**TRANSMISSION SYSTEM EXPANSION AND RENOVATION PROJECT PHASE 2**

ตาม ที่อธิบดี  
 นางสาวอาสยา ช่างวิทยากา  
 ทจตส-ท.  
 21 ก.ย. 2565

Item No.	Description	Qty.	Unit	Currency	Supply of Equipment				Local Transportation, Construction and Installation (excluding VAT) Baht			
					Foreign Supply		Local Supply					
					CIF Thai Port		Ex-works Price (excluding VAT) Baht		Unit Price	Amount	Unit Price	Amount
					Unit Price	Amount	Unit Price	Amount				
2AB20-1	Aluminum tube as per Specification attached	Lump sum	Lump sum				51,462.40	51,462.40	XXXXX	XXXXX		
2AB20-2	115 kV and below Compression connector as per Specification attached	Lump sum	Lump sum				76,903.20	76,903.20	XXXXX	XXXXX		
2AB20-3	115 kV and below Miscellaneous hardware as per Specification attached	Lump sum	Lump sum				43,330.68	43,330.68	XXXXX	XXXXX		
2AB20-4	Cost of Local Transportation, Construction and Installation for Item No. 2AB20-1 thru 2AB20-3	Lump sum	Lump sum		XXXXX	XXXXX	XXXXX	XXXXX	64,386.11	64,386.11		
<b>Total Price for Schedule 2AB20</b>							<b>Baht 171,696.28</b>		<b>Baht 64,386.11</b>			

  
 นางสุดารัตน์ ไชยพันธุ์  
 ผู้อำนวยการฝ่ายวิศวกรรมระบบส่ง



**MEDIUM COST FOR BID NO. RTS2-S-09**

**2AB21 : Bus Fitting**

**SUPPLY AND CONSTRUCTION OF 115 KV BHUMIBOL SUBSTATION (GIS)  
TRANSMISSION SYSTEM EXPANSION AND RENOVATION PROJECT PHASE 2**

Item No.	Description	Qty.	Unit	Currency	Supply of Equipment				Local Transportation, Construction and Installation (excluding VAT) Baht			
					Foreign Supply		Local Supply					
					CIF Thai Port		Ex-works Price (excluding VAT) Baht		Unit Price	Amount	Unit Price	Amount
					Unit Price	Amount	Unit Price	Amount				
2AB21-1	115 kV and below Bus fitting as per Specification attached	Lump sum	Lump sum	THB	227,247.93	227,247.93			XXXXX	XXXXX		
2AB21-2	Cost of Local Transportation, Construction and Installation for Item No. 2AB21-1	Lump sum	Lump sum		XXXXX	XXXXX	XXXXX	XXXXX	85,217.97	85,217.97		
<b>Total Price for Schedule 2AB21</b>				THB	227,247.93		Baht		Baht 85,217.97			

  
 นางสาวสุตารัตน์ ไชยพันธุ์  
 ผู้อำนวยการฝ่ายวิศวกรรมระบบส่ง  
 31 Aug 2022

  
 นางสาวอาสยา ช่างวิทยากาน  
 หจกส-ท.  
 21 ก.ย. 2565

**MEDIUM COST FOR BID NO. RTS2-S-09**  
**2AB22 : Grounding Material**  
**SUPPLY AND CONSTRUCTION OF 115 KV BHUMIBOL SUBSTATION (GIS)**  
**TRANSMISSION SYSTEM EXPANSION AND RENOVATION PROJECT PHASE 2**

Item No.	Description	Qty.	Unit	Currency	Supply of Equipment				Local Transportation, Construction and Installation (excluding VAT) Baht			
					Foreign Supply		Local Supply		Unit Price	Amount	Unit Price	Amount
					CIF Thai Port		Ex-works Price (excluding VAT) Baht					
					Unit Price	Amount	Unit Price	Amount	Unit Price	Amount		
2AB22-1	Thermite welding material as per Specification attached	Lump sum	Lump sum				289,446.64	289,446.64	XXXXX	XXXXX		
2AB22-2	Grounding hardware as per Specification attached	Lump sum	Lump sum	THB	281,287.13	281,287.13			XXXXX	XXXXX		
2AB22-3	Cost of Local Transportation, Construction and Installation for Item No. 2AB22-1 thru 2AB22-2	Lump sum	Lump sum		XXXXX	XXXXX	XXXXX	XXXXX	214,025.16	214,025.16		
<b>Total Price for Schedule 2AB22</b>				THB	<b>281,287.13</b>		Baht	<b>289,446.64</b>		Baht	<b>214,025.16</b>	

  
นางสุดารัตน์ ไชยพันธุ์  
ผู้อำนวยการฝ่ายวิศวกรรมระบบส่ง  
31 Aug 2022

  
นางสาวอาสยา ช่างวิทยากา  
ทจตส-ท.  
21 ก.ย. 2565

**MEDIUM COST FOR BID NO. RTS2-S-09**  
**2AB23 : Substation Miscellaneous**  
**SUPPLY AND CONSTRUCTION OF 115 KV BHUMIBOL SUBSTATION (GIS)**  
**TRANSMISSION SYSTEM EXPANSION AND RENOVATION PROJECT PHASE 2**

Item No.	Description	Qty.	Unit	Currency	Supply of Equipment				Local Transportation, Construction and Installation (excluding VAT) Baht			
					Foreign Supply		Local Supply		Unit Price	Amount	Unit Price	Amount
					CIF Thai Port		Ex-works Price (excluding VAT) Baht					
					Unit Price	Amount	Unit Price	Amount				
2AB23-1	Rigid steel conduit as per Specification attached	Lump sum	Lump sum				76,929.60	76,929.60	XXXXX	XXXXX		
2AB23-2	Fitting for rigid steel conduit as per Specification attached	Lump sum	Lump sum	THB	29,814.40	29,814.40			XXXXX	XXXXX		
2AB23-3	HDPE conduit and fitting as per Specification attached	Lump sum	Lump sum				16,602.80	16,602.80	XXXXX	XXXXX		
2AB23-4	Identification and danger notice plate as per drawing attached	Lump sum	Lump sum				357,720.00	357,720.00	XXXXX	XXXXX		
2AB23-5	Cost of Local Transportation, Construction and Installation for Item No. 2AB23-1 thru 2AB23-4	Lump sum	Lump sum		XXXXXX	XXXXXX	XXXXXX	XXXXXX	180,400.05	180,400.05		
				<b>THB</b>	<b>29,814.40</b>		<b>Baht</b>		<b>Baht</b>			
<b>Total Price for Schedule 2AB23</b>							<b>451,252.40</b>		<b>180,400.05</b>			

  
 นางสาวศุฑารัตน์ ไชยพันธ์  
 ผู้อำนวยการฝ่ายวิศวกรรมระบบส่ง  
 31 Aug 2022

  
 นางสาวอาสยา ช่างวิทยากา  
 หจก.ส.ท.

**MEDIUM COST FOR BID NO. RTS2-S-09**  
**2AB24 : Control and Protection System**  
**SUPPLY AND CONSTRUCTION OF 115 KV BHUMIBOL SUBSTATION (GIS)**  
**TRANSMISSION SYSTEM EXPANSION AND RENOVATION PROJECT PHASE 2**

Item No.	Description	Drawing No. / Reference No.	Qty.	Unit	Currency	Supply of Equipment				Local Transportation, Construction and Installation (excluding VAT) Baht			
						Foreign Supply		Local Supply					
						CIF Thai Port		Ex-works Price (excluding VAT) Baht		Unit Price	Amount	Unit Price	Amount
						Unit Price	Amount	Unit Price	Amount				
2AB24-1	DIGITAL SUBSTATION SYSTEM -- Protective IED Panel (For 115kV BUS PROTECTION and COUPLE BAY)	Panel No. 21R Specification No. 1008 See Scope of Work and Note Drawing Nos. BB-E-1 sh.1-4, BB-E-2.1 sh.1-2, BB-E-2.2 sh.1-2, BB-E-3.1 sh.1-2, BB-E-3.2, TP-E-10.1 and TP-E-20.3	1	Ea				3,667,093	3,667,093.00	XXXXX	XXXXX		
2AB24-2	DIGITAL SUBSTATION SYSTEM -- Protective IED Panel (For 115kV Line NO.1&2 to THOEN and Line to TAK1)	Panel No. 22R Specification No. 1008 See Scope of Work and Note Drawing Nos. BB-E-1 sh.1-4, BB-E-2.1 sh.1-2, BB-E-2.2 sh.1-2, BB-E-3.1 sh.1-2, BB-E-3.2, TP-E-10.1 and TP-E-20.3	1	Ea				4,703,004	4,703,004.00	XXXXX	XXXXX		

  
นางสุตารัตน์ ไชยพันธุ์  
ผู้อำนวยการฝ่ายวิศวกรรมระบบส่ง  
31 Aug 2022

  
นางสาวอาสยา ช่างวิทยากา  
หจคส.พ.  
21 ก.ย. 2565

**MEDIUM COST FOR BID NO. RTS2-S-09**  
**2AB24 : Control and Protection System**  
**SUPPLY AND CONSTRUCTION OF 115 KV BHUMIBOL SUBSTATION (GIS)**  
**TRANSMISSION SYSTEM EXPANSION AND RENOVATION PROJECT PHASE 2**

Item No.	Description	Drawing No. / Reference No.	Qty.	Unit	Currency	Supply of Equipment				Local Transportation, Construction and Installation (excluding VAT) Baht			
						Foreign Supply		Local Supply					
						CIF Thai Port		Ex-works Price (excluding VAT) Baht		Unit Price	Amount	Unit Price	Amount
						Unit Price	Amount	Unit Price	Amount				
2AB24-3	DIGITAL SUBSTATION SYSTEM -- Protective IED Panel (For 115/22 kV KT3A, KT4A, 22kV Line NO.1&2 to PEA and 22kV Line NO.1&2 to CAMP AREA)	Panel Nos. 23R and 24R Specification No. 1008 See Scope of Work and Note Drawing Nos. BB-E-1 sh.1-4, BB-E-2.1 sh.1-2, BB-E-2.2 sh.1-2, BB-E-3.1 sh.1-2, BB-E-3.2, TP-E-10.1 and TP-E-20.3	2	Ea				2,327,530	4,655,060.00	XXXXX	XXXXX		
2AB24-4	DIGITAL SUBSTATION SYSTEM -- BCU Panel	Panel No. BCU-21 and BCU-22 Specification No. 1008 See Scope of Work and Note Drawing Nos. BB-E-1 sh.1-4, BB-E-2.1 sh.1-2, BB-E-2.2 sh.1-2, BB-E-3.1 sh.1-2, BB-E-3.2, TP-E-10.1 and TP-E-20.3	2	Ea				3,495,547	6,991,094.00	XXXXX	XXXXX		

  
นางสุตารัตน์ ไชยพันธ์  
ผู้อำนวยการฝ่ายวิศวกรรมระบบส่ง  
31 Aug 2022

  
นางสาวอาสยา ช่างวิทยากา  
หจกส-ท.  
21 ก.ย. 2565

**MEDIUM COST FOR BID NO. RTS2-S-09**  
**2AB24 : Control and Protection System**  
**SUPPLY AND CONSTRUCTION OF 115 KV BHUMIBOL SUBSTATION (GIS)**  
**TRANSMISSION SYSTEM EXPANSION AND RENOVATION PROJECT PHASE 2**

Item No.	Description	Drawing No. / Reference No.	Qty.	Unit	Currency	Supply of Equipment				Local Transportation, Construction and Installation (excluding VAT) Baht			
						Foreign Supply		Local Supply					
						CIF Thai Port		Ex-works Price (excluding VAT) Baht		Unit Price	Amount	Unit Price	Amount
						Unit Price	Amount	Unit Price	Amount				
2AB24-5	DIGITAL SUBSTATION SYSTEM -- METERING PANEL (4 KWH&KVARH METERS)	Panel No. MP2 and MP3 See Scope of Work Drawing Nos. BB-E-1 sh.1-4, BB-E-2.1 sh.1-2, BB-E-2.2 sh.1-2, BB-E-3.1 sh.1-2, BB-E-3.2, and TP-E-10.1	2	Ea				1,466,234	2,932,468.00	XXXXX	XXXXX		
2AB24-6	DIGITAL SUBSTATION SYSTEM -- Merging Unit Panel (for GIS:1-BKR, 3-DS, 1-CT, 1-VT)	Panel Nos. MUC700-1, MUC701-1, MUC702-1, MUC703-1, MUC705-1 and MUC706-1 Specification No. 1008 See Scope of Work and Note Drawing Nos. BB-E-1 sh.1-4, BB-E-2.1 sh.1-2, BB-E-2.2 sh.1-2, BB-E-3.1 sh.1-2 and BB-E-3.2	6	Ea				2,979,445	17,876,670.00	XXXXX	XXXXX		

  
นางสุดารัตน์ ไชยพันธุ์  
ผู้อำนวยการฝ่ายวิศวกรรมระบบส่ง

31 Aug 2022

  
นางสาวอาสยา ช่างวิทยากา  
ทจตส.ท.  
21 ก.ย. 2565

**MEDIUM COST FOR BID NO. RTS2-S-09**  
**2AB24 : Control and Protection System**  
**SUPPLY AND CONSTRUCTION OF 115 KV BHUMIBOL SUBSTATION (GIS)**  
**TRANSMISSION SYSTEM EXPANSION AND RENOVATION PROJECT PHASE 2**

Item No.	Description	Drawing No. / Reference No.	Qty.	Unit	Currency	Supply of Equipment				Local Transportation, Construction and Installation (excluding VAT) Baht			
						Foreign Supply		Local Supply					
						CIF Thai Port		Ex-works Price (excluding VAT) Baht		Unit Price	Amount	Unit Price	Amount
						Unit Price	Amount	Unit Price	Amount				
2AB24-7	DIGITAL SUBSTATION SYSTEM -- Merging Unit Panel (for 1-TX)	Panel Nos. MUC707-1 and MUC708-1 Specification No. 1008 See Scope of Work and Note Drawing Nos. BB-E-1 sh.1-4, BB-E-2.1 sh.1-2, BB-E-2.2 sh.1-2, BB-E-3.1 sh.1-2 and BB-E-3.2	2	Ea				2,143,743	4,287,486.00	XXXXX	XXXXX		



นางศุฑารัตน์ ไชยพันธุ์  
 ผู้อำนวยการฝ่ายวิศวกรรมระบบส่ง

31 Aug 2022

อรุณ ชิงฉิมพาร  
 นางสาวอสาชา ช่างวิทยากท  
 หจตส-ท.  
 21 ก.ย. 2565

**MEDIUM COST FOR BID NO. RTS2-S-09**  
**2AB24 : Control and Protection System**  
**SUPPLY AND CONSTRUCTION OF 115 KV BHUMIBOL SUBSTATION (GIS)**  
**TRANSMISSION SYSTEM EXPANSION AND RENOVATION PROJECT PHASE 2**

Item No.	Description	Drawing No. / Reference No.	Qty.	Unit	Currency	Supply of Equipment				Local Transportation, Construction and Installation (excluding VAT) Baht			
						Foreign Supply		Local Supply					
						CIF Thai Port		Ex-works Price (excluding VAT) Baht		Unit Price	Amount	Unit Price	Amount
						Unit Price	Amount	Unit Price	Amount				
2AB24-8	DS0MP-04DIGITAL SUBSTATION SYSTEM -- Merging Unit Panel (for Switchgear)	Panel Nos. MUC707-2 and MUC708-2 Specification No. 1008 See Scope of Work and Note Drawing Nos. BB-E-1 sh.1-4, BB-E-2.1 sh.1-2, BB-E-2.2 sh.1-2, BB-E-3.1 sh.1-2 and BB-E-3.2	2	Ea				2,143,743	4,287,486.00	XXXXX	XXXXX		
2AB24-9	Cost of Local Transportation, Construction and Installation for Item No.2AB24-1 thru 2AB24-8		Lump sum	Lump sum			XXXXX	XXXXX	XXXXX	XXXXX	4,940,031.58	4,940,031.58	
<b>Total Price for Schedule 2AB24</b>								<b>Baht 49,400,361.00</b>		<b>Baht 4,940,031.58</b>			

  
 นางสุตารัตน์ ไชยพันธุ์  
 ผู้อำนวยการฝ่ายวิศวกรรมระบบส่ง  
 31 Aug 2022

  
 นางสาวอัสยา ช่างวิทยากา  
 หจตส-ท.  
 21 ก.ย. 2565



**MEDIUM COST FOR BID NO. RTS2-S-09**  
**2AB25 : Fault Recording System**  
**SUPPLY AND CONSTRUCTION OF 115 KV BHUMIBOL SUBSTATION (GIS)**  
**TRANSMISSION SYSTEM EXPANSION AND RENOVATION PROJECT PHASE 2**

Item No.	Description	Drawing No. / Reference No.	Qty.	Unit	Currency	Supply of Equipment				Local Transportation, Construction and Installation (excluding VAT) Baht			
						Foreign Supply		Local Supply					
						CIF Thai Port		Ex-works Price (excluding VAT) Baht		Unit Price	Amount	Unit Price	Amount
						Unit Price	Amount	Unit Price	Amount				
2AB25-1	FAULT RECORDING SYSTEM, 64 ANALOG INPUT, 128 DIGITAL INPUT.	Installed at 230/115kV Control Room. Specification Nos. 1003 and 1008 Drawing Nos. BB-E-1 sh.1-4 and TP-E-20.3	1	SET				3,403,026	3,403,026.00	XXXXX	XXXXX		
2AB25-2	Cost of Local Transportation, Construction and Installation for Item No. 2AB25-1		Lump sum	Lump sum			XXXXX	XXXXX	XXXXX	XXXXX	340,302.00	340,302.00	
<b>Total Price for Schedule 2AB25</b>								<b>Baht 3,403,026.00</b>		<b>Baht 340,302.00</b>			

  
 นางสุดารัตน์ ไชยพันธุ์  
 ผู้อำนวยการฝ่ายวิศวกรรมระบบส่ง  
 31 Aug 2022

  
 นางสาวอัสยา ช่างวิทยากา  
 หจกตส-ท.  
 21 ก.ย. 2565

**MEDIUM COST FOR BID NO. RTS2-S-09**

**2AB37 : Medium Voltage Switchgear**

**SUPPLY AND CONSTRUCTION OF 115 KV BHUMIBOL SUBSTATION (GIS)  
TRANSMISSION SYSTEM EXPANSION AND RENOVATION PROJECT PHASE 2**

Item No.	Description	Qty.	Unit	Currency	Supply of Equipment				Local Transportation, Construction and Installation (excluding VAT) Baht			
					Foreign Supply		Local Supply		Unit Price	Amount	Unit Price	Amount
					CIF Thai Port		Ex-works Price (excluding VAT) Baht					
					Unit Price	Amount	Unit Price	Amount	Unit Price	Amount		
2AB37-1	24 kV 1250 A 25 kA metal-clad Gas Insulated Switchgear as per Ratings and Features RF MS2521(IEC) , modular design, single row arrangement, indoor, free standing, complete with end covers, cable termination(socket and plug), dummy plugs for future feeders*, control protection and accessories (see Dwg. No. BB-S-1-04/04) (Switchgear No.1)	1		THB	6,135,312.00	6,135,312.00			XXXXX	XXXXX		
2AB37-2	24 kV 1250 A 25 kA metal-clad Gas Insulated Switchgear as per Ratings and Features RF MS2521(IEC) , modular design, single row arrangement, indoor, free standing, complete with end covers, cable termination(socket and plug), dummy plugs for future feeders*, control protection and accessories (see Dwg. No. BB-S-1-04/04) (Switchgear No.2)	1		THB	6,135,312.00	6,135,312.00			XXXXX	XXXXX		
2AB37-3	Accessories and special tools necessary for medium voltage switchgear (If any)	lot		THB	70,277.00	70,277.00			XXXXX	XXXXX		



นางสุดารัตน์ ไชยพันธุ์  
ผู้อำนวยการฝ่ายวิศวกรรมระบบส่ง

31 Aug 2022



นางสาวอาสยา ช่างวิทยากร  
หจกส-ท.

21 ก.ย. 2565

**MEDIUM COST FOR BID NO. RTS2-S-09**  
**2AB37 : Medium Voltage Switchgear**  
**SUPPLY AND CONSTRUCTION OF 115 KV BHUMIBOL SUBSTATION (GIS)**  
**TRANSMISSION SYSTEM EXPANSION AND RENOVATION PROJECT PHASE 2**

Item No.	Description	Qty.	Unit	Currency	Supply of Equipment				Local Transportation, Construction and Installation (excluding VAT) Baht			
					Foreign Supply		Local Supply		Ex-works Price (excluding VAT) Baht			
					CIF Thai Port							
					Unit Price	Amount	Unit Price	Amount	Unit Price	Amount		
2AB37-4	Cost of Local Transportation, Construction and Installation for Item No. 2AB37-1 thru 2AB37-3				XXXXXX	XXXXXX	XXXXXX	XXXXXX	232,856.00	232,856.00		
		Lump sum	Lump sum									
<b>Total Price for Schedule 2AB37</b>				<b>THB</b>	<b>12,340,901.00</b>		<b>Baht</b>		<b>Baht 232,856.00</b>			

\* shall be able to withstand rated insulation level of the metal-clad Gas Insulated Switchgear

  
 นางสุดารัตน์ ไชยพันธุ์  
 ผู้อำนวยการฝ่ายวิศวกรรมระบบส่ง  
 31 Aug 2022

  
 นางสาวอาสยา ช่างวิทยากา  
 หจกตส-ท.  
 21 ก.ย. 2565

**MEDIUM COST FOR BID NO. RTS2-S-09**  
**2AB39 : Commissioning**  
**SUPPLY AND CONSTRUCTION OF 115 KV BHUMIBOL SUBSTATION (GIS)**  
**TRANSMISSION SYSTEM EXPANSION AND RENOVATION PROJECT PHASE 2**

Item No.	Description	Qty.	Unit	Currency	Supply of Equipment				Local Transportation, Construction and Installation (excluding VAT) Baht			
					Foreign Supply		Local Supply		Unit Price	Amount	Unit Price	Amount
					CIF Thai Port		Ex-works Price (excluding VAT) Baht					
					Unit Price	Amount	Unit Price	Amount	Unit Price	Amount		
2AB39-1	Commissioning	Lump sum	Lump sum		XXXXX	XXXXX	XXXXX	XXXXX	900,000.00	900,000.00		
<b>Total Price for Schedule 2AB39</b>							<b>Baht</b>		<b>Baht</b> <b>900,000.00</b>			

  
 นางสาวรัตน์ ไชยพันธุ์  
 ผู้อำนวยการฝ่ายวิศวกรรมระบบส่ง  
 31 Aug 2022

  
 นางสาวอาสยา ช่างวิทยากา  
 หจกส-ท.  
 21 ก.ย. 2565

**MEDIUM COST FOR BID NO. RTS2-S-09**  
**2AB40 : Installation of Equipment and Steel Structure Supplied by EGAT**  
**SUPPLY AND CONSTRUCTION OF 115 KV BHUMIBOL SUBSTATION (GIS)**  
**TRANSMISSION SYSTEM EXPANSION AND RENOVATION PROJECT PHASE 2**

Item No.	Description	Qty.	Unit	Currency	Supply of Equipment				Local Transportation, Construction and Installation (excluding VAT) Baht			
					Foreign Supply		Local Supply		Unit Price	Amount	Unit Price	Amount
					CIF Thai Port		Ex-works Price (excluding VAT) Baht					
					Unit Price	Amount	Unit Price	Amount	Unit Price	Amount		
2AB40-1	Dismantlement	Lump sum	Lumpsum		XXXXX	XXXXX	XXXXX	XXXXX	40,000.00	40,000.00		
<b>Total Price for Schedule 2AB40</b>							<b>Baht</b>		<b>Baht 40,000.00</b>			

  
 นางสุตารัตน์ ไชยพันธุ์  
 ผู้อำนวยการฝ่ายวิศวกรรมระบบส่ง  
 31 Aug 2022

  
 นางสาวอาสยา ช่างวิทยากร  
 ทจตส-ท.  
 21 ก.ย. 2565

**MEDIUM COST FOR BID NO. RTS2-S-09**  
**2C1 : Foundation Work**  
**SUPPLY AND CONSTRUCTION OF 115 KV BHUMIBOL SUBSTATION (GIS)**  
**TRANSMISSION SYSTEM EXPANSION AND RENOVATION PROJECT PHASE 2**

Item No.	Description	Drawing No. / Reference No.	Qty.	Unit	Local Currency (excluding VAT) Baht	
					Unit Price	Amount
2C1-1	115 kV Take off Structure Foundation (TS702) Pile Type (Dowel bar , Pile cut off and Pile shoe are included)	FD-TS-7-07 01/01, SD-PL-0-01	4	set	80,778.00	323,112.00
2C1-2	115/230 kV General equipment support structure foundation (BP701,BP801,CC704,CT702,CT802,VT703,VT803, LA401, LA402, LA801, LA802) Pad Type (VT703 only)	FD-GE-0-01 01/01	9	set	14,248.00	128,232.00
2C1-3	115 kV Cable riser support structure foundation (TM702) Pad Type	FD-TM-7-03 01/01	24	set	26,818.00	643,632.00
2C1-4	115/230 kV General equipment support structure foundation (BP701,BP801,CC704,CT702,CT802,VT703,VT803, LA401, LA402, LA801, LA802) Pad Type (LA701 only)	FD-GE-0-01 01/01	9	set	14,248.00	128,232.00



นางสุดารัตน์ ไชยพันธุ์  
 ผู้อำนวยการฝ่ายวิศวกรรมระบบส่ง

31 Aug 2022



นางสาวอัสยา ช่างวิทยากร  
 ทจคส.ท.

21 ก.ย. 2565

**MEDIUM COST FOR BID NO. RTS2-S-09**  
**2C1 : Foundation Work**  
**SUPPLY AND CONSTRUCTION OF 115 KV BHUMIBOL SUBSTATION (GIS)**  
**TRANSMISSION SYSTEM EXPANSION AND RENOVATION PROJECT PHASE 2**

*อาภา ชื่นชื่น*  
 นางสาวอาสยา ช่างวิทยากร  
 หจกส-ท.  
 21 ก.ย. 2565

Item No.	Description	Drawing No. / Reference No.	Qty.	Unit	Local Currency (excluding VAT) Baht	
					Unit Price	Amount
2C1-5	115/230 kV General equipment support structure foundation (BP701,BP801,CC704,CT702,CT802,VT703,VT803, LA401, LA402, LA801, LA802) Pad Type (BP701 only)	FD-GE-0-01 01/01	9	set	14,248.00	128,232.00
2C1-6	22 kV Bus support structure foundation (BS201,BS202,BS203,BS204) Pad Type (BS202 only)	FD-BS-2-01 01/01	4	set	23,624.00	94,496.00
2C1-7	22kV. Dead end support structure foundation (DP401)	Designed by Contractor, TT/FD-DP-4-01, See Scope of work	4	set	118,891.00	475,564.00
2C1-8	69/230 kV Overhead groundwire structure foundation (OHG) Pad Type	FD-OG-0-01 01/01	2	set	133,406.00	266,812.00
2C1-9	Disconnecting Switch Operating Platform foundation (OP002)	FD-OP-0-02 01/01	2	set	2,767.00	5,534.00

  
 นางสุดารัตน์ ไชยพันธุ์  
 ผู้อำนวยการฝ่ายวิศวกรรมระบบส่ง

31 Aug 2022

อนันต์ ชัยวัฒน์  
นางสาวอาสยา ช่างวิทยากา  
พจตส-ท.  
21 ก.ย. 2565

**MEDIUM COST FOR BID NO. RTS2-S-09**  
**2C1 : Foundation Work**  
**SUPPLY AND CONSTRUCTION OF 115 KV BHUMIBOL SUBSTATION (GIS)**  
**TRANSMISSION SYSTEM EXPANSION AND RENOVATION PROJECT PHASE 2**

Item No.	Description	Drawing No. / Reference No.	Qty.	Unit	Local Currency (excluding VAT) Baht	
					Unit Price	Amount
2C1-10	Transformer Foundation (T-125) Pad Type	FD-TX-7-01 01/01	2	set	133,998.00	267,996.00
2C1-11	Outdoor marshalling Cubicle foundation and Sub-Trench (MC002) Pad Type	FD-MC-0-06 01/01	2	set	10,749.00	21,498.00
2C1-12	Junction Box Structure foundation (JB003) Pad Type	FD-JB-0-05 01/01	1	set	7,531.00	7,531.00
2C1-13	Fire Wall 8.00m Height (FW) Pad Type	FD-FW-0-01 01/01	1	set	634,234.00	634,234.00
2C1-14	Outdoor Load Break Switch foundation. (LBS)	Designed by Contractor, FD-DX-4-01 01/01, See Scope of work	1	set	12,379.00	12,379.00
					<b>Baht</b>	<b>3,137,484.00</b>
 <b>Total Price for Schedule 2C1</b>						

นางสุดารัตน์ ไชยพันธุ์  
ผู้อำนวยการฝ่ายวิศวกรรมระบบส่ง

31 Aug 2022



**MEDIUM COST FOR BID NO. RTS2-S-09**  
**2C1 : Foundation Work**  
**SUPPLY AND CONSTRUCTION OF 115 KV BHUMIBOL SUBSTATION (GIS)**  
**TRANSMISSION SYSTEM EXPANSION AND RENOVATION PROJECT PHASE 2**

Item No.	Description	Drawing No. / Reference No.	Qty.	Unit	Local Currency (excluding VAT) Baht	
					Unit Price	Amount
<b>Total Price for Schedule 2C1</b>						



นางสุตารัตน์ ไชยพันธุ์  
 ผู้อำนวยการฝ่ายวิศวกรรมระบบส่ง

31 Aug 2022



นางสาวอาสยา ช่างวิทยากร  
 หงตส-ท.

21 ก.ย. 2565

**MEDIUM COST FOR BID NO. RTS2-S-09**  
**2C4 : Earth Work, Road and Crushed Rock Surfacing**  
**SUPPLY AND CONSTRUCTION OF 115 KV BHUMIBOL SUBSTATION (GIS)**  
**TRANSMISSION SYSTEM EXPANSION AND RENOVATION PROJECT PHASE 2**

Item No.	Description	Drawing No. / Reference No.	Qty.	Unit	Local Currency (excluding VAT) Baht		
					Unit Price	Amount	
2C4-1	Transformer loading	SD-RD-0-03 01/01		Lump Sum	Lump Sum	50,220.00	50,220.00
<b>Total Price for Schedule 2C4</b>						<b>Baht</b>	<b>50,220.00</b>

  
 นางสุดารัตน์ ไชยพันธุ์  
 ผู้อำนวยการฝ่ายวิศวกรรมระบบส่ง  
 31 Aug 2022

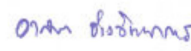
  
 นางสาวอาสยา ช่างวิทยากา  
 หจกส-ท.  
 21 ก.ย. 2565

**MEDIUM COST FOR BID NO. RTS2-S-09**  
**2C6 : Drainage System**  
**SUPPLY AND CONSTRUCTION OF 115 KV BHUMIBOL SUBSTATION (GIS)**  
**TRANSMISSION SYSTEM EXPANSION AND RENOVATION PROJECT PHASE 2**

Item No.	Description	Drawing No. / Reference No.	Qty.	Unit	Local Currency (excluding VAT) Baht		
					Unit Price	Amount	
2C6-1	Oil pit with steel grating	WD-DN-0-04 01/01		Lump Sum	Lump Sum	932,976.00	932,976.00
<b>Total Price for Schedule 2C6</b>						<b>Baht</b>	<b>932,976.00</b>

  
 นางสุตารัตน์ ไชยพันธุ์  
 ผู้อำนวยการฝ่ายวิศวกรรมระบบส่ง  
 31 Aug 2022

  
 นางสาวอาสยา ช่างวิทยากาน  
 ทจตส.ท.  
 21 ก.ย. 2565

**MEDIUM COST FOR BID NO. RTS2-S-09**  
**2C7 : Special Construction Works**  
**SUPPLY AND CONSTRUCTION OF 115 KV BHUMIBOL SUBSTATION (GIS)**  
**TRANSMISSION SYSTEM EXPANSION AND RENOVATION PROJECT PHASE 2**

Item No.	Description	Drawing No. / Reference No.	Qty.	Unit	Local Currency (excluding VAT) Baht	
					Unit Price	Amount
2C7-1	Plate bearing test		6	set	20,000.00	120,000.00
2C7-2	Architectural and Civil engineering design work		Lump Sum	Lump Sum	19,517.72	19,517.72
<b>Total Price for Schedule 2C7</b>					<b>Baht</b>	<b>139,517.72</b>



นางสุตารัตน์ ไชยพันธุ์  
 ผู้อำนวยการฝ่ายวิศวกรรมระบบส่ง  
 31 Aug 2022



นางสาวอาสยา ช่างวิทยากร  
 หจกส-ท.  
 21 ก.ย. 2565

อนัน ชื่นชื่น  
นางสาวอาสยา ช่างวิทยากร  
หงตส-ท.  
21 ก.ย. 2565

**MEDIUM COST FOR BID NO. RTS2-S-09**  
**2D7 : Spare Parts for SF6 Gas Insulated Switchgear**  
**SUPPLY AND CONSTRUCTION OF 115 KV BHUMIBOL SUBSTATION (GIS)**  
**TRANSMISSION SYSTEM EXPANSION AND RENOVATION PROJECT PHASE 2**

Item No.	Description	Qty.	Unit	Currency	Supply of Equipment				Local Transportation	
					Foreign Supply		Local Supply		( excluding VAT ) Baht	
					CIF Thai Port		Ex-works Price ( excluding VAT ) Baht			
					Unit Price	Amount	Unit Price	Amount	Unit Price	Amount
2D7-1	Gas density meter with two-stage contacts for circuit breaker compartment spare parts for GIS	1	set	THB	30,711.00	30,711.00			XXXXX	XXXXX
2D7-2	Gas density meter for other compartment spare parts for GIS	1	set	THB	60,369.00	60,369.00			XXXXX	XXXXX
2D7-3	Rupture disc of overpressure protection device spare parts for GIS (1EA for each type/each operating pressure)	1	set	THB	23,751.00	23,751.00			XXXXX	XXXXX
2D7-4	Pump with motor for hydraulic spare parts for GIS (if any)	1	set	THB	53,397.00	53,397.00			XXXXX	XXXXX
2D7-5	Maintenance closing device for circuit breaker	1	set	THB	42,821.00	42,821.00			XXXXX	XXXXX
2D7-6	SF6 gas filling cart accessories for GIS	1	set	THB	193,656.00	193,656.00			XXXXX	XXXXX
2D7-7	Operating Analyzer Fitting Means accessories for GIS	1	set	THB	213,420.00	213,420.00			XXXXX	XXXXX
2D7-8	Hand pump for hydraulic accessories for GIS (if any)	1	set	THB	534,004.00	534,004.00			XXXXX	XXXXX
2D7-9	Cost of Local Transportation for Item No. 2D7-1 thru 2D7-8	Lump sum	Lump sum		XXXXXX	XXXXXX	XXXXXX	XXXXXX	86,409.68	86,409.68
				<b>THB</b>	<b>1,152,129.00</b>		<b>Baht</b>		<b>Baht</b>	
<b>Total Price for Schedule 2D7</b>									<b>86,409.68</b>	

นางสุดารัตน์ ไชยพันธุ์  
ผู้อำนวยการฝ่ายวิศวกรรมระบบส่ง

31 Aug 2022

นางสาวอาสยา ช่างวิทยากา  
 หจกต-ท.  
 21 ก.ย. 2565

**MEDIUM COST FOR BID NO. RTS2-S-09**  
**2D11 : Spare Parts for Power Fuse, Fuse Link and Hook Stick**  
**SUPPLY AND CONSTRUCTION OF 115 KV BHUMIBOL SUBSTATION (GIS)**  
**TRANSMISSION SYSTEM EXPANSION AND RENOVATION PROJECT PHASE 2**

Item No.	Description	Qty.	Unit	Currency	Supply of Equipment				Local Transportation	
					Foreign Supply		Local Supply		( excluding VAT ) Baht	
					CIF Thai Port		Ex-works Price			
					Unit Price	Amount	Unit Price	Amount	Unit Price	Amount
2D11-1	Fuse link or refill unit 40E for 22 kV power fuse (standard speed)	3		THB	12,764.40	38,293.20			XXXXX	XXXXX
2D11-2	Cost of Local Transportation for Item No. 2D11-1	Lump sum	Lump sum		XXXXX	XXXXX	XXXXX	XXXXX	2,871.99	2,871.99
				<b>THB</b>	<b>38,293.20</b>		<b>Baht</b>		<b>Baht</b>	
<b>Total Price for Schedule 2D11</b>									<b>2,871.99</b>	



นางสุดารัตน์ ไชยพันธุ์  
 ผู้อำนวยการฝ่ายวิศวกรรมระบบส่ง

31 Aug 2022

**MEDIUM COST FOR BID NO. RTS2-S-09**  
**2D37 : Spare Parts for Medium Voltage Switchgear**  
**SUPPLY AND CONSTRUCTION OF 115 KV BHUMIBOL SUBSTATION (GIS)**  
**TRANSMISSION SYSTEM EXPANSION AND RENOVATION PROJECT PHASE 2**

Item No.	Description	Qty.	Unit	Currency	Supply of Equipment				Local Transportation	
					Foreign Supply		Local Supply		( excluding VAT ) Baht	
					CIF Thai Port		Ex-works Price ( excluding VAT ) Baht			
					Unit Price	Amount	Unit Price	Amount	Unit Price	Amount
2D37-1	Gas density meter spare parts for medium voltage switchgear	1	set	THB	16,264.00	16,264.00			XXXXX	XXXXX
2D37-2	Pressure relief device spare parts for medium voltage switchgear (1EA for each type/each operating pressure)	1	set	THB	5,216.00	5,216.00			XXXXX	XXXXX
2D37-3	Gas refilling equipment with gas cylinder	1	set	THB	377,089.00	377,089.00			XXXXX	XXXXX
2D37-4	Cost of Local Transportation for Item No. 2D37-1 thru 2D37-3									
		Lump Sum	Lump Sum		XXXXX	XXXXX	XXXXX	XXXXX	29,892.68	29,892.68
<b>Total Price for Schedule 2D37</b>										
				<b>THB</b>	<b>398,569.00</b>		<b>Baht</b>		<b>Baht</b> <b>29,892.68</b>	

  
 นางสุดารัตน์ ไชยพันธุ์  
 ผู้อำนวยการฝ่ายวิศวกรรมระบบส่ง  
 31 Aug 2022

  
 นางสาวอาสยา ช่างวิทยากา  
 หจกส-ท.  
 21 ก.ย. 2565

อรน ชื่นชื่น  
นางสาวอัสยา ชาญวิทยาภา  
พจตส-ท.  
21 ก.ย. 2565

**MEDIUM COST FOR BID NO. RTS2-S-09**  
**2E24 : Control and Protection System**  
**SUPPLY AND CONSTRUCTION OF 115 KV BHUMIBOL SUBSTATION (GIS)**  
**TRANSMISSION SYSTEM EXPANSION AND RENOVATION PROJECT PHASE 2**

Item No.	Description	Drawing No. / Reference No.	Qty.	Unit	Currency	Supply of Equipment				Local Transportation		
						Foreign Supply		Local Supply		Local Transportation ( excluding VAT ) Baht		
						CIF Thai Port		Ex-works Price ( excluding VAT ) Baht				
						Unit Price	Amount	Unit Price	Amount	Unit Price	Amount	
2E24-1	Multi-function Protective IED (87L, 21BU, 67N, 50BF, 79, 25, 51S/51SG)	Supply as Loose Part for Installation at TE Substation - IED must be compatible with both Copper Wire (Having Binary Input, Binary Output and Analog Input) and IEC61850 Standard (4 Ports Ethernet for PRP) - Secondary Current Input Rating : 5A - Same Model Type as Supplied in Item 2AB24-2 (Primary Protection) - Have same connector type with Item No. 2E24-3 Specification Nos. 1002 and 1008	2	Ea					749,165	1,498,330.00	37,458	74,916.00

  
นางสุดารัตน์ ไชยพันธุ์  
ผู้อำนวยการฝ่ายวิศวกรรมระบบส่ง

31 Aug 2022



นางสาวอภิสยา ช่างวิทยากร  
 21 ก.ย. 2565

**MEDIUM COST FOR BID NO. RTS2-S-09**  
**2E24 : Control and Protection System**  
**SUPPLY AND CONSTRUCTION OF 115 KV BHUMIBOL SUBSTATION (GIS)**  
**TRANSMISSION SYSTEM EXPANSION AND RENOVATION PROJECT PHASE 2**

Item No.	Description	Drawing No. / Reference No.	Qty.	Unit	Currency	Supply of Equipment				Local Transportation		
						Foreign Supply		Local Supply		( excluding VAT ) Baht		
						CIF Thai Port		Ex-works Price				
						Unit Price	Amount	Unit Price	Amount	Unit Price	Amount	
2E24-2	Multi-function Protective IED (87L, 21BU, 67N, 50BF, 79, 25, 51S/51SG)	Supply as Loose Part for Installation at TA1 Substation - IED must be compatible with both Copper Wire (Having Binary Input, Binary Output and Analog Input) and IEC61850 Standard (4 Ports Ethernet for PRP) - Secondary Current Input Rating : 5A - Same Model Type as Supplied in Item 2AB24-2 (Primary Protection) - Have same connector type with Item No. 2E24-3 Specification Nos. 1002 and 1008	1	Ea					749,165	749,165.00	37,458	37,458.00

นางสุดารัตน์ ไชยพันธุ์  
 ผู้อำนวยการฝ่ายวิศวกรรมระบบส่ง

31 Aug 2022

**MEDIUM COST FOR BID NO. RTS2-S-09**  
**2E24 : Control and Protection System**  
**SUPPLY AND CONSTRUCTION OF 115 KV BHUMIBOL SUBSTATION (GIS)**  
**TRANSMISSION SYSTEM EXPANSION AND RENOVATION PROJECT PHASE 2**

Item No.	Description	Drawing No. / Reference No.	Qty.	Unit	Currency	Supply of Equipment				Local Transportation		
						Foreign Supply		Local Supply		( excluding VAT ) Baht		
						CIF Thai Port		Ex-works Price				
						Unit Price	Amount	Unit Price	Amount	Unit Price	Amount	
2E24-3	E1 CONVERTER	Supply for item 2E24-1 and 2E24-2 - This item include 2 sets of communication cable (for each E1) consists of 1 set of 30 m. multimode optic fiber patch cord cable and 1 set of 10 m. coaxial cable. - Have same connector type with Item No. 2E24-1 and 2E24-2 Specification No. SD-FOT-P22 Drawing No. TP-E-10.20	3	Ea					159,028	477,084.00	7,951	23,853.00
<b>Total Price for Schedule 2E24</b>									<b>Baht</b> 2,724,579.00		<b>Baht</b> 136,227.00	

นางสุดารัตน์ ไชยพันธุ์  
 ผู้อำนวยการฝ่ายวิศวกรรมระบบส่ง

31 Aug 2022

นางสาวอาสยา ช่างวิทยากร  
 หจคส-ท.

21 ก.ย. 2565

**MEDIUM COST FOR BID NO. RTS2-S-09**  
**3C7 : Special Construction Works**  
**SUPPLY AND CONSTRUCTION OF 230/115 KV BHUMIBOL SUBSTATION (GIS)**  
**FIRE PROTECTION SYSTEM PHASE 3**

Item No.	Description	Drawing No. / Reference No.	Qty.	Unit	Local Currency ( excluding VAT ) Baht	
					Unit Price	Amount
3C7-1	Test and commissioning for fire protection system in switchyard		Lump Sum	Lump Sum	100,000.00	100,000.00
3C7-2	Test and commissioning for inert gas system (Test in Electrical room)		Lump Sum	Lump Sum	78,000.00	78,000.00
3C7-3	Test and commissioning for foam-water spray system (for Transformer / Shunt reactor)		2	set	120,000.00	240,000.00
3C7-4	Test and commissioning for fire pump system		Lump Sum	Lump Sum	60,000.00	60,000.00
3C7-5	Test and commissioning for automatic water sprinkler system in GIS building		Lump Sum	Lump Sum	300,000.00	300,000.00
3C7-6	Fire Protection design work		Lump Sum	Lump Sum	643,956.55	643,956.55
<b>Total Price for Schedule 3C7</b>					<b>Baht 1,421,956.55</b>	

  
 นางสุดารัตน์ ไชยพันธุ์  
 ผู้อำนวยการฝ่ายวิศวกรรมระบบส่ง  
 31 Aug 2022

  
 นางสาวอัสยา ช่างวิทยากาฬ  
 หจคส-ท.  
 21 ก.ย. 2565

**MEDIUM COST FOR BID NO. RTS2-S-09**  
**3C9 : Fire Protection System**  
**SUPPLY AND CONSTRUCTION OF 230/115 KV BHUMIBOL SUBSTATION (GIS)**  
**FIRE PROTECTION SYSTEM PHASE 3**

Item No.	Description	Drawing No. / Reference No.	Qty.	Unit	Local Currency ( excluding VAT ) Baht	
					Unit Price	Amount
3C9-1	Fire Protection System for 230/115kV GIS Building	Designed by Contractor, See Dwg. No. BB-C-9, See Scope of work	Lump Sum	Lump Sum	28,100,000.00	28,100,000.00
3C9-2	Water storage tank min. capacity 250 cu.m	WD-UT-0-05 01/04-04/04	1	set	2,744,038.00	2,744,038.00
3C9-3	Foam house	SD-FH-8-01 01/07 to 07/07	1	set	997,832.00	997,832.00
3C9-4	Fire pump house	SD-FPH-8-01 01/01 to 09/09	1	set	1,496,748.00	1,496,748.00
3C9-5	Wheel fire extinguisher (2*50 lbs) with cabinet	HS-WR-0-04 - 01/01	3	set	255,695.00	767,085.00
3C9-6	Bladder tank proportioning system and components	Designed by Contractor	1	set	999,900.00	999,900.00
3C9-7	Fire Protection System for transformer / shunt reactor	Designed by Contractor	Lump Sum	Lump Sum	1,121,263.00	1,121,263.00

  
 นางสุตารัตน์ ไชยพันธุ์  
 ผู้อำนวยการฝ่ายวิศวกรรมระบบส่ง

31 Aug 2022

  
 นางสาวอาสยา ช่างวิทยากา  
 ทจตส-ท.  
 21 ก.ย. 2565

**MEDIUM COST FOR BID NO. RTS2-S-09**  
**3C9 : Fire Protection System**  
**SUPPLY AND CONSTRUCTION OF 230/115 KV BHUMIBOL SUBSTATION (GIS)**  
**FIRE PROTECTION SYSTEM PHASE 3**

Item No.	Description	Drawing No. / Reference No.	Qty.	Unit	Local Currency ( excluding VAT ) Baht	
					Unit Price	Amount
3C9-8	Fire Protection System for switchyard	Designed by Contractor, See Dwg. No. BB-C-9, See Scope of work	Lump Sum	Lump Sum	1,212,164.25	1,212,164.25
3C9-9	Fire Protection environmental monitoring system	Designed by Contractor	Lump Sum	Lump Sum	764,500.00	764,500.00
3C9-10	Fire pump system	Designed by Contractor	Lump Sum	Lump Sum	4,400,000.00	4,400,000.00
<b>Total Price for Schedule 3C9</b>					<b>Baht 42,603,530.25</b>	



นางสุตารัตน์ ไชยพันธุ์  
ผู้อำนวยการฝ่ายวิศวกรรมระบบส่ง

31 Aug 2022



นางสาวอัสยา ช่างวิทยากร  
ทจตส-ท.

21 ก.ย. 2565

**MEDIUM COST FOR BID NO. RTS2-S-09**  
**4AB18 : Low Voltage Cable and Conductor**  
**SUPPLY AND CONSTRUCTION FOR IMPROVEMENT OF 230 KV BHUMIBOL DAM POWER PLANT SWITCHYARD**  
**TRANSMISSION SYSTEM EXPANSION AND RENOVATION PROJECT PHASE 2**

Item No.	Description	Qty.	Unit	Currency	Supply of Equipment				Local Transportation, Construction and Installation (excluding VAT) Baht			
					Foreign Supply		Local Supply					
					CIF Thai Port		Ex-works Price (excluding VAT) Baht		Unit Price	Amount	Unit Price	Amount
					Unit Price	Amount	Unit Price	Amount				
4AB18-1	750 V power cable as per Specification attached	Lump sum	Lump sum				99,000.00	99,000.00	XXXXXX	XXXXXX		
4AB18-2	600 V control cable with PVC insulation as per Specification attached	Lump sum	Lump sum				1,550,780.00	1,550,780.00	XXXXXX	XXXXXX		
4AB18-3	Cost of Local Transportation, Construction and Installation for Item No. 4AB18-1 and 4AB18-2	Lump sum	Lump sum		XXXXXX	XXXXXX	XXXXXX	XXXXXX	412,445.00	412,445.00		
<b>Total Price for Schedule 4AB18</b>							<b>Baht</b>		<b>Baht</b>			
							<b>1,649,780.00</b>		<b>412,445.00</b>			

  
 นางสาวสุตารัตน์ ไชยพันธุ์  
 ผู้อำนวยการฝ่ายวิศวกรรมระบบส่ง  
 31 Aug 2022

  
 นางสาวอาสยา ช่างวิทยากาฬ  
 หจกส-ท.  
 21 ก.ย. 2565

**MEDIUM COST FOR BID NO. RTS2-S-09**  
**4AB24 : Control and Protection System**  
**SUPPLY AND CONSTRUCTION FOR IMPROVEMENT OF 230 KV BHUMIBOL DAM POWER PLANT SWITCHYARD**  
**TRANSMISSION SYSTEM EXPANSION AND RENOVATION PROJECT PHASE 2**

Item No.	Description	Drawing No. / Reference No.	Qty.	Unit	Currency	Supply of Equipment				Local Transportation, Construction and Installation (excluding VAT) Baht			
						Foreign Supply		Local Supply		Unit Price	Amount	Unit Price	Amount
						CIF Thai Port		Ex-works Price (excluding VAT) Baht					
						Unit Price	Amount	Unit Price	Amount	Unit Price	Amount		
4AB24-1	Multi-function Protective IED (87L, 21BU, 67N, 50BF, 79, 25, 51S/51SG)	Supply as Loose Part and Install in Existing Relay Panel Nos. 20R and 23R - IED must be compatible with both Copper Wire (Having Binary Input, Binary Output and Analog Input) and IEC61850 Standard (4 Ports Ethernet for PRP) - Secondary Current Input Rating : 5A - Same Model Type as Supplied in Item 1AB24-2 (Primary Protection) See Scope of Work Specification Nos. 1002 and 1008 Drawing Nos. BBPP-E-1, BBPP-E-2 sh.1-2 and BBPP-E-3	4	Ea					749,165	2,996,660.00	XXXXX	XXXXX	

  
 นางสุตารัตน์ ไชยพันธุ์  
 ผู้อำนวยการฝ่ายวิศวกรรมระบบส่ง  
 31 Aug 2022

  
 นางสาวอัสยา ช่างวิทยากร  
 หจก.ส.ท.  
 21 ก.ย. 2565

**MEDIUM COST FOR BID NO. RTS2-S-09**  
**4AB24 : Control and Protection System**  
**SUPPLY AND CONSTRUCTION FOR IMPROVEMENT OF 230 KV BHUMIBOL DAM POWER PLANT SWITCHYARD**  
**TRANSMISSION SYSTEM EXPANSION AND RENOVATION PROJECT PHASE 2**

Item No.	Description	Drawing No. / Reference No.	Qty.	Unit	Currency	Supply of Equipment				Local Transportation, Construction and Installation (excluding VAT) Baht			
						Foreign Supply		Local Supply		Unit Price	Amount	Unit Price	Amount
						CIF Thai Port		Ex-works Price (excluding VAT) Baht					
						Unit Price	Amount	Unit Price	Amount	Unit Price	Amount		
4AB24-2	MCB, 6A, 2 POLE FOR DC SUPPLY	Installed in Existing Relay Panel Nos. 20R and 23R Specification No.1002 See Scope of Work Drawing Nos. BBPP-E-1, BBPP-E-2 sh.1-2 and BBPP-E-3	5	Ea				4,015	20,075.00	XXXXXX	XXXXXX		
4AB24-3	TEST SWITCH (TS, for relays)	Installed in Existing Relay Panel Nos. 20R and 23R Specification No.1002 See Scope of Work Drawing Nos. BBPP-E-1, BBPP-E-2 sh.1-2 and BBPP-E-3	12	Ea				12,789	153,468.00	XXXXXX	XXXXXX		
4AB24-4	CUT OFF SWITCH, 10 CONTACTS (DTTCO, 87CO, 86ACO, 50/51SCO)	Installed in Existing Relay Panel Nos. 20R and 23R Specification No.1002 See Scope of Work Drawing Nos. BBPP-E-1, BBPP-E-2 sh.1-2 and BBPP-E-3	5	Ea				3,111	15,555.00	XXXXXX	XXXXXX		

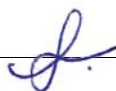
  
 นางสุดารัตน์ ไชยพันธุ์  
 ผู้อำนวยการฝ่ายวิศวกรรมระบบส่ง  
 31 Aug 2022



**MEDIUM COST FOR BID NO. RTS2-S-09**  
**4AB24 : Control and Protection System**  
**SUPPLY AND CONSTRUCTION FOR IMPROVEMENT OF 230 KV BHUMIBOL DAM POWER PLANT SWITCHYARD**  
**TRANSMISSION SYSTEM EXPANSION AND RENOVATION PROJECT PHASE 2**

Item No.	Description	Drawing No. / Reference No.	Qty.	Unit	Currency	Supply of Equipment				Local Transportation, Construction and Installation (excluding VAT) Baht			
						Foreign Supply		Local Supply					
						CIF Thai Port		Ex-works Price (excluding VAT) Baht		Unit Price	Amount	Unit Price	Amount
						Unit Price	Amount	Unit Price	Amount				
4AB24-5	DC UNDERVOLTAGE RELAY (27XB,27XR)	Installed in Existing Relay Panel Nos. 20R and 23R Specification No.1002 See Scope of Work Drawing Nos. BBPP-E-1, BBPP-E-2 sh.1-2 and BBPP-E-3	5	Ea				11,115	55,575.00	XXXXX	XXXXX		
4AB24-6	TRIPPING RELAY (94P, 94BU, 51X, 79X)	Installed in Existing Relay Panel Nos. 20R and 23R Specification No.1002 See Scope of Work Drawing Nos. BBPP-E-1, BBPP-E-2 sh.1-2 and BBPP-E-3	12	Ea				29,756	357,072.00	XXXXX	XXXXX		

  
 นางสาวรัตน์ ไชยพันธุ์  
 ผู้อำนวยการฝ่ายวิศวกรรมระบบส่ง  
 31 Aug 2022

  
 นางสาวอาสยา ช่างวิทยากร  
 ทจตส-ท.  
 21 ก.ย. 2565

**MEDIUM COST FOR BID NO. RTS2-S-09**  
**4AB24 : Control and Protection System**  
**SUPPLY AND CONSTRUCTION FOR IMPROVEMENT OF 230 KV BHUMIBOL DAM POWER PLANT SWITCHYARD**  
**TRANSMISSION SYSTEM EXPANSION AND RENOVATION PROJECT PHASE 2**

Item No.	Description	Drawing No. / Reference No.	Qty.	Unit	Currency	Supply of Equipment				Local Transportation, Construction and Installation (excluding VAT) Baht			
						Foreign Supply		Local Supply		Unit Price	Amount	Unit Price	Amount
						CIF Thai Port		Ex-works Price (excluding VAT) Baht					
						Unit Price	Amount	Unit Price	Amount	Unit Price	Amount		
4AB24-7	INDICATING LAMP (R,G,IL,LG)	(RED TYPE) Installed in Existing Relay Panel Nos. 20R and 23R Specification No.1002 See Scope of Work Drawing Nos. BBPP-E-1, BBPP-E-2 sh.1-2 and BBPP-E-3	4	Ea				501	2,004.00	XXXXX	XXXXX		
4AB24-8	E-1 CONVERTER PANEL	Panel No. E1 CONVERTER-1 Supply for item 4AB24-1 Specification No. 1008 See Scope of Work Drawing Nos. BBPP-E-1, BBPP-E-2 sh.1-2, BBPP-E-3, TP-E-10.20 and TP-E-20.3	1	Ea			903,445	903,445.00	XXXXX	XXXXX			

  
 นางสุตารัตน์ ไชยพันธุ์  
 ผู้อำนวยการฝ่ายวิศวกรรมระบบส่ง

31 Aug 2022

  
 นางสาวอสาชา ช่างวิทยากท  
 หจคส-ท.  
 21 ก.ย. 2565

**MEDIUM COST FOR BID NO. RTS2-S-09**  
**4AB24 : Control and Protection System**  
**SUPPLY AND CONSTRUCTION FOR IMPROVEMENT OF 230 KV BHUMIBOL DAM POWER PLANT SWITCHYARD**  
**TRANSMISSION SYSTEM EXPANSION AND RENOVATION PROJECT PHASE 2**

Item No.	Description	Drawing No. / Reference No.	Qty.	Unit	Currency	Supply of Equipment				Local Transportation, Construction and Installation (excluding VAT) Baht			
						Foreign Supply		Local Supply					
						CIF Thai Port		Ex-works Price (excluding VAT) Baht		Unit Price	Amount	Unit Price	Amount
						Unit Price	Amount	Unit Price	Amount				
4AB24-9	LOCKOUT RELAY (86, 10 contacts)	Installed in Existing Relay Panel No. 20R Specification No.1002 See Scope of Work Drawing Nos. BBPP-E-1, BBPP-E-2 sh.1-2 and BBPP-E-3	1	Ea				40,182	40,182.00	XXXXX	XXXXX		
4AB24-10	PUSH BUTTON	Installed in Existing Relay Panel No. 20R Specification No.1002 See Scope of Work Drawing Nos. BBPP-E-1, BBPP-E-2 sh.1-2 and BBPP-E-3	1	Ea			522	522.00	XXXXX	XXXXX			

  
 นางสุตารัตน์ ไชยพันธุ์  
 ผู้อำนวยการฝ่ายวิศวกรรมระบบส่ง  
 31 Aug 2022

  
 นางสาวอัสยา ช่างวิทยากร  
 ทจตส-ท.  
 21 ก.ย. 2565

**MEDIUM COST FOR BID NO. RTS2-S-09**  
**4AB24 : Control and Protection System**  
**SUPPLY AND CONSTRUCTION FOR IMPROVEMENT OF 230 KV BHUMIBOL DAM POWER PLANT SWITCHYARD**  
**TRANSMISSION SYSTEM EXPANSION AND RENOVATION PROJECT PHASE 2**

Item No.	Description	Drawing No. / Reference No.	Qty.	Unit	Currency	Supply of Equipment				Local Transportation, Construction and Installation (excluding VAT) Baht	
						Foreign Supply		Local Supply			
						CIF Thai Port		Ex-works Price (excluding VAT) Baht			
						Unit Price	Amount	Unit Price	Amount	Unit Price	Amount
4AB24-11	MODIFY TO THE EXISTING CONTROL AND PROTECTION SYSTEM	See Scope of Work, Drawing Nos. BBPP-E-1, BBPP-E-2 sh.1-2 and BBPP-E-3	1	SET		XXXXX	XXXXX	XXXXX	XXXXX	167,302	167,302.00
4AB24-12	Cost of Local Transportation, Construction and Installation for Item No.4AB24-1 thru 4AB24-10		Lump sum	Lump sum		XXXXX	XXXXX	XXXXX	XXXXX	454,430.98	454,430.98
<b>Total Price for Schedule 4AB24</b>								<b>Baht</b>		<b>Baht</b>	
								<b>4,544,558.00</b>		<b>621,732.98</b>	



นางสุดารัตน์ ไชยพันธุ์  
 ผู้อำนวยการฝ่ายวิศวกรรมระบบส่ง

31 Aug 2022

นางสาวอัสยา

นางสาวอัสยา ช่างวิทยากร  
 หจกส-ท.

21 ก.ย. 2565

**MEDIUM COST FOR BID NO. RTS2-S-09**

**4AB25 : Fault Recording System**

**SUPPLY AND CONSTRUCTION FOR IMPROVEMENT OF 230 KV BHUMIBOL DAM POWER PLANT SWITCHYARD  
TRANSMISSION SYSTEM EXPANSION AND RENOVATION PROJECT PHASE 2**

Item No.	Description	Drawing No. / Reference No.	Qty.	Unit	Currency	Supply of Equipment				Local Transportation, Construction and Installation (excluding VAT) Baht			
						Foreign Supply		Local Supply					
						CIF Thai Port		Ex-works Price (excluding VAT) Baht		Unit Price	Amount	Unit Price	Amount
						Unit Price	Amount	Unit Price	Amount				
4AB25-1	MODIFICATION TO THE EXISTING FAULT RECORDING SYSTEM	See Scope of Work, Drawing Nos. BBPP-E-1, BBPP-E-2 sh.1-2 and BBPP-E-3	1	SET		XXXXX	XXXXX	XXXXX	XXXXX	36,814.16	36,814.16		
<b>Total Price for Schedule 4AB25</b>									<b>Baht</b>	<b>Baht</b>	<b>36,814.16</b>		



นางสุดารัตน์ ไชยพันธุ์  
ผู้อำนวยการฝ่ายวิศวกรรมระบบส่ง

31 Aug 2022



นางสาวอาสยา ช่างวิทยากา  
ทจตส-ท.

21 ก.ย. 2565

  
 นางสาวอัสยา ช่างวิทยากร  
 พจตส-ท.  
 21 ก.ย. 2565

**MEDIUM COST FOR BID NO. RTS2-S-09**

**4AB35 : Communication Cable**

**SUPPLY AND CONSTRUCTION FOR IMPROVEMENT OF 230 KV BHUMIBOL DAM POWER PLANT SWITCHYARD**

**TRANSMISSION SYSTEM EXPANSION AND RENOVATION PROJECT PHASE 2**

Item No.	Description	Qty.	Unit	Currency	Supply of Equipment				Local Transportation, Construction and Installation (excluding VAT) Baht			
					Foreign Supply		Local Supply		Unit Price	Amount	Unit Price	Amount
					CIF Thai Port		Ex-works Price (excluding VAT) Baht					
					Unit Price	Amount	Unit Price	Amount	Unit Price	Amount		
4AB35-1	<b>Optical fiber cable from joint box at Bhumibol Substation Line No.1 take-off structure to fiber frame termination cabinet at Bhumibol Hydro Power Plant control room</b>											
4AB35-1.1	Supply of optical fiber cable and accessories including: (a) 36-core non-metallic optical fiber cable (approx. 500 meters) (b) Rigid steel conduit from take-off structure to cable trench (lump sum) (c) EFLEX and/or HDPE conduit with hot-dip galvanized steel clamp (lump sum) (d) Fiber frame termination cabinet with cable tray (Bhumibol Hydro Power Plant control room - 1 set) (e) 36 pigtailed (1.5 meter) (Bhumibol Hydro Power Plant control room - 1 set) (f) 6-wire cleat for coiling optical fiber cable at take-off structure (4 sets)	1	LOT					133,910.00	133,910.00	XXXXX	XXXXX	
4AB35-1.2	Local transportation, Construction and Installation for item 4AB35-1.1 (Including splicing work and field testing for optical fiber)	1	JOB		XXXXX	XXXXX	XXXXX	XXXXX	XXXXX	243,790.00	243,790.00	

  
 นางสุตารัตน์ ไชยพันธุ์  
 ผู้อำนวยการฝ่ายวิศวกรรมระบบส่ง  
 31 Aug 2022

**MEDIUM COST FOR BID NO. RTS2-S-09**

**4AB35 : Communication Cable**

**SUPPLY AND CONSTRUCTION FOR IMPROVEMENT OF 230 KV BHUMIBOL DAM POWER PLANT SWITCHYARD**

**TRANSMISSION SYSTEM EXPANSION AND RENOVATION PROJECT PHASE 2**

Item No.	Description	Qty.	Unit	Currency	Supply of Equipment				Local Transportation, Construction and Installation (excluding VAT) Baht			
					Foreign Supply		Local Supply					
					CIF Thai Port		Ex-works Price (excluding VAT) Baht		Unit Price	Amount	Unit Price	Amount
					Unit Price	Amount	Unit Price	Amount				
4AB35-2	<b>Optical fiber cable from joint box at Bhumibol Substation Line No.2 take-off structure to fiber frame termination cabinet at Bhumibol Hydro Power Plant control room</b>											
4AB35-2.1	Supply of optical fiber cable and accessories including: (a) 36-core non-metallic optical fiber cable (approx. 500 meters) (b) Rigid steel conduit from take-off structure to cable trench (lump sum) (c) EFLEX and/or HDPE conduit with hot-dip galvanized steel clamp (lump sum) (d) Fiber frame termination cabinet with cable tray (Bhumibol Hydro Power Plant control room - 1 set) (e) 36 pigtailed (1.5 meter) (Bhumibol Hydro Power Plant control room - 1 set) (f) 6-wire cleat for coiling optical fiber cable at take-off structure (4 sets)	1	LOT				133,910.00	133,910.00	XXXXX	XXXXX		

  
 นางสุดารัตน์ ไชยพันธุ์  
 ผู้อำนวยการฝ่ายวิศวกรรมระบบส่ง  
 31 Aug 2022

อวส. ชิงฉิมพาร  
 นางสาวอาสยา ช่างวิทยากา  
 หจกส-ท.  
 21 ก.ย. 2565

**MEDIUM COST FOR BID NO. RTS2-S-09**  
**4AB35 : Communication Cable**  
**SUPPLY AND CONSTRUCTION FOR IMPROVEMENT OF 230 KV BHUMIBOL DAM POWER PLANT SWITCHYARD**  
**TRANSMISSION SYSTEM EXPANSION AND RENOVATION PROJECT PHASE 2**

Item No.	Description	Qty.	Unit	Currency	Supply of Equipment				Local Transportation, Construction and Installation ( excluding VAT ) Baht	
					Foreign Supply		Local Supply			
					CIF Thai Port		Ex-works Price ( excluding VAT ) Baht			
					Unit Price	Amount	Unit Price	Amount	Unit Price	Amount
4AB35-2.2	Local transportation, Construction and Installation for item 4AB35-2.1 (Including splicing work and field testing for optical fiber)	1	JOB		XXXXX	XXXXX	XXXXX	XXXXX	243,790.00	243,790.00
	IMPORTANT: 1. Telecommunication Equipment supplied under Schedule AB35 shall conform to Telecommunication Equipment Specification: Single Sheath Non-metallic Optical Fiber Cable (SD-FOT-P22). 2. The Bidder is required to later break down the unit price for sub-items of this Schedule for consideration.									
<b>Total Price for Schedule 4AB35</b>								<b>Baht</b> <b>267,820.00</b>	<b>Baht</b> <b>487,580.00</b>	

  
 นางสาวสุตารัตน์ ไชยพันธุ์  
 ผู้อำนวยการฝ่ายวิศวกรรมระบบส่ง  
 31 Aug 2022

  
 นางสาวอัสยา ช่างวิทยากร  
 หจกส-ท.  
 21 ก.ย. 2565



**MEDIUM COST FOR BID NO. RTS2-S-09**

**4AB38 : Remote Terminal Unit**

**SUPPLY AND CONSTRUCTION FOR IMPROVEMENT OF 230 KV BHUMIBOL DAM POWER PLANT SWITCHYARD  
TRANSMISSION SYSTEM EXPANSION AND RENOVATION PROJECT PHASE 2**

Item No.	Description	Drawing No. / Reference No.	Qty.	Unit	Currency	Supply of Equipment				Local Transportation, Construction and Installation (excluding VAT) Baht			
						Foreign Supply		Local Supply		Ex-works Price (excluding VAT) Baht		Unit Price	Amount
						CIF Thai Port							
						Unit Price	Amount	Unit Price	Amount	Unit Price	Amount		
4AB38-1	DIGITAL INPUT MODULE OF EGAT RTU	Installed in Existing EGAT RTU Cabinet Drawing Nos. BBPP-E-1, BBPP-E-2 sh.1-2 and BBPP-E-3	5	Ea		Supplied by EGAT	Supplied by EGAT	Supplied by EGAT	Supplied by EGAT	XXXXX	XXXXX		
4AB38-2	MODIFICATION TO THE EXISTING REMOTE TERMINAL UNIT	See Scope of Work, Drawing Nos. BBPP-E-1, BBPP-E-2 sh.1-2 and BBPP-E-3	1	SET		XXXXX	XXXXX	XXXXX	XXXXX	84,749	84,749.00		
4AB38-3	Cost of Local Transportation, Construction and Installation for Item No.4AB38-1		Lump sum	Lump sum		XXXXX	XXXXX	XXXXX	XXXXX	14,375	14,375.00		
<b>Total Price for Schedule 4AB38</b>								<b>Baht</b>		<b>Baht</b>	<b>99,124.00</b>		



นางสุดารัตน์ ไชยพันธุ์  
ผู้อำนวยการฝ่ายวิศวกรรมระบบส่ง

31 Aug 2022



นางสาวอัสยา ช่างวิทยากา  
ทจตส-ท.

21 ก.ย. 2565

**MEDIUM COST FOR BID NO. RTS2-S-09**  
**4D24 : Spare Parts for Control and Protection System**  
**SUPPLY AND CONSTRUCTION FOR IMPROVEMENT OF 230 KV BHUMIBOL DAM POWER PLANT SWITCHYARD**  
**TRANSMISSION SYSTEM EXPANSION AND RENOVATION PROJECT PHASE 2**

Item No.	Description	Drawing No. / Reference No.	Qty.	Unit	Currency	Supply of Equipment				Local Transportation ( excluding VAT ) Baht			
						Foreign Supply		Local Supply					
						CIF Thai Port		Ex-works Price ( excluding VAT ) Baht		Unit Price	Amount	Unit Price	Amount
						Unit Price	Amount	Unit Price	Amount				
4D24-1	Multi-function Protective IED (87L, 21BU, 67N, 50BF, 79, 25, 51S/51SG)	Supply as Spare Part - IED must be compatible with both Copper Wire (Having Binary Input, Binary Output and Analog Input) and IEC61850 Standard (4 Ports Ethernet for PRP) - Secondary Current Input Rating : 5A - Same Model Type as Supplied in Item 4AB24-1 (Primary Protection) Specification Nos. 1002 and 1008	1	Ea				749,165	749,165.00	37,458	37,458.00		

  
 นางสาวดารัตน์ ไชยพันธุ์  
 ผู้อำนวยการฝ่ายวิศวกรรมระบบส่ง  
 31 Aug 2022

  
 นางสาวอาสยา ช่างวิทยากา  
 หจตส-ท.  
 21 ก.ย. 2565

**MEDIUM COST FOR BID NO. RTS2-S-09**  
**4D24 : Spare Parts for Control and Protection System**  
**SUPPLY AND CONSTRUCTION FOR IMPROVEMENT OF 230 KV BHUMIBOL DAM POWER PLANT SWITCHYARD**  
**TRANSMISSION SYSTEM EXPANSION AND RENOVATION PROJECT PHASE 2**

Item No.	Description	Drawing No. / Reference No.	Qty.	Unit	Currency	Supply of Equipment				Local Transportation (excluding VAT) Baht			
						Foreign Supply		Local Supply					
						CIF Thai Port		Ex-works Price (excluding VAT) Baht		Unit Price		Amount	
						Unit Price	Amount	Unit Price	Amount				
4D24-2	Multi-function Protective IED (87L, 21BU, 67N, 50BF, 79, 25, 51S/51SG)	Supply as Spare Part - IED must be compatible with both Copper Wire (Having Binary Input, Binary Output and Analog Input) and IEC61850 Standard (4 Ports Ethernet for PRP) - Secondary Current Input Rating : 5A - Same Model Type as Supplied in Item 4AB24-1 (Secondary Protection) Specification Nos. 1002 and 1008	1	Ea					749,165	749,165.00	37,458	37,458.00	
<b>Total Price for Schedule 4D24</b>									<b>Baht 1,498,330.00</b>		<b>Baht 74,916.00</b>		

  
 นางสาวสุตารัตน์ ไชยพันธุ์  
 ผู้อำนวยการฝ่ายวิศวกรรมระบบส่ง  
 31 Aug 2022

  
 นางสาวอาสยา ช่างวิทยากา  
 หจกส.ท.  
 21 ก.ย. 2565

**MEDIUM COST FOR BID NO. RTS2-S-09**  
**5AB18 : Low Voltage Cable and Conductor**  
**SUPPLY AND CONSTRUCTION FOR IMPROVEMENT OF 230 KV TAK 2 SUBSTATION**  
**TRANSMISSION SYSTEM EXPANSION AND RENOVATION PROJECT PHASE 2**

Item No.	Description	Qty.	Unit	Currency	Supply of Equipment				Local Transportation, Construction and Installation (excluding VAT) Baht			
					Foreign Supply		Local Supply		Unit Price	Amount	Unit Price	Amount
					CIF Thai Port		Ex-works Price (excluding VAT) Baht					
					Unit Price	Amount	Unit Price	Amount	Unit Price	Amount		
5AB18-1	750 V power cable as per Specification attached	Lump sum	Lump sum				33,000.00	33,000.00	XXXXX	XXXXX		
5AB18-2	600 V control cable with PVC insulation as per Specification attached	Lump sum	Lump sum				629,970.00	629,970.00	XXXXX	XXXXX		
5AB18-3	Cost of Local Transportation, Construction and Installation for Item No. 5AB18-1 and 5AB18-2	Lump sum	Lump sum		XXXXX	XXXXX	XXXXX	XXXXX	165,742.50	165,742.50		
<b>Total Price for Schedule 5AB18</b>							<b>Baht 662,970.00</b>		<b>Baht 165,742.50</b>			

  
 นางสุตารัตน์ ไชยพันธุ์  
 ผู้อำนวยการฝ่ายวิศวกรรมระบบส่ง  
 31 Aug 2022

  
 นางสาวอัสยา ช่างวิทยากา  
 หจคส-ท.  
 21 ก.ย. 2565

อรุณ ชินฉันทานนท์  
นางสาวอาสยา ช่างวิทยากร  
หงตส-น.  
21 ก.ย. 2565

**MEDIUM COST FOR BID NO. RTS2-S-09**  
**5AB24 : Control and Protection System**  
**SUPPLY AND CONSTRUCTION FOR IMPROVEMENT OF 230 KV TAK 2 SUBSTATION**  
**TRANSMISSION SYSTEM EXPANSION AND RENOVATION PROJECT PHASE 2**

Item No.	Description	Drawing No. / Reference No.	Qty.	Unit	Currency	Supply of Equipment				Local Transportation, Construction and Installation (excluding VAT) Baht			
						Foreign Supply		Local Supply		Unit Price	Amount	Unit Price	Amount
						CIF Thai Port		Ex-works Price (excluding VAT) Baht					
						Unit Price	Amount	Unit Price	Amount	Unit Price	Amount		
5AB24-1	Multi-function Protective IED (87L, 21BU, 67N, 50BF, 79, 25, 51S/51SG)	Supply as Loose Part and Install in Existing Relay Panel No. 1R - IED must be compatible with both Copper Wire (Having Binary Input, Binary Output and Analog Input) and IEC61850 Standard (4 Ports Ethernet for PRP) - Secondary Current Input Rating : 5A - Same Model Type as Supplied in Item 1AB24-2 (Primary Protection) Specification Nos. 1002 and 1008 See Scope of Work Drawing Nos.TA2-E-1.2, TA2-E-2.1 and TA2-E-3	1	Ea				749,165	749,165.00	XXXXX	XXXXX		
5AB24-2	MCB, 6A, 2 POLE FOR DC SUPPLY	Installed in Existing Relay Panel No. 1R Specification No.1002 See Scope of Work Drawing Nos.TA2-E-1.2, TA2-E-2.1 and TA2-E-3	1	Ea				4,015	4,015.00	XXXXX	XXXXX		

นางสุดารัตน์ ไชยพันธุ์  
ผู้อำนวยการฝ่ายวิศวกรรมระบบส่ง

31 Aug 2022

**MEDIUM COST FOR BID NO. RTS2-S-09**  
**5AB24 : Control and Protection System**  
**SUPPLY AND CONSTRUCTION FOR IMPROVEMENT OF 230 KV TAK 2 SUBSTATION**  
**TRANSMISSION SYSTEM EXPANSION AND RENOVATION PROJECT PHASE 2**

Item No.	Description	Drawing No. / Reference No.	Qty.	Unit	Currency	Supply of Equipment				Local Transportation, Construction and Installation (excluding VAT) Baht			
						Foreign Supply		Local Supply					
						CIF Thai Port		Ex-works Price (excluding VAT) Baht		Unit Price	Amount	Unit Price	Amount
						Unit Price	Amount	Unit Price	Amount				
5AB24-3	TEST SWITCH (TS, for relays)	Installed in Existing Relay Panel No. 1R Specification No.1002 See Scope of Work Drawing Nos.TA2-E-1.2, TA2-E-2.1 and TA2-E-3	2	Ea				12,789	25,578.00	XXXXX	XXXXX		
5AB24-4	CUT OFF SWITCH, 10 CONTACTS (DTTCO, 87CO, 86ACO, 50/51SCO)	Installed in Existing Relay Panel No. 1R Specification No.1002 See Scope of Work Drawing Nos.TA2-E-1.2, TA2-E-2.1 and TA2-E-3	2	Ea				3,111	6,222.00	XXXXX	XXXXX		



นางสุดารัตน์ ไชยพันธุ์  
 ผู้อำนวยการฝ่ายวิศวกรรมระบบส่ง

31 Aug 2022



นางสาวอัสยา ช่างวิทยากา  
 หจกส.ท.

21 ก.ย. 2565

**MEDIUM COST FOR BID NO. RTS2-S-09**  
**5AB24 : Control and Protection System**  
**SUPPLY AND CONSTRUCTION FOR IMPROVEMENT OF 230 KV TAK 2 SUBSTATION**  
**TRANSMISSION SYSTEM EXPANSION AND RENOVATION PROJECT PHASE 2**

Item No.	Description	Drawing No. / Reference No.	Qty.	Unit	Currency	Supply of Equipment				Local Transportation, Construction and Installation (excluding VAT) Baht			
						Foreign Supply		Local Supply		Unit Price	Amount	Unit Price	Amount
						CIF Thai Port		Ex-works Price (excluding VAT) Baht					
						Unit Price	Amount	Unit Price	Amount	Unit Price	Amount		
5AB24-5	DC UNDERVOLTAGE RELAY (27XB,27XR)	Installed in Existing Relay Panel Nos. 1R and Existing Interposing Panel Specification No.1002 See Scope of Work Drawing Nos.TA2-E-1.2, TA2-E-2.1 and TA2-E-3	3	Ea				11,115	33,345.00	XXXXXX	XXXXXX		
5AB24-6	TRIPPING RELAY (94P, 94BU, 51X, 79X)	Installed in Existing Relay Panel No. 1R Specification No.1002 See Scope of Work Drawing Nos.TA2-E-1.2, TA2-E-2.1 and TA2-E-3	1	Ea				29,756	29,756.00	XXXXXX	XXXXXX		
5AB24-7	INDICATING LAMP (R,G,IL,LG)	(RED TYPE) Installed in Existing Relay Panel No. 1R Specification No.1002 See Scope of Work Drawing Nos.TA2-E-1.2, TA2-E-2.1 and TA2-E-3	2	Ea				501	1,002.00	XXXXXX	XXXXXX		

  
 นางสุดารัตน์ ไชยพันธ์  
 ผู้อำนวยการฝ่ายวิศวกรรมระบบส่ง

31 Aug 2022

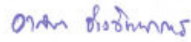
  
 นางสาวอาสยา ช่างวิทยากา  
 หจดส-ท.  
 21 ก.ย. 2565

**MEDIUM COST FOR BID NO. RTS2-S-09**  
**5AB24 : Control and Protection System**  
**SUPPLY AND CONSTRUCTION FOR IMPROVEMENT OF 230 KV TAK 2 SUBSTATION**  
**TRANSMISSION SYSTEM EXPANSION AND RENOVATION PROJECT PHASE 2**

Item No.	Description	Drawing No. / Reference No.	Qty.	Unit	Currency	Supply of Equipment				Local Transportation, Construction and Installation (excluding VAT) Baht			
						Foreign Supply		Local Supply		Unit Price	Amount	Unit Price	Amount
						CIF Thai Port		Ex-works Price (excluding VAT) Baht					
						Unit Price	Amount	Unit Price	Amount	Unit Price	Amount		
5AB24-8	E1 CONVERTER	Supply for item 5AB24-1 and Installed in Existing Panel. Specification No. SD-FOT-P22 See Scope of Work Drawing Nos.TA2-E-1.2, TA2-E-2.1, TA2-E-3 and TP-E-10.20	1	Ea				159,028	159,028.00	XXXXX	XXXXX		
5AB24-9	INTERPOSING RELAY (CCX,CTX)	Installed in Existing Interposing Relay Panel Specification No.1002 See Scope of Work Drawing Nos.TA2-E-1.2, TA2-E-2.1 and TA2-E-3	2	Ea			3,894	7,788.00	XXXXX	XXXXX			



นางสุดารัตน์ ไชยพันธุ์  
 ผู้อำนวยการฝ่ายวิศวกรรมระบบส่ง

31 Aug 2022

นางสาวอัสยา ช่างวิทยากา

ทจตส-ท.

ทจตส-ท.

21 ก.ย. 2565



**MEDIUM COST FOR BID NO. RTS2-S-09**  
**5AB24 : Control and Protection System**  
**SUPPLY AND CONSTRUCTION FOR IMPROVEMENT OF 230 KV TAK 2 SUBSTATION**  
**TRANSMISSION SYSTEM EXPANSION AND RENOVATION PROJECT PHASE 2**

Item No.	Description	Drawing No. / Reference No.	Qty.	Unit	Currency	Supply of Equipment				Local Transportation, Construction and Installation (excluding VAT) Baht	
						Foreign Supply		Local Supply			
						CIF Thai Port		Ex-works Price (excluding VAT) Baht			
						Unit Price	Amount	Unit Price	Amount	Unit Price	Amount
5AB24-10	MODIFICATION TO THE EXISTING CONTROL AND PROTECTION SYSTEM	See Scope of Work, Drawing Nos.TA2-E-1.2, TA2-E-2.1 and TA2-E-3	1	Ea		XXXXX	XXXXX	XXXXX	XXXXX	53,012	53,012.00
5AB24-11	Cost of Local Transportation, Construction and Installation for Item No.5AB24-1 thru 5AB24-9		Lump sum	Lump sum		XXXXX	XXXXX	XXXXX	XXXXX	101,589.90	101,589.90
<b>Total Price for Schedule 5AB24</b>									<b>Baht</b>	<b>1,015,899.00</b>	<b>Baht</b> <b>154,601.90</b>

  
 นางสาวสุดารัตน์ ไชยพันธุ์  
 ผู้อำนวยการฝ่ายวิศวกรรมระบบส่ง  
 31 Aug 2022

  
 นางสาวอาสยา ช่างวิทยากา  
 หจกส-ท.  
 21 ก.ย. 2565

**MEDIUM COST FOR BID NO. RTS2-S-09**  
**5AB25 : Fault Recording System**  
**SUPPLY AND CONSTRUCTION FOR IMPROVEMENT OF 230 KV TAK 2 SUBSTATION**  
**TRANSMISSION SYSTEM EXPANSION AND RENOVATION PROJECT PHASE 2**

Item No.	Description	Drawing No. / Reference No.	Qty.	Unit	Currency	Supply of Equipment				Local Transportation, Construction and Installation (excluding VAT) Baht			
						Foreign Supply		Local Supply					
						CIF Thai Port		Ex-works Price (excluding VAT) Baht		Unit Price	Amount	Unit Price	Amount
						Unit Price	Amount	Unit Price	Amount				
5AB25-1	MODIFICATION TO THE EXISTING FAULT RECORDING SYSTEM	See Scope of Work, Drawing Nos.TA2-E-1.2, TA2-E-2.1 and TA2-E-3	1	SET		XXXXX	XXXXX	XXXXX	XXXXX	14,726	14,726.00		
<b>Total Price for Schedule 5AB25</b>								<b>Baht</b>		<b>Baht</b> <b>14,726.00</b>			

  
 นางสุดารัตน์ ไชยพันธุ์  
 ผู้อำนวยการฝ่ายวิศวกรรมระบบส่ง  
 31 Aug 2022

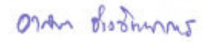
  
 นางสาวอัสยา ช่างวิทยากา  
 หจกส-ท.  
 21 ก.ย. 2565

**MEDIUM COST FOR BID NO. RTS2-S-09**

**5AB38 : Remote Terminal Unit**

**SUPPLY AND CONSTRUCTION FOR IMPROVEMENT OF 230 KV TAK 2 SUBSTATION**

**TRANSMISSION SYSTEM EXPANSION AND RENOVATION PROJECT PHASE 2**

Item No.	Description	Drawing No. / Reference No.	Qty.	Unit	Currency	Supply of Equipment				Local Transportation, Construction and Installation (excluding VAT) Baht	
						Foreign Supply		Local Supply			
						CIF Thai Port		Ex-works Price (excluding VAT) Baht			
						Unit Price	Amount	Unit Price	Amount	Unit Price	Amount
5AB38-1	MODIFICATION TO THE EXISTING REMOTE TERMINAL UNIT	See Scope of Work, Drawing Nos.TA2-E-1.2, TA2-E-2.1 and TA2-E-3	1	SET		XXXXX	XXXXX	XXXXXX	XXXXXX	22,599.61	22,599.61
<b>Total Price for Schedule 5AB38</b>								<b>Baht</b>		<b>Baht</b> <b>22,599.61</b>	



นางสุตารัตน์ ไชยพันธุ์  
ผู้อำนวยการฝ่ายวิศวกรรมระบบส่ง

31 Aug 2022

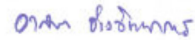

นางสาวอาสยา ช่างวิทยากร  
ทงตล-ท.

21 ก.ย. 2565

**MEDIUM COST FOR BID NO. RTS2-S-09**  
**5D24 : Spare Parts for Control and Protection System**  
**SUPPLY AND CONSTRUCTION FOR IMPROVEMENT OF 230 KV TAK 2 SUBSTATION**  
**TRANSMISSION SYSTEM EXPANSION AND RENOVATION PROJECT PHASE 2**

Item No.	Description	Drawing No. / Reference No.	Qty.	Unit	Currency	Supply of Equipment				Local Transportation ( excluding VAT ) Baht			
						Foreign Supply		Local Supply					
						CIF Thai Port		Ex-works Price ( excluding VAT ) Baht		Unit Price	Amount	Unit Price	Amount
						Unit Price	Amount	Unit Price	Amount				
5D24-1	Multi-function Protective IED (87L, 21BU, 67N, 50BF, 79, 25, 51S/51SG)	Supply as Spare Part - IED must be compatible with both Copper Wire (Having Binary Input, Binary Output and Analog Input) and IEC61850 Standard (4 Ports Ethernet for PRP) - Secondary Current Input Rating : 5A - Same Model Type as Supplied in Item 5AB24-1 (Primary Protection) Specification Nos. 1002 and 1008	1	Ea				749,165	749,165.00	37,458	37,458.00		
<b>Total Price for Schedule 5D24</b>								<b>Baht 749,165.00</b>		<b>Baht 37,458.00</b>			

  
 นางสุตารัตน์ ไชยพันธุ์  
 ผู้อำนวยการฝ่ายวิศวกรรมระบบส่ง  
 31 Aug 2022

  
 นางสาวอาสยา ช่างวิทยากา  
 หจตส-ท.  
 21 ก.ย. 2565

**Important Information**  
**for**  
**Invitation to Bid No. RTS2-S-09**

---

The purpose of this section is to inform the Bidders to **carefully study** the details of the revised terms and conditions in the bidding documents. The following provisions have been **recently revised** as stated hereunder:

**Article A-3. Eligibility of Bidders: General Requirements and Article B-8. Information to be Submitted with Bid**

Bidders shall provide written anti-corruption policies and guidelines as specified in Data Sheet.

**Article E-16. Inspection and Tests**

Terms and conditions regarding inspection and tests have been revised.

**Article F-8. Drawings and Documents to be Furnished by the Contractor**

Terms and conditions regarding EGAT's document management system in item a. have been added. The number of copies of the drawings and documents in Print and CD-ROM has been revised and Item c. Reproducible Drawings has been deleted.

Details in Drawings and Documents Required for Each Particular Equipment at the end of section F have been revised.

**Article F-15. Liquidated Damages for Late Completion and Late Delivery**

The total amount of liquidated damages shall not exceed ten (10) per cent of the total Contract Price, thereafter EGAT shall have the right, at its sole discretion, to terminate the Contract.

**Article F-18. Maintenance Guarantee and Article F-19. Maintenance Security**

In case all obligations on the part of the Contractor for the work under separated guarantee period under the Contract have been fulfilled, the Contractor is entitled to request EGAT to return the maintenance security guaranteed for such work regardless of the non-issuance of the Final Acceptance Certificate.

**Article G-5. Safety of Personnel and Third Parties and Prevention of Accidents**

Safety terms and conditions have been revised. The Contractor shall observe and comply with the revised terms and conditions including Table 1. Safety Criteria and Conditions, Table 2. Contractor's Safety Information, and Table 3. Contractor Safety Evaluation Checklist which have been added at the end of Section G.

# DATA SHEET

for

## Invitation to Bid No. RTS2-S-09

(Two-envelope)

---

This Section consists of provisions that are specific to each procurement and supplement the information or requirements included in Bidding Documents.

### **Article A-3. Eligibility of Bidders: General Requirements**

The following requirement shall be added to item I:

*“j. Bidders shall provide written anti-corruption policies and guidelines with respect to procurement and supplies according to the Notification of the Anti-Corruption Co-Operation Committee Concerning Minimum Standards of the Anti-Corruption Policies and Guidelines in Relation to Procurement and Supplies Required to be Implemented by the Business Operator, Section 19 of the Government Procurement and Supplies Management Act B.E. 2560 (A.D. 2017).”*

### **Article B-3. Bid Security**

The amount of bid security shall be USD 1,417,920.- or THB 52,250,000.-.

### **Article B-4. Validity of Bids**

The validity of the bid shall be for three hundred (300) Days from the date specified for opening of technical proposals.

### **Article B-8. Information to be Submitted with Bid**

The following document shall be added to Article B-8. Information to be Submitted with Bid:

*s. Bidder’s anti-corruption policies and guidelines in relation to procurement and supplies together with the completely filled out Anti-Corruption Compliance Checklist as provided.*

**Article F-15. Liquidated Damages for Late Completion and Late Delivery, item a. For Complete Construction of Substation,**

If the Contractor fails to meet any of the completion dates for Schedule 1 : 230 kV Bhumibol Substation (GIS) or Schedule 2 : 115 kV Bhumibol Substation (GIS) or Schedule 3 : 230/115 kV Bhumibol Substation (GIS) (Fire Protection System Phase 3) or Schedule 4 : 230 kV Bhumibol Dam Power Plant Switchyard or Schedule 5 : 230 kV Tak 2 Substation, the liquidated damages shall be at the rate of one-tenth of one (0.10) per cent of the total Contract Price for Schedule 1 : 230 kV Bhumibol Substation (GIS) and Schedule 2 : 115 kV Bhumibol Substation (GIS) and Schedule 3 : 230/115 kV Bhumibol Substation (GIS) (Fire Protection System Phase 3) and Schedule 4 : 230 kV Bhumibol Dam Power Plant Switchyard and Schedule 5 : 230 kV Tak 2 Substation for each Day of delay. This sum is payable regardless of the actual loss and/or damages incurred.

**Maintenance Guarantee Period**

- For all Work except 500 kV System

The Contractor shall guarantee the proper functioning of the Work for a period of one (1) Year except the following Equipment the guarantee period of which shall be as follows :

<u>Equipment</u>	<u>Period of Guarantee (Year)</u>
- Fault Recording System	2
- Control and Protection System	2

- For 500 kV System

The Contractor shall guarantee the proper functioning of the Work for a period of five (5) Years.

**Defective Equipment to be replaced with the whole new set**

Not Applicable

**Anti-Corruption Compliance Checklist**  
**(Individual Company / Joint Venture)**

Bidders shall provide written anti-corruption policies and guidelines with respect to procurement and supplies pursuant to the Notification of the Anti-Corruption Co-Operation Committee Concerning Minimum Standards of the Anti-Corruption Policies and Guidelines in Relation to Procurement and Supplies Required to be Implemented by the Business Operator, in accordance with Section 19 of the Government Procurement and Supplies Management Act B.E. 2560 (A.D. 2017). This checklist shall be submitted with Bids.

Project : .....

State Agency: Electricity Generating Authority of Thailand

Bidder Name : .....

Item	Yes	No	Reference (Please specify Article)
1. Bidders have any written anti-corruption policies and guidelines which have been communicated to all levels of employees.			
2. Bidders impose penalty or regulations against corruption.			
3. Bidders have accessible channels or systems to report any suspicions or queries related to corruption.			
4. Bidders have internal personnel or unit explicitly responsible for the prevention of corruption.			

We hereby confirm that all above statements are true and correct.

Signed

\_\_\_\_\_

(Name of Bidder)

(Authorized person)

Stamp company seal (if any)



**Anti-Corruption Compliance Checklist**  
**(Consortium)**

Bidders shall provide written anti-corruption policies and guidelines with respect to procurement and supplies pursuant to the Notification of the Anti-Corruption Co-Operation Committee Concerning Minimum Standards of the Anti-Corruption Policies and Guidelines in Relation to Procurement and Supplies Required to be Implemented by the Business Operator, in accordance with Section 19 of the Government Procurement and Supplies Management Act B.E. 2560 (A.D. 2017). This checklist shall be submitted with Bids.

Project : .....

State Agency: Electricity Generating Authority of Thailand

Member No. ... of the consortium:

.....

Item	Yes	No	Reference (Please specify Article)
1. Bidders have any written anti-corruption policies and guidelines which have been communicated to all levels of employees.			
2. Bidders impose penalty or regulations against corruption.			
3. Bidders have accessible channels or systems to report any suspicions or queries related to corruption.			
4. Bidders have internal personnel or unit explicitly responsible for the prevention of corruption.			

We hereby confirm that all above statements are true and correct.

Signed

\_\_\_\_\_  
(Name of Bidder)  
(Authorized person)  
Stamp company seal (if any)

# **ELECTRICITY GENERATING AUTHORITY OF THAILAND**

Nonthaburi  
Thailand

## **INVITATION TO BID NO. RTS2-S-09**

### **SUPPLY AND CONSTRUCTION OF 230/115 kV BHUMIBOL SUBSTATION (GIS) AND IMPROVEMENT OF 230 kV BHUMIBOL DAM POWER PLANT SWITCHYARD AND 230 kV TAK 2 SUBSTATION**

### **TRANSMISSION SYSTEM EXPANSION AND RENOVATION PROJECT PHASE 2 FIRE PROTECTION SYSTEM PHASE 3**

**(TWO-ENVELOPE)**

---

#### **Invitation**

The Electricity Generating Authority of Thailand (EGAT) hereby invites sealed bids for supply and construction of 230/115 kV Bhumibol Substation (GIS) and Improvement of 230 kV Bhumibol Dam Power Plant Switchyard and 230 kV Tak 2 Substation under Transmission System Expansion and Renovation Project Phase 2 and Fire Protection System Phase 3 as described herein in accordance with terms, conditions and Specifications described in these Bidding Documents.

#### **Work Description**

The supply and construction of 230/115 kV Bhumibol Substation (GIS) and Improvement of 230 kV Bhumibol Dam Power Plant Switchyard and 230 kV Tak 2 Substation will be on a supply and construction basis, the Contractor shall be responsible for complete supply, installation, construction and also engineering design work to the standard specified and best modern practice. The substations to be constructed and the scope of work under this Invitation are described in Section H. Scope of Work.

#### **Eligibility of Bidders: General Requirements**

- I. All Bidders shall meet the following requirements; failure to so comply shall constitute sufficient ground for rejection.
  - a. The Bidder shall be a partnership, firm or company, either alone or in joint venture or in consortium.
  - b. The Bidder shall be well-established and maintain a permanent place of business.

- c. The Bidder shall not be, or supply the Equipment, from the country under the state of Civil War.
- d. The Bidder shall be a juristic person who manufactures or provides such material or services, as the case may be, and not be named in the List of Work Abandoners published by the Permanent Secretary, Ministry of Finance and/or in the Debarment List and/or in the List of Work Abandoners declared by EGAT.
- e. The Bidder shall not be a Jointly Interested Bidder with other Bidders as from the date of EGAT's issuance of the Invitation to Bid, or shall not be a person who undertakes any action as an "Obstruction of Fair Price Competition" as defined in Additional Regulation for this Invitation.
- f. The Bidder shall not either be EGAT's consultant or involving in EGAT's consultancy company under this Invitation, or have EGAT's personnel involved in his business as shareholder having voting right that can control his business, director, manager, officer, employee, agent or consultant except for the ones who are officially ordered by EGAT to act or participate therein.
- g. The Bidder shall not be the person who is privileged or protected not to be taken any legal proceeding under Thai Court; provided that such Bidder's government declares that such special privilege is waived.
- h. In case of a joint venture or consortium, the Bidder shall carry out all the work under such formation from the time of bidding until the fulfillment of the Contract.
- i. ***The Bidder must have purchased the bidding documents from EGAT. For a joint venture or a consortium, only one (1) member of the joint venture or consortium is required to purchase the bidding documents.***

***In case the Bidder's name is not exactly the same as the purchaser's name, the purchaser shall notify EGAT of the name of the Bidder in writing prior to the bid opening time.***

II. All Bidders should preferably meet the following requirements; failure to so comply may constitute sufficient ground for rejection.

- a. The Bidder shall have adequate fund to meet financial obligations incidental to this Contract.
- b. The Bidder shall supply documentary evidence established in accordance with Article B-8. Information to be Submitted with Bid to demonstrate adequately that he is eligible to bid and is qualified to perform the

Contract if his bid is accepted. Bidder should also demonstrate his capacity to perform the Work either with or without the use of subcontractor.

**A-4. Eligibility of Bidders: Technical Requirements**

**I. All Bidders shall meet the following requirements; failure to so comply shall constitute sufficient ground for rejection.**

- a. Being well-established and maintaining a permanent place of business.

If the Bidder is a new company formed by acquisition of or merger with other companies or business units before submitting the Bid, the experience records of any of such previous companies or business units that meet the requirements set forth herein are acceptable as the experience records of the Bidder.

If Bidder is a new company formed by acquisition of or merger with other companies or business units, the pending claim of any of such previous companies or business units shall be considered pending claim of the Bidder.

Reference records of either the parent or affiliated companies shall not be considered as the record of such Bidder.

- b. The Bidder shall have one of the following qualifications regarding experiences executing contract of supply and construction substation.
- 1) Having experience with EGAT in executing at least one (1) contract as contractor (not as subcontractor) for supply and construction of a complete 115 kV or above conventional or GIS substation, with its overall performance satisfactory to EGAT;
  - 2) Having experience in executing at least one (1) contract as contractor (not as subcontractor) for supply and construction of a complete 220 kV or above conventional or GIS substation in an overseas country (not his own country).

Experience record of the Bidder or either member of the joint venture/consortium, including experience record derived from being a member of other joint venture or consortium in previous project(s) is acceptable. It is not allowed to combine the experience records of each member of the joint venture/consortium in order to meet the experience requirements.

- c. Further to b.1) mentioned above, having a record of experience within the last ten (10) years on the technical knowledge and practical experience on design, construction, installation and commissioning of Equipment of a 115 kV or above complete conventional or GIS substation. Bidder shall also demonstrate his capacity to perform Work.

Further to b.2) mentioned above, having a record of experience within the last ten (10) years on the technical knowledge and practical experience on design, construction, installation and commissioning of Equipment of a 220 kV or

above complete conventional or GIS substation. Bidder shall also demonstrate his capacity to perform Work.

Experience record of the Bidder or either member of the joint venture/consortium, including experience record derived from being a member of other joint venture or consortium in previous project(s) is acceptable, provided that there is a letter from the project owner certifying that the Works as described in c. above were performed by the Bidder or either member of the joint venture/consortium of this project. It is not allowed to combine the experience records of each member of the joint venture/consortium in order to meet the experience requirements.

With respect to item b. and c. above, reference records of either the parent or affiliated companies of the Bidder or of either member of joint venture or consortium shall not be acceptable. If the Bidder has previously formed as the joint venture/consortium with other company and the experience record(s) of the joint venture/consortium meet(s) the requirement set forth herein, such experience record(s) of the joint venture/consortium is(are) also acceptable as the experience record(s) of the Bidder.

d. The Bidder shall propose Equipment manufactured by the qualified manufacturers who shall fulfill the following requirements:

1. Regularly manufacturing of Equipment of the type and similar ratings proposed.
2. Being well-established and maintaining a permanent place of business.
3. The manufacturer shall have the experience records that meet the requirements set forth herein.

Reference records of either parent or affiliated companies shall not be considered as the records of such manufacturer.

4. If the Manufacturer is a new company formed by acquisition of or merger with other companies or business units, and any of such previous companies or business units has the experience records that meet the requirements set forth herein, such experience records are acceptable as the experience records of the new company, provided that each item of the equipment to be supplied under this bid shall be manufactured from the same source of supply as indicated in each of such relevant supply records as described in Item I.d.5 to I.d.7 below. Otherwise, it shall not be acceptable and shall be sufficient grounds for rejection.

For the avoidance of doubt, it is not allowed to combine the experience records of the previous companies or business units in order to meet the experience requirements.

5. For 230/115 kV Ratings of Gas-Insulated Switchgear (GIS). These Equipment shall be manufactured by the qualified manufacturers who shall fulfill the following requirements:

5.1 Having one of the following qualifications:

5.1.1 Proposing the Equipment of the type and ratings which has already been accepted by EGAT.

OR

5.1.2 For 230 kV Gas-Insulated Switchgear (GIS):

Having a supply record of Equipment of the type proposed (type of enclosure, interrupter of circuit breaker, rated filling gas pressure) at the nominal system voltage of 220 kV or above, 3000 A or above, 50 kA or above, with successful operation/use of at least three (3) consecutive years in overseas country (not his own country) and at least three (3) substations of which total GIS bays shall not be less than twelve (12).

However, the Equipment of the type and short circuit current ratings proposed shall have a supply record of successful operation/use of at least three (3) consecutive years in overseas country (not his own country) and at least one (1) substation of which total GIS bays shall not be less than four (4).

In case that the supply record of Equipment of the type and ratings proposed fulfills the requirement, the manufacturer may propose a newly developed or modified type of such Equipment with successful operation/use of at least three (3) substations of which total GIS bays shall not be less than twelve (12) and having minimum one (1) year in overseas country (not his own country). The detailed information of the development or modification shall be submitted with his proposal. EGAT, however, reserves the right and will make its own judgment whether or not to consider or accept the proposed developed or modified type.

For 115 kV Gas-Insulated Switchgear (GIS):

Having a supply record of Equipment of the type proposed (type of enclosure, interrupter of circuit breaker, rated filling gas pressure) at the nominal system voltage of 110 kV or above, 2000 A or above, 40 kA or above, with successful operation/use of at least three (3) consecutive years in overseas country (not his own country) and at least three (3) substations of which total GIS bays shall not be less than twelve (12).

However, the Equipment of the type and short circuit current ratings proposed shall have a supply record of successful operation/use of at least three (3) consecutive years in overseas country (not his own country) and at least one (1) substation of which total GIS bays shall not be less than four (4).

In case that the supply record of Equipment of the type and ratings proposed fulfills the requirement, the manufacturer may propose a newly developed or modified type of such Equipment with successful operation/use of at least three (3)

substations of which total GIS bays shall not be less than twelve (12) and having minimum one (1) year in overseas country (not his own country). The detailed information of the development or modification shall be submitted with his proposal. EGAT, however, reserves the right and will make its own judgment whether or not to consider or accept the proposed developed or modified type.

- 5.2 Having a past design test record of the Equipment as proposed, if specified in EGAT's specification. Such past design test record shall conform to the test specified in EGAT's specification.
6. For 230 kV Control and Protection System and below, having the following qualifications:
- 6.1 Being local manufacturer.
- 6.2 Having one of the following qualifications:
- 6.2.1 Having at least three (3) consecutive years' supply record of successful operation/use in 220 kV or above Transmission System of at least three (3) units of each type of Protective Relay Panels of which the characteristics are similar to the ones specified herein to EGAT or other Electricity Authorities of Thailand
- OR
- 6.2.2 Having a letter of acceptance for manufacturing of Control and Protection Boards and/or fabrication of the specific Equipment issued by EGAT within the scope specified therein.
- OR
- 6.2.3 Being listed in EGAT ACCEPTED MANUFACTURER LIST FOR CONTROL AND PROTECTION PANEL (LOCAL MANUFACTURER) attached at the end of Section A. Invitation to Bid.

7. For Substation Control and Protection System Integrator

Having one of the following qualifications:

- 7.1 Having successful experience in EGAT's digital substation.
- OR
- 7.2 Having at least two (2) records of practical experience on design and implementation of an IEC 61850 based control and protection system of a complete conventional or GIS with 110 kV or above digital substation (both station bus and process bus) with at least two (2) consecutive years of successful operation in overseas utilities (not his own country).

**II. All Bidders should preferably meet the following technical requirements; failure to so comply may constitute sufficient ground for rejection.**

- a. The Bidder shall have sufficient capacity to carry out the work.
- b. The Bidder shall have no just or proper claims pending against him with respect to breach in the performance of Contract on other similar works awarded by EGAT. In case the Bidder is a joint venture/consortium, either member of the joint venture/consortium shall have no just or proper claims pending against him with respect to breach in the performance of Contract on other similar works awarded by EGAT.
- c. The Bidder himself or his subcontractors, at the time of submitting this proposal, shall not carry excessive work nor be in a default position with respect to work with EGAT. Unsatisfactory past performance on Contract awarded by EGAT may be a sufficient reason of being disqualified.
- d. The Bidder shall propose Equipment from manufacturers who fulfill the requirements below. If there is any deficiency, EGAT reserves the right to require the Bidder to propose new manufacturer or new type/model of Equipment without any additional cost to EGAT.
  1. Regularly manufacturing of Equipment of the type and similar ratings proposed.
  2. Being well-established and maintaining a permanent place of business
  3. The manufacturer shall have the experience records that meet the requirements set forth herein.

Reference records of either parent or affiliated companies shall not be considered as the records of such manufacturer.

4. If the Manufacturer is a new company formed by acquisition of or merger with other companies or business units, and any of such previous companies or business units has the experience records that meet the requirements set forth herein, such experience records are acceptable as the experience records of the new company, provided that each item of the equipment to be supplied under this bid shall be manufactured from the same source of supply as indicated in each of such relevant supply records as described in Item II.d.5 thru II.d.19 below.

For the avoidance of doubt, it is not allowed to combine the experience records of the previous companies or business units in order to meet the experience requirements.

5. For 230/115 kV Ratings of Power Circuit Breaker, Disconnecting Switch and 115 kV Compact Switchgear shall be manufactured by the qualified manufacturers who shall fulfill the following requirements:
  - 5.1 Having one of the following qualifications:
    - 5.1.1 Proposing the Equipment of the type and ratings which has already been accepted by EGAT.



OR

5.1.2 For 230 kV Power Circuit Breaker and Disconnecting Switch:

Having a supply record of Equipment of the type proposed at nominal system voltage of 220 kV or above, 3000 A or above, 50 kA or above, with successful operation/use of at least three (3) consecutive years in an overseas country (not his own country) and at least three (3) three phase sets.

However, the Equipment of the type and short circuit current ratings proposed shall have a supply record of successful operation/use of at least three (3) consecutive years in overseas country (not his own country) and at least one (1) three phase set.

In case that the supply record of Equipment of the type and ratings proposed fulfilled the requirement, the manufacturer may propose a newly developed or modified type of such Equipment with successful operation/use of at least one (1) year in overseas country (not his own country) and at least three (3) three phase sets. The detailed information of the development or modification shall be submitted with his proposal. EGAT, however, reserves the right and will make its own judgment whether or not to consider or accept the proposed developed or modified type.

For 115 kV Power Circuit Breaker, Disconnecting Switch and Compact Switchgear:

Having a supply record of Equipment of the type proposed at nominal system voltage of 110 kV or above, 2000 A or above, 40 kA or above, with successful operation/use of at least three (3) consecutive years in an overseas country (not his own country) and at least three (3) three phase sets.

However, the Equipment of the type and short circuit current ratings proposed shall have a supply record of successful operation/use of at least three (3) consecutive years in overseas country (not his own country) and at least one (1) three phase set.

In case that the supply record of Equipment of the type and ratings proposed fulfilled the requirement, the manufacturer may propose a newly developed or modified type of such Equipment with successful operation/use for at least one (1) year in overseas country (not his own country) and at least three (3) three phase sets. The detailed information of the development or modification shall be submitted with his proposal. EGAT, however, reserves the right and will make its own judgment whether or not to consider or accept the proposed developed or modified type.

- 5.2 Having a past design test record of the Equipment as proposed, if specified in EGAT's specification. Such past design test record shall conform to the test specified in EGAT's specification.
6. For 230/115 kV Ratings of following Equipment: Instrument Transformer and Surge Arrester. These Equipment shall be manufactured by the qualified manufacturers who shall fulfill the following requirements:

6.1 Having one of the following qualifications:

6.1.1 Proposing the Equipment of the type and ratings which has already been accepted by EGAT.

OR

6.1.2 Having a supply record of Equipment of the type and ratings proposed with successful operation/use of at least three (3) three phase sets and having minimum three (3) consecutive years in an overseas country (not his own country).

In case that the supply record of Equipment of the type and ratings proposed fulfills the requirement, the manufacturer may propose a newly developed or modified type of such Equipment with successful operation/use of at least three (3) three phase sets and having minimum one (1) year in overseas country (not his own country). The detailed information of the development or modification shall be submitted with his proposal. EGAT, however, reserves the right and will make its own judgment whether or not to consider or accept the proposed developed or modified type.

Supply records of the higher rating Equipment shall not be considered if the Bidder does not propose such higher rating Equipment in his bid.

6.2 Having a past design test record of the Equipment as proposed, if specified in EGAT's specification. Such past design test record shall conform to the test specified in EGAT's specification.

7. For 33, 22 and 11 kV ratings of following Equipment: Metal-Clad SF<sub>6</sub> Gas Insulated Switchgear, Power Circuit Breaker, Instrument Transformer, Disconnecting Switch and Surge Arrester

Having one of the following qualifications:

7.1 Proposing the Equipment of the type and ratings which has already been accepted by EGAT.

OR

7.2 Having a supply record of Equipment of the type and ratings proposed with successful operation/use of at least three (3) consecutive years in an overseas country (not his own country) and

at least three (3) three phase sets. The ratings and features of Equipment shall be the same or similar rating as EGAT specifies.

In case that the supply record of Equipment of the type and ratings proposed fulfilled the requirement, the manufacturer may propose a newly developed or modified type of such Equipment with successful operation/use of at least one (1) year in overseas country (not his own country) and at least three (3) three phase sets. The detailed information of the development or modification shall be submitted with his proposal. EGAT, however, reserves the right and will make its own judgment whether or not to consider or accept the proposed developed or modified type.

Supply records of the higher rating Equipment shall not be considered if the Bidder does not propose such higher rating Equipment in his bid.

8. For Distribution Transformer, Power Fuse, AC&DC Distribution Board and Lighting Relay Panel (LRP), Load Center Unit Substation (LCUS), Junction Box, Battery Charger, Substation Steel Structure, 33 kV and below Cable Terminations, 115 kV and below XLPE Power Cable, Power Cable, Control Cable and Switchboard Wire, Lighting Cable, Copper Ground Wire, Overhead Ground Wire, Aluminum Conductor, Optical Fiber Cable, Switchyard Lighting Fixtures, Aluminum Tube, Compression Connector and Miscellaneous Hardware, Bus Fittings, Ground Rod, Thermite Welding Material, Grounding Hardware, Conduit and Conduit Fittings

- 8.1 Being local manufacturer for the following Equipment:

Distribution Transformer, AC&DC Distribution Board and Lighting Relay Panel (LRP), Load Center Unit Substation (LCUS), Junction Box, Battery Charger, Substation Steel Structure, 115 kV and below XLPE Power Cable, Power Cable, Control Cable and Switchboard Wire, Lighting Cable, Copper Ground Wire, Overhead Ground Wire, Aluminum Conductor, Single mode optical fiber cable, Switchyard Lighting Fixtures, Aluminum Tube, Compression Connector and Miscellaneous Hardware, Thermite Welding Material and Conduit.

- 8.2 Having been granted a license for producing standard product by Thai Industrial Standard Institute (TISI), Ministry of Industry for the following Equipment:

60 kV through 115 kV XLPE Power Cable, Lighting cable and Aluminum conductor.

- 8.3 Having one of the following qualifications:

- 8.3.1 Having supply record of Equipment of the type and similar ratings proposed with successful operation/use for at least one (1) year.

OR

8.3.2 Having a letter of acceptance for manufacturing and/or fabrication of the specific Equipment issued by EGAT within the scope specified therein (For the local manufacturer).

9. For Insulator

Having one of the following qualifications:

9.1 Having supply record with successful operation/use for at least three (3) consecutive years in overseas country (not his own country) and for following equipment:

9.1.1 Suspension Insulator, at least 10,000 units having the similar ANSI class as proposed.

9.1.2 Station Post Insulator, having the similar ANSI technical reference number as proposed.

OR

9.2 Having a letter of acceptance for manufacturing and/or fabrication of the specific Equipment issued by EGAT within the scope specified therein (For the local manufacturer).

10. For Stationary Battery

Having one of the following qualifications:

10.1 Having supply record of Equipment of the type and similar ratings proposed with successful operation/use in substations/switchyards of at least three (3) consecutive years and at least three (3) sets.

In case that the supply record of Equipment of the type and similar ratings proposed fulfilled the requirements, the manufacturer may propose a newly developed or modified type of such Equipment with successful operation/use of at least one (1) year. The detailed information of the development or modification shall be submitted with his proposal. EGAT, however, reserves the right and will make its own judgement whether or not to consider or accept the proposed developed or modified type.

OR

10.2 Having a letter of acceptance for manufacturing and/or fabrication of the specific Equipment issued by EGAT within the scope specified therein (For the local manufacturer).

11. For above 33kV through 230 kV Outdoor Type Cable Termination and Cable Termination for GIS.

Having one of the following qualifications:

11.1 Proposing the Equipment of the type and ratings which have ever been accepted by EGAT.

OR

- 11.2 Having a supply record of Equipment of the type and ratings proposed with successful operation/use for at least three (3) consecutive years in an overseas country (not his own country) and at least five (5) three phase sets. The ratings and features of Equipment shall be the same or similar rating as EGAT specifies.

In case that the supply record of Equipment of the type and ratings proposed fulfilled the requirement, the manufacturer may propose a newly developed or modified type of such Equipment with successful operation/use for at least one (1) year in overseas country (not his own country) and at least five (5) three phase sets. The detailed information of the development or modification shall be submitted with his proposal. EGAT, however, reserves the right and will make its own judgment whether or not to consider or accept the proposed developed or modified type.

Supply records of the higher rating Equipment shall not be accepted if the Bidder does not propose such higher rating Equipment in his bid.

12. For 230 kV XLPE Power Cable

Having one of the following qualifications:

- 12.1 Having a supply record of Equipment of the type and similar ratings proposed with successful operation/use for at least three (3) consecutive years in an overseas country (not his own country).

OR

- 12.2 Having a letter of acceptance for manufacturing and/or fabrication of the specific Equipment issued by EGAT within the scope specified therein (For the local manufacturer).

13. Proposing the protective relays from the manufacturers as listed in EGAT ACCEPTED MANUFACTURER LIST FOR PROTECTIVE RELAY attached at the end of Section A. Invitation to Bid and shall be in compliance with the details specified in EGAT's Specifications. Type/Model of the main protective relays proposed shall be as specified in EGAT ACCEPTED MAIN RELAY LIST NO.1 and NO.2 attached at the end of Section A. Invitation to Bid.

14. For Fault Recording System.

14.1 Having one of the following qualifications:

- 14.1.1 The cabinet and all Equipment are completely wired by the FRS manufacturer before shipping to Thailand.

OR

14.1.2 The cabinet and the Equipment are wired in Thailand by the local cabinet manufacturer who has one of the following qualifications:

14.1.2.1 Having a letter of acceptance for manufacturing of Control and Protection Boards and/or fabrication of the specific Equipment issued by EGAT within the scope specified therein.

OR

14.1.2.2 Being listed in EGAT ACCEPTED MANUFACTURER LIST FOR CONTROL AND PROTECTION PANEL (LOCAL MANUFACTURER) attached at the end of Section A. Invitation to Bid.

The design and engineering shall be performed by the FRS manufacturer. The assembly, factory test and commissioning shall be in accordance with the FRS manufacturer's standard and shall be performed under the FRS manufacturer's supervisor.

14.2 Proposing the Fault Recording System (FRS) from the manufacturers as listed in EGAT ACCEPTED MANUFACTURER LIST FOR FAULT RECORDING SYSTEM attached at the end of Section A. Invitation to Bid and shall be in compliance with the details specified in EGAT's Specifications. Type/model of FRS proposed shall be as specified in EGAT ACCEPTED FAULT RECORDING SYSTEM LIST attached at the end of Section A. Invitation to Bid.

15. For supervisory software of IEC 61850 based substation control and protection system:

Having at least one (1) supply record of implementing supervisory software in IEC 61850 based substation control and protection system which comprises at least two (2) manufacturers of protective Intelligent Electronic Device (IED) with successful operation and use of at least one (1) year.

16. For Merging Unit (MU)

Having one of the following qualifications:

16.1 Proposing the MU of the type and rating which has already been successfully operated in EGAT's digital substation.

OR

16.2 Proposing the MU from the manufacturers as listed in EGAT ACCEPTED MANUFACTURER LIST FOR PROTECTIVE RELAY attached at the end of Section A. Invitation to Bid and shall be in compliance with the details specified in EGAT's Specifications.

AND

Having supply records of at least three (3) digital substations (both station bus and process bus) of the type proposed with at least three (3) consecutive years of successful operation at nominal system voltage of 110 kV or above in overseas utilities (not his own country).

17. For Bay Control Unit (BCU)

Having one of the following qualifications:

17.1 Proposing the BCU of the type and rating which has already been successfully operated in EGAT's digital substation.

OR

17.2 Proposing the BCU from the manufacturers as listed in EGAT ACCEPTED MANUFACTURER LIST FOR PROTECTIVE RELAY attached at the end of Section A. Invitation to Bid and shall be in compliance with the details specified in EGAT's Specifications.

AND

Having supply records of at least three (3) digital substations (both station bus and process bus) of the type proposed with at least three (3) consecutive years of successful operation at nominal system voltage of 110 kV or above in overseas utilities (not his own country).

18. Being local manufacturer for steel supporting structure of Instrument Transformer, Surge Arrester and Disconnecting Switch.

19. For Closed-circuit television (CCTV) system and equipment

19.1 Proposed camera and Network Video Recorder (NVR) manufacturer shall have a representative or a branch office of manufacturer in Thailand for at least ten (10) years.

19.2 Proposed brand of IP cameras shall have a supply record of IP cameras for at least five hundred (500) IP cameras per contract with successful operation/use for at least three (3) years in Thailand.

19.3 The bidder or subcontractor shall have one of the following qualifications:

19.3.1 Having experiences in installation and cabling of outdoor-type IP cameras for at least fifty (50) cameras per contract with successful operation/use for at least three (3) years in Thailand.

OR

19.3.2 Having experiences in optical fiber cabling in substation switchyards for at least five (5) substations per contract with successful operation/use for at least three (3) years in Thailand.

19.4 Being local manufacturer for the following Equipment: CCTV Rack cabinet, Monitoring desk, CCTV pole, 12-core ADSS optical fiber cable.

- e. Proposing the manufacturer who has no just or proper claims pending against Equipment of the same type/model to be proposed under this bid.

In case the manufacturer is a new company formed by acquisition or merger with other companies or business units, the pending claim of any of such previous companies or business units shall be considered pending claim of the manufacturer.

- f. Proposing reputable subcontractors, for the portion of the work to be subcontracted, having adequate technical knowledge, ability and capacity to perform such work and having at least three years experience in the performance of similar work and of equal magnitude to the work to be subcontracted. If any proposed subcontractor(s) is (are) not qualified in the opinion of EGAT, the Bidder is required to select other subcontractor(s) at his own cost to the satisfaction of EGAT.

**Definitions:**

**Complete substation:**

New substation or Extension of the existing substation which comprise of at least one transformer circuit and one line circuit.

All above scope may not be necessary to include the building construction and the civil works by themselves. However, the design, supervision, and execution of the buildings and the civil works shall be required.

**Year(s) of operation/use:**

The period of operation Completion date or Commissioning date or Taking over date or Operation date or Put in service date stated in End User Certificate or the sufficient documentary evidence before bid opening.

\*\*\*\*\*



EGAT ACCEPTED MAIN RELAY LIST No.1

Description	Manufacturer	Accepted Type	Accepted Voltage Level			Notes
			500 kV	230 kV	115&69 kV	
Current Differential Protection	ABB	RED670 (*)	✓	✓	✓	
	GE	P543	✓	✓	✓	
		L90	✓	✓	✓	
	SEL	SEL-311L	✓	✓	✓	
		SEL-411L (*)	✓	✓	✓	
	Siemens	7SD52 (**)	✓	✓	✓	
	Schneider Electric	P543 (*)	✓	✓	✓	
	Ingeteam	EF-LD (*)	✓	✓	✓	
NR Electric	PCS-931 (*)	✓	✓	✓		
Distance Protection	ABB	REL670 (*)	✓	✓	✓	
	GE	P443	✓	✓	✓	
		D30			✓	Only for three-pole tripping and line protection without carrier scheme.
		D60		✓	✓	
		ALPSDA1	✓	✓	✓	
	SEL	SEL-311C			✓	Only for three-pole tripping and line protection without carrier scheme.
		SEL-421 (*)	✓	✓	✓	
		SEL-411L (*)	✓	✓	✓	
	Siemens	7SA522 (**)	✓	✓	✓	
		7SA6 series (**)	✓	✓	✓	
7SA87 (*)		✓	✓	✓		

BID NO. RTSS2-S-09

**เอกสารควบคุม**  
 รับรองสำเนาโดย ททอ-ส.กสส.อ.วส.  
 ก่อนนำไปใช้งาน  
 ต้องตรวจสอบ Revision สำคัญ  
 ฝ่ายวิศวกรรมระบบส่ง กฟผ.



EGAT ACCEPTED MAIN RELAY LIST No.1

Description	Manufacturer	Accepted Type	Accepted Voltage Level			Notes
			500 kV	230 kV	115&69 kV	
Distance Protection	Schneider Electric	P443 (*)	✓	✓	✓	
	Ingeteam	EF-ZT (*)	✓	✓	✓	
	NR Electric	PCS-902 (*)	✓	✓	✓	
	Toshiba	GRZ200 (*)		✓	✓	
	ZIV	ZLV		✓	✓	
Transformer Differential Protection	ABB	RET670 (*)	✓	✓	✓	
		RET650 (**)	✓	✓	✓	3-restraints
	GE	P64x	✓	✓	✓	
		T35		✓	✓	
		T60		✓	✓	
	SEL	SEL-387		✓	✓	4-restraints
		SEL-487E (*)	✓	✓	✓	
		SEL-587			✓	2-restraints
		SEL-787 (**)			✓	4-restraints
	Siemens	Duobias (**)		✓	✓	
		7UT6 (**)	✓	✓	✓	5-restraints
		7UT82 (*)	✓	✓	✓	2-restraints
		7UT86 (*)	✓	✓	✓	3-restraints
	Schneider Electric	P645 (*)	✓	✓	✓	
	Ingeteam	EF-TD (*)	✓	✓	✓	3-restraints
	NR Electric	PCS-978 (*)	✓	✓	✓	
	Toshiba	GRT200 (*)	✓	✓	✓	
	ZIV	IDV	✓	✓	✓	
	Mitsubishi	MRD-HA (**)			✓	3-restraints

**เอกสารควบคุม**  
 รับรองสำเนาโดย พทอ.ส.กสส.ส.จวส.  
 ก่อนนำไปใช้งาน  
 ต้องตรวจสอบ Revision ล่าสุด  
 ฝ่ายวิศวกรรมระบบส่ง กฟผ.



EGAT ACCEPTED MAIN RELAY LIST No.1

Description	Manufacturer	Accepted Type	Accepted Voltage Level			Notes
			500 kV	230 kV	115&69 kV	
High Impedance	ABB	REB650 (**)	✓	✓	✓	
Busbar Protection	SEL	SEL-587Z	✓	✓	✓	
Low Impedance Busbar Protection	ABB	REB670 (*)	✓	✓	✓	
		REB500	✓	✓	✓	
	GE	P746	✓	✓	✓	
		P740	✓	✓	✓	
		P747	✓	✓	✓	
		B90	✓	✓	✓	
		B30	✓	✓	✓	Only for breaker and a half, double bus double breaker or main and transfer bus arrangement.
		SEL	SEL-487B (*)	✓	✓	✓
	Siemens	7SS52 (**)	✓	✓	✓	
		7SS60	✓	✓	✓	Only for breaker and a half, double bus double breaker or main and transfer bus arrangement.
	Schneider Electric	7SS85 (*)	✓	✓	✓	
		P746 (*)	✓	✓	✓	
		P740 (**)	✓	✓	✓	
	Toshiba	GRB200 (*)	✓	✓	✓	
Mitsubishi	MBP-H1A (**)		✓	✓	In case of double bus single breaker arrangement, maximum 8 feeders with 1 bus coupler and 2 bus sections are allowed.	

**เอกสารควบคุม**

รับรองสำเนาโดย พพอ-ส.กสส-ส.อวส.  
ก่อนนำไปใช้งาน  
ต้องตรวจสอบ Revision ล่าสุด  
ฝ่ายวิศวกรรมระบบส่ง กฟผ.

19 Jul 2022

EGAT ACCEPTED MAIN RELAY LIST No.1

Description	Manufacturer	Accepted Type	Accepted Voltage Level			Notes
			500 kV	230 kV	115&69 kV	
Breaker Failure Protection	ABB	REQ650 (**)			✓	
	GE	P141			✓	Only for 3-phase breaker failure function.
		P14Nx	✓	✓	✓	
		C60		✓	✓	
		F60		✓	✓	
	SEL	SEL-501			✓	Only for 3-phase breaker failure function.
	Siemens	7VK6 series (**)	✓	✓	✓	
		7SJ82 (*)			✓	Only for 3-phase breaker failure function.
	Schneider Electric	P821		✓	✓	Only firmware version 1.F is accepted.
	Ingeteam	EF-ZT (*)	✓	✓	✓	
	NR Electric	PCS-9611 (*)			✓	Only for 3-phase breaker failure function.
	Toshiba	GRD200 (*)	✓	✓	✓	
ZIV	IRL			✓	Only for 3-phase breaker failure function.	

Remarks

- (\*) Applicable to IEC 61850 for both station bus and process bus with the certification issued by the third party laboratory and specifying that the said relay conforms to "IEC 61850 edition 2 parts 6, 7-1, 7-2, 7-3, 7-4, and 8-1".
- (\*\*) Applicable to IEC 61850 only for station bus with the certification issued by the third party laboratory and specifying that the said relay conforms to "IEC 61850 edition 2 parts 6, 7-1, 7-2, 7-3, 7-4, and 8-1".

Notes

1. The procedures for being listed in EGAT ACCEPTED MAIN RELAY LIST are specified in the EGAT's Pre-Qualification (PQ) process, of which the details can be provided by Transmission System Engineering Division on request.
2. If any types of relay in the list are planned to discontinue the manufacturing, the manufacturer or the representative is responsible for informing EGAT at least 1 year before the unavailable date.
3. The relays shall be configured to comply with all EGAT's required functions.

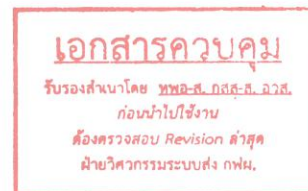

EGAT ACCEPTED MAIN RELAY LIST No.2

Description	Manufacturer	Accepted Type	Accepted Voltage Level				Notes
			500 kV	230 kV	115&69 kV	33&22 kV	
Directional Overcurrent Relay	ABB	REQ650 (**)	✓	✓	✓	✓	
	GE	P14Dx	✓	✓	✓	✓	
		P841	✓	✓	✓	✓	
		P143	✓	✓	✓	✓	
	SEL	SEL-351A	✓	✓	✓	✓	
		SEL-451 (*)	✓	✓	✓	✓	
		SEL-751 (**)	✓	✓	✓	✓	
	Siemens	7SJ62 (**)	✓	✓	✓	✓	
		7SJ85 (*)	✓	✓	✓	✓	
		7SJ82 (*)	✓	✓	✓	✓	
	Schneider Electric	P141 (**)	✓	✓	✓	✓	
		P143 (**)	✓	✓	✓	✓	
	Ingeteam	EF-MD (*)	✓	✓	✓	✓	
		DA-PT (**)	✓	✓	✓	✓	
	NR Electric	PCS-9611 (*)				✓	None of line fault locator. Only use with feeder.
	Toshiba	GRE140	✓	✓	✓	✓	
GRD200 (*)		✓	✓	✓	✓		
ZIV	IRV		✓	✓	✓		
Overcurrent Relay	ABB	REQ650 (**)	✓	✓	✓	✓	
	GE	P141	✓	✓	✓	✓	
		P14Dx	✓	✓	✓	✓	
		P14Nx	✓	✓	✓	✓	
		P841	✓	✓	✓	✓	
		F60	✓	✓	✓	✓	

**เอกสารควบคุม**

รับรองสำเนาโดย ททอ-ส.กสส-ส.อวส.  
ก่อนนำไปใช้งาน  
ต้องตรวจสอบ Revision สำคัญ  
ฝ่ายวิศวกรรมระบบส่ง กฟผ.

EGAT ACCEPTED MAIN RELAY LIST No.2

Description	Manufacturer	Accepted Type	Accepted Voltage Level				Notes
			500 kV	230 kV	115&69 kV	33&22 kV	
Overcurrent Relay	GE	F650	✓	✓	✓	✓	
		SR350	✓	✓	✓	✓	
		P143	✓	✓	✓	✓	
	SEL	SEL-351A	✓	✓	✓	✓	
		SEL-451 (*)	✓	✓	✓	✓	
		SEL-551	✓	✓	✓	✓	
		SEL-751 (**)	✓	✓	✓	✓	
		SEL-751A	✓	✓	✓	✓	
	Siemens	7SJ61 (**)	✓	✓	✓	✓	
		7SJ62 (**)	✓	✓	✓	✓	
		7SJ85 (*)	✓	✓	✓	✓	
		7SJ82 (*)	✓	✓	✓	✓	
	Schneider Electric	P120	✓	✓	✓	✓	
		P122	✓	✓	✓	✓	
		P141 (**)	✓	✓	✓	✓	
		P143 (**)	✓	✓	✓	✓	
	Ingeteam	EF-MD (*)	✓	✓	✓	✓	
		DA-PT (**)	✓	✓	✓	✓	
	NR Electric	PCS-9611 (*)			✓	✓	Only for three-pole tripping.
	Toshiba	GRE140	✓	✓	✓	✓	
GRD200 (*)		✓	✓	✓	✓		
ZIV	IRV		✓	✓	✓		
	IRL	✓	✓	✓	✓		

**เอกสารควบคุม**

รับรองสำเนาโดย ททอ-ส.กส.ส.ฉ.ว.ส.  
ก่อนนำไปใช้งาน  
ต้องตรวจสอบ Revision สำคัญ  
ฝ่ายวิศวกรรมระบบส่ง กฟผ.

EGAT ACCEPTED MAIN RELAY LIST No.2

Description	Manufacturer	Accepted Type	Accepted Voltage Level				Notes
			500 kV	230 kV	115&69 kV	33&22 kV	
Synchronism Check Relay	ABB	REQ650 (**)	✓	✓	✓		Only product version 2.1 is accepted.
	GE	P841	✓	✓	✓		
		F60	✓	✓	✓		
		F650	✓	✓	✓		
	SEL	SEL-351A	✓	✓	✓		
		SEL-451 (*)	✓	✓	✓		
		SEL-751 (**)	✓	✓	✓		
		SEL-751A	✓	✓	✓		
	Siemens	7VK61 (**)	✓	✓	✓		
		7SJ85 (*)	✓	✓	✓		
		7SJ82 (*)	✓	✓	✓		
	Ingeteam	EF-MD (*)	✓	✓	✓		
		DA-PT (**)	✓	✓	✓		
	NR Electric	PCS-9611 (*)	✓	✓	✓		
Toshiba	GRD200 (*)	✓	✓	✓			
Auto Reclosing Relay	ABB	REQ650 (**)	✓	✓	✓		
	GE	P841	✓	✓	✓		
		F60			✓		Only for three-pole reclose
		F650			✓		Only for three-pole reclose
		DRS			✓		Only for three-pole reclose

Bid No. RTS2-S-09

**เอกสารควบคุม**  
 รับรองสำเนาโดย พหวิ-ส. กสส-ส. อวส.  
 ก่อนนำไปใช้งาน  
 ต้องตรวจสอบ Revision ล่าสุด  
 ฝ่ายวิศวกรรมระบบส่ง กฟผ.

19 Jul 2022

EGAT ACCEPTED MAIN RELAY LIST No.2

Description	Manufacturer	Accepted Type	Accepted Voltage Level				Notes
			500 kV	230 kV	115&69 kV	33&22 kV	
Auto Reclosing Relay	SEL	SEL-351A			✓		Only for three-pole reclose
		SEL-451 (*)			✓		Only for three-pole reclose
		SEL-751 (**)			✓		Only for three-pole reclose
	Siemens	7VK61 (**)	✓	✓	✓		
		7SJ82 (*)			✓		Only for three-pole reclose
	Ingeteam	EF-ZT (*)	✓	✓	✓		
	NR Electric	PCS-9611 (*)			✓		Only for three-pole reclose
Toshiba	GRD200 (*)	✓	✓	✓			
Overfluxing Relay	Ingeteam	EF-TD (*)	✓	✓	✓		
Frequency Relay	GE	P94Vx	✓	✓	✓	✓	
		MIV		✓	✓	✓	
	SEL	SEL-351A	✓	✓	✓	✓	
		SEL-451 (*)	✓	✓	✓	✓	
		SEL-751 (**)	✓	✓	✓	✓	
		SEL-751A	✓	✓	✓	✓	
	Siemens	7SJ85 (*)	✓	✓	✓	✓	
		7SJ82 (*)	✓	✓	✓	✓	
	Ingeteam	EF-MD (*)	✓	✓	✓	✓	
		DA-PT (**)	✓	✓	✓	✓	
	NR Electric	PCS-9611 (*)	✓	✓	✓	✓	
	ZIV	IRL	✓	✓	✓	✓	
Under/Overvoltage Relay	GE	MIV		✓	✓	✓	
		P94V	✓	✓	✓	✓	None of VT input (open delta connection) for 59N.

**เอกสารควบคุม**

รับรองสำเนาโดย ทพอ.ส.กสส.ส.อวส.  
ก่อนนำไปใช้งาน  
ต้องตรวจสอบ Revision สำคัญ  
ฝ่ายวิศวกรรมระบบส่ง กฟผ.

19 Jul 2022



EGAT ACCEPTED MAIN RELAY LIST No.2

Description	Manufacturer	Accepted Type	Accepted Voltage Level				Notes
			500 kV	230 kV	115&69 kV	33&22 kV	
Under/Overvoltage Relay	SEL	SEL-351A	✓	✓	✓	✓	
		SEL-751 (**)	✓	✓	✓	✓	
		SEL-751A	✓	✓	✓	✓	
	Siemens	7SJ62 (**)	✓	✓	✓	✓	
		7SJ85 (*)	✓	✓	✓	✓	
		7SJ82 (*)	✓	✓	✓	✓	
	Schneider Electric	P141 (**)	✓	✓	✓	✓	
		P143 (**)	✓	✓	✓	✓	
	Ingeteam	EF-MD (*)	✓	✓	✓	✓	
		DA-PT (**)	✓	✓	✓	✓	
	NR Electric	PCS-9611 (*)		✓	✓	✓	Only for C-bank protection.
	Toshiba	GRD200 (*)	✓	✓	✓	✓	
ZIV	IRV	✓	✓	✓	✓		

Remarks

- (\*) Applicable to IEC 61850 for both station bus and process bus with the certification issued by the third party laboratory and specifying that the said relay conforms to "IEC 61850 edition 2 parts 6, 7-1, 7-2, 7-3, 7-4, and 8-1".
- (\*\*) Applicable to IEC 61850 only for station bus with the certification issued by the third party laboratory and specifying that the said relay conforms to "IEC 61850 edition 2 parts 6, 7-1, 7-2, 7-3, 7-4, and 8-1".

Notes

1. The procedures for being listed in EGAT ACCEPTED MAIN RELAY LIST are specified in the EGAT's Pre-Qualification (PQ) process, of which the details can be provided by Transmission System Engineering Division on request.
2. If any types of relay in the list are planned to discontinue the manufacturing, the manufacturer or the representative is responsible for informing EGAT at least 1 year before the unavailable date.
3. The relays shall be configured to comply with all EGAT's required functions.

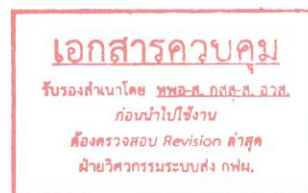

19 Jul 2022

EGAT ACCEPTED FAULT RECORDING SYSTEM LIST

Accepted Type	Manufacturer
IDM+	Qualitrol
M871	GE
7KE85 (*)	Siemens
TESLA 4000 (*)	ERL Phase
TR 2100	Rochester (RIS)

Remarks

- (\*) Applicable to IEC 61850 for both station bus and process bus with the certification issued by the third party laboratory and specifying that the said FRS conforms to "IEC 61850 edition 2 parts 6, 7-1, 7-2, 7-3, 7-4, and 8-1".
- (\*\*) Applicable to IEC 61850 only for station bus with the certification issued by the third party laboratory and specifying that the said FRS conforms to "IEC 61850 edition 2 parts 6, 7-1, 7-2, 7-3, 7-4, and 8-1".

Notes

- The procedures for being listed in EGAT ACCEPTED FAULT RECORDING SYSTEM LIST are specified in the EGAT's Pre-Qualification (PQ) process, of which the details can be provided by Transmission System Engineering Division on request.
- If any types of FRS in the list are planned to discontinue the manufacturing, the manufacturer or the representative is responsible for informing EGAT at least 1 year before the unavailable date.

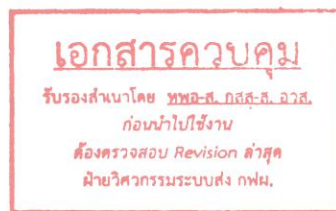

19 Jul 2022

EGAT ACCEPTED MANUFACTURER LIST FOR PROTECTIVE RELAY

Description	Manufacturer / Country
Protective Relay	ABB / Sweden, Switzerland, USA
	GE / USA, Canada, Spain, UK
	SEL / USA
	Siemens / Germany, UK
	Toshiba / Japan, Vietnam
	Schneider Electric / France, UK
	ZIV / Spain
	INGETEAM / Spain
	NR Electric / China
	Mitsubishi / Japan
	Protecta / Hungary
	Arcteq / Finland

Bid No. R152509

**เอกสารควบคุม**  
 รับรองสำเนาโดย ทพอ.ส. กสศ.ส.ฉวส.  
 ก่อนนำไปใช้งาน  
 ต้องตรวจสอบ Revision ล่าสุด  
 ฝ่ายวิศวกรรมระบบส่ง กฟผ.

19 Jul 2022

EGAT ACCEPTED MANUFACTURER LIST FOR FAULT RECORDING SYSTEM

Description	Manufacturer / Country
Fault Recording System	Qualitrol / UK
	Siemens / Germany
	Rochester / USA
	GE / USA
	ERL Phase / Canada

Bid No. RTS2-S-09

**เอกสารควบคุม**  
รับรองสำเนาโดย ทพอ.ส.กสิ.ส. ลวส.  
ก่อนนำไปใช้งาน  
ต้องตรวจสอบ Revision คำสุด  
ท้ายวิศวกรรมระบบส่ง กฟผ.

19 Jul 2022

EGAT ACCEPTED MANUFACTURER LIST FOR  
CONTROL AND PROTECTION PANEL (LOCAL MANUFACTURER)

Description	Manufacturer	Designed by
500 kV Control and Protection Panel	Hitachi Energy (Thailand) Limited	Hitachi Energy (Thailand) Limited
	Precise System and Project Co., Ltd.	Precise System and Project Co., Ltd.
	U-tah Industry Limited Partnership	U-tah Industry Limited Partnership
	SCI Electric Public Company Limited	Siemens Limited
230 kV and below Control and Protection Panel	Hitachi Energy (Thailand) Limited	Hitachi Energy (Thailand) Limited
	C&T Metal Products Co., Ltd.	Easun Reyrolle Limited, India
	Precise System and Project Co., Ltd.	Precise System and Project Co., Ltd.
	U-tah Industry Limited Partnership	U-tah Industry Limited Partnership
	SCI Electric Public Company Limited	SCI Electric Public Company Limited
	Timpano Electrical Co., Ltd.	Timpano Electrical Co., Ltd.
	Mantra Switchgear Co., Ltd.	Siemens Limited

Notes

- The procedures for being listed in EGAT ACCEPTED MANUFACTURER LIST FOR CONTROL AND PROTECTION PANEL (LOCAL MANUFACTURER) can be provided by Transmission System Planning and Project Division on request.
- The control and protection panel shall be manufactured and designed by the manufacturer/company written in the same row.

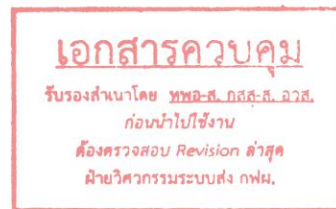

28 Oct 2022

## SCOPE OF WORK

### **H-1. General**

<u>No.</u>	<u>Substation</u>	<u>Page</u>
1.	230/115 KV BHUMIBOL SUBSTATION (GIS)	
	- GENERAL	H1-1
	- ELECTRICAL PART	H1A-1
	- CONTROL AND PROTECTION PART	H1B-1
	- COMMUNICATION PART (NONE)	-
	- CIVIL AND ARCHITECTURAL PART	H1D-1
2.	230 KV BHUMIBOL DAM POWER PLANT SWITCHYARD	
	- GENERAL	H2-1
	- ELECTRICAL PART (NONE)	-
	- CONTROL AND PROTECTION PART	H2B-1
	- COMMUNICATION PART (NONE)	-
	- CIVIL AND ARCHITECTURAL PART (NONE)	-
3.	230 KV TAK 2 SUBSTATION	
	- GENERAL	H3-1
	- ELECTRICAL PART (NONE)	-
	- CONTROL AND PROTECTION PART	H3B-1
	- COMMUNICATION PART (NONE)	-
	- CIVIL AND ARCHITECTURAL PART (NONE)	-

## **1. 230/115 KV BHUMIBOL SUBSTATION (GIS)**

### **GENERAL**

The renovation of Bhumibol Substation project to construct new 230 kV and 115 kV Gas Insulated Switchgear (GIS) substation is initiated in order to replace the existing 230 kV and 115 kV conventional substation, which have been utilized for many years shall no longer be in operation after the completion of new GIS substation.

The Bhumibol Substation is located at Sam Ngao sub-district, Sam Ngao district, Tak province. The renovation of Bhumibol Substation consists of the 230 kV GIS substation with Breaker & A Half scheme and the 115 kV GIS substation with Double Bus Single Breaker scheme which the 230 kV GIS and the 115 kV GIS are in the same building.

The scope of work comprises two (2) schedules as follows:

### **Schedule 1: 230 kV Bhumibol Substation (GIS)**

The new 230 kV GIS Bhumibol Substation shall have four (4) diameters with Breaker & A Half scheme which consist of eight (8) feeders as follows:

- Two (2) feeders for 200 MVA, 230/115-22 kV Auto Transformers KT1A & KT2A
- Two (2) feeders for 230 kV line No.1 & No.2 to BHUMIBOL HYDRO POWER PLANT
- Two (2) feeders for 230 kV line No.1 & No.2 to BHUMIBOL FLOATING SOLAR Substation
- Two (2) feeders for 230 kV line No.1 & No.2 to TAK 2 Substation

### **Schedule 2: 115 kV Bhumibol Substation (GIS)**

The new 115 kV GIS Bhumibol Substation shall have eight (8) bays with Double Bus Single Breaker scheme which consist of eight (8) feeders as follows:

- Two (2) feeders for 200 MVA, 230/115-22 kV Auto Transformers KT1A & KT2A (Plug-in 115 kV XLPE cable 2x1/C 800 Sq.mm. per phase)
- Two (2) feeders for 25 MVA, 115/22 kV Power Transformers KT3A & KT4A (Plug-in 115 kV XLPE cable 1x1/C 800 Sq.mm. per phase)
- Two (2) feeders for 115 kV line No.1 & No.2 to THOEN Substation (Plug-in 115 kV XLPE cable 1x1/C 800 Sq.mm. per phase)
- One (1) feeder for 115 kV line to TAK 1 Substation (Plug-in 115 kV XLPE cable 1x1/C 800 Sq.mm. per phase)
- One (1) feeder for 115 kV Bus Coupler

The Contractor shall supply equipment, perform construction and installation work necessary for completion of operation substation in accordance with the Contract Documents. The design work shall include, but not limited to, technical calculation, preparation of drawings, bill of materials for installation and construction work. For accomplishment of complete operational substation, Scope of Contractor's work shall include connection to all public utilities i.e. electrical power, water and drainage. Testing and commissioning of all equipment required to make the substation function properly.

Besides, all detailed engineering design work, calculations, drawing preparation, submission of backup data, test reports instruction books (and), etc. shall be included.

- 1) As stated elsewhere in this bidding documents, the drawings included in the bidding documents except drawing mark "For Construction" are for bidding purposes only and shall not be used for execution of the work.
- 2) The submitted drawings which are incomplete/unacceptable, or are the bidding document copies with minor modifications shall be returned unmarked to the Contractor.
- 3) The drawings shall be furnished which provide all details required for thoroughly described equipment as well as installation methods and requirements. However, EGAT retains the right to request additional details if those furnished are perceived inadequate.
- 4) Calculations, backup data and documentation are required for all parts of the design. The furnished data shall verify completely that design is adequate for application purpose.



## **ELECTRICAL PART**

### **Work included in this Contract.**

The Work included in this contract to be performed by the contractor shall be as specified in the contract documents and as follows:

#### **1. 230 kV & 115 kV Gas Insulated Switchgear (GIS)**

- 1.1 Design, supply and installation of equipment required for a complete new 230kV GIS substation. The 230kV GIS air bushings and 230kV GIB shall be installed on the wall of 230/115kV GIS building.
- 1.2 Design, supply and installation of equipment required for a complete new 115kV GIS substation.
- 1.3 Design, supply and installation of equipment required for a complete 22kV switchgear and 22kV-400/230V power supply system.
- 1.4 Design, supply and installation of miscellaneous hardware required for the following:
  - 1.4.1 The connection between the 230kV and 115kV substations.
  - 1.4.2 The connection of the 230kV GIS air bushings and 115kV XLPE cable termination to the 200MVA, 230/115-22kV auto-transformers (KT1A, KT2A)
  - 1.4.3 The connection of the 115kV XLPE cable termination to the 25MVA, 115/22kV power transformers (KT3A, KT4A).
  - 1.4.4 The connection of the 25MVA, 115/22kV power transformers (KT3A, KT4A) to the 22kV switchgears and 22kV Load break switch for water supply.
  - 1.4.5 The connection of 230kV GIS air bushings and 115kV GIS air bushings to 230kV & 115kV overhead lines.
  - 1.4.6 The connection of 22kV switchgears to 22kV PEA lines and 22kV Camp area lines.
  - 1.4.7 The grounding equipment and miscellaneous hardware for the 200MVA 230/115-22kV auto-transformers (KT1A, KT2A) and 25MVA, 115/22kV power transformers (KT3A, KT4A).
- 1.5 To meet EGAT's service continuity requirements, the GIS gas compartment can be designed as indicated in the single line diagram or can be designed differently under a condition that the design of the gas compartment shall fulfill the requirements as specified in the specification.
- 1.6 Supply and installation of the marking pins for the referenced positions from the main bus shall be provided in the GIS building. The positions of the marking pins shall be shown on the drawings for future GIS extension and the quantity shall not be less than 4 sets. The making pins shall be made of brass or stainless steel that have the formation as follows:

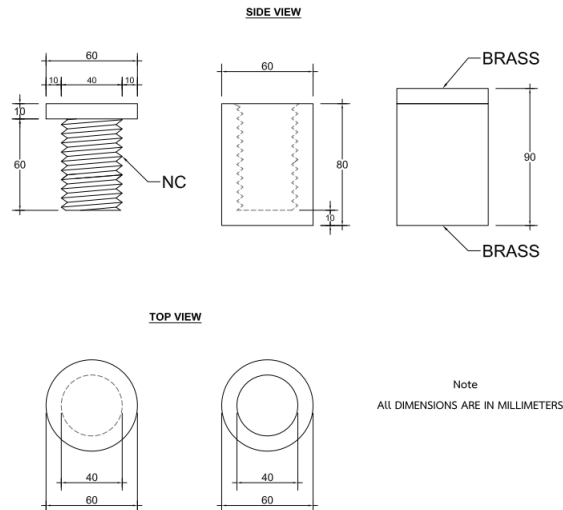

- 1.7 The detachable walk way (cat walk) for visual inspection shall be properly installed on each GIS module and removable service platform, removable ladder shall be provided for GIS inspection.
- 1.8 The contractor shall supply the cart for transporting the equipment from the loading area to the 230kV GIS room for construction and maintenance.
- 1.9 The feeder nameplates as well as phasing, device and switching numbers shown on the GIS module shall be painted or mounted (detachable type) on the enclosure of GIS whichever is appropriate according to the instruction from EGAT GIS installation team.
- 1.10 The contractor shall supply identification plates for the both indoor and outdoor substation. The material, size and color shall be as shown on attached drawings except size of GIS identification plates shall be proposed by the contractor and approved by EGAT.
- 1.11 The sag and tension of phase wires and overhead ground wires shall be calculated and designed according to internationally-accepted standards by the contractor and the said calculation shall be submitted to EGAT for approval.
- 1.12 Design, supply and installation of 115kV XLPE cable system which comprises at least the following:
  - 1.12.1 The design and calculation of the 115kV cable system shall conform to IEC and/or IEEE standards.
  - 1.12.2 The 115kV XLPE cable shall be single-core with copper conductor.
  - 1.12.3 Design, supply and installation of the 115kV XLPE cables in an 115kV system complete from one end at the 115kV GIS to the other end, including cable trench, cable supporting structures, cable spacers, cable cleats, cable riser supporting structure, cable termination, miscellaneous hardware, link box, Sheath Voltage Limiter (SVL) (if applicable) and all related equipment, structures and hardware.
  - 1.12.4 The 115kV XLPE cable shall be installed in flat formation. The cable supporting structure shall be made of stainless steel, aluminum alloy or

galvanized steel. The contractor shall design, supply and install the cable supporting structures that are suitable for cable cleat and cable system installation, and their grounding.

- 1.12.5 The minimum bending radius of the 115 kV XLPE cable shall be checked by contractor for cable installation and cable trench design.
  - 1.12.6 The contractor shall design the 115kV cable system such that one (1) 1/C-800 Sq.mm. XLPE cable shall be able to carry the continuous current no less than 825A given that the ambient temperature is no less than 45°C and the effect of solar heat shall be considered. The other parameters used in the design shall be practical, reasonable, operational and conform to IEC or IEEE standards. The calculated continuous current rating shall be shown in the single-line diagram.
  - 1.12.7 The contractor shall calculate the sheath induced voltage in accordance with IEEE standard. The sheath standing voltage at every point on the metallic sheath of 115kV XLPE cable system shall be less than 60V under the rated continuous current. The cable jacket shall be properly designed to be protected from overvoltage. Determine the specification for a surge voltage limiter (SVL) and PGCC cable if deemed technically necessary. The design report shall be submitted to EGAT for approval.
  - 1.12.8 Calculate the mechanical force due to short-circuit current as per IEC standard. Determine the specification for cable cleats. For the calculation of forces caused by short-circuit currents, the peak short circuit current of 100kA shall be used. The design report shall be submitted to EGAT for approval.
  - 1.12.9 Design, supply and installation the equipment to protect the power cable from the surge and over-voltage.
  - 1.12.10 The abnormal condition which occurs from the design and installation of 115kV XLPE cables for example ferroresonance etc. shall be responsible by the Contractor.
  - 1.12.11 Based on the design of 115kV XLPE cable system aforementioned, the contractor shall provide detailed drawings for the installation of this cable system including all related components.
  - 1.12.12 The position and number of the cable cleats shall be calculated and determined by the contractor to withstand the electromechanical force from short circuit according to IEC standard. The cable cleats shall be metallic hot dip galvanized.
- 1.13 Design, supply and installation of 22kV XLPE cable system which comprises at least the following:
- 1.13.1 The design and calculation of the 22kV cable system shall conform to IEC and/or IEEE standards.

- 1.13.2 The 22kV XLPE cable shall be single-core with copper conductor.
- 1.13.3 Design, supply and installation of the 22kV XLPE cables in a 22kV system complete from one end at the 22kV bus to the 22kV switchgear, the 22kV load break switch, the station service transformers KW1A and KW2A and 22kV switchgear to the disconnecting switch, including cable trench, cable supporting structures, cable spacers, cable cleats, cable termination supporting structures, cable terminations, miscellaneous hardware, link box, Sheath Voltage Limiter (SVL) (if applicable) and all related equipment, structures and hardware.
- 1.13.4 The 22kV XLPE cable shall be installed in trefoil formation.

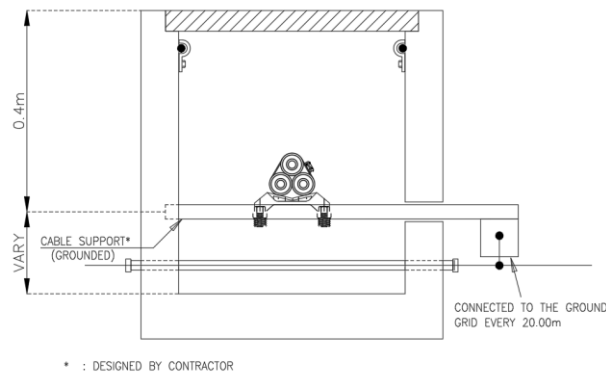

The cable support structure shall be made of stainless steel, aluminum alloy or galvanized steel. The contractor shall design, supply and install the cable supporting structures that are suitable for cable cleats and cable system installation and their grounding.

- 1.13.5 The minimum bending radius of the 22kV XLPE cable shall be checked by contractor for cable installation and cable trench design.
- 1.13.6 The contractor shall design the 22kV cable system such that one (1) 1/C-500 Sq.mm. and 1/C-35 Sq.mm. XLPE cable shall be able to carry the continuous current not less than 700A and 50A respectively given that the ambient temperature is no less than 45°C. The effect of solar radiation shall be considered if deemed technically necessary. The other parameters used in the design shall be practical, reasonable, operational and conform to IEC standard. The design report shall be submitted to EGAT for approval. The calculated continuous current rating shall be shown in the single-line diagram.
- 1.13.7 The contractor shall calculate the sheath induced voltage in accordance with IEEE standard. The sheath standing voltage at every point on the metallic sheath of 22kV XLPE cable system shall be less than 60V under the rated continuous current. The cable jacket shall be properly designed to be protected from overvoltage. Determine the specification for a surge voltage limiter (SVL) and PGCC cable if deemed technically necessary. The design report shall be submitted to EGAT for approval.

- 1.13.8 Calculate the mechanical force due to short-circuit current as per IEC standard. Determine the specification for cable cleats. For the calculation of forces caused by short-circuit currents, the peak short circuit current of 62.5kA shall be used. The design report shall be submitted to EGAT for approval.
- 1.13.9 Design, supply and installation the equipment to protect the power cable from the surge and over-voltage.
- 1.13.10 The abnormal condition which occurs from the design and installation of the 22kV XLPE cable system for example the Ferro resonance etc, shall be responsible for the contractor.
- 1.13.11 Based on the design of 22kV XLPE cable system aforementioned, the contractor shall provide detailed drawings for the installation of this cable system including all related components.
- 1.13.12 The position and number of the cable cleats shall be calculated and determined by the contractor to withstand the electromechanical force from short circuit according to IEC standard. The cable cleats shall be metallic hot dip galvanized.

## **2. Station service system**

- 2.1 Design, supply and installation of station service system complete with integral accessories to provide a complete system operation. The station service system mainly consists of as follows:
  - 500kVA, 22,000-400/230V distribution transformer (KW1A)
  - 500kVA, 22,000-400/230V distribution transformer (KW2A)
  - Load Center Unit Substation (LCUS)
  - 22kV drop-out fuses
  - 22kV Load break switches
  - 600V, 800A safety switches
  - 22kV equipment, and AC&DC distribution boards, stationary batteries, battery chargers, power cables and all related equipment for the complete operation.
- 2.2 Design, supply and installation of equipment required for a complete 400/230V power supply system.
- 2.3 Design, supply and installation of the stationary battery, in which the battery is capable of delivering power to the control and protection for tripping all circuit breakers and emergency essential load for at least 8 hours if normal station service fails. The capacity of the battery shall be designed by the contractor which the considered factor the influence the capacity of battery shall be as follows:
  - The temperature correction factor is 1.0

- The design margin factor is 1.15
  - The aging factor is 1.25
- 2.4 In case of bus faults occurring on the last hour of battery power, the battery shall generate sufficient power for tripping all circuit breakers as shown in figure below. The stationary battery shall be designed and calculated in accordance with IEEE or other acceptable international standards. In addition, the size of the stationary battery shall be designed to support the operation of the new 230kV GIS and new 115kV GIS as shown on the attached bidding document drawings. The calculation shall be submitted to EGAT for approval. The size of battery shall not be less than 2,600Ah.

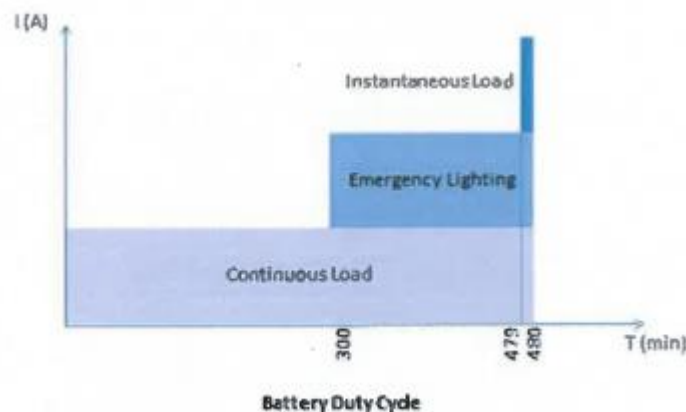

- 2.5 Emergency lighting system shall be installed at the control building, 230/115kV GIS building in case of normal station service fails. The said emergency lighting system is activated and capable of generating illumination level of at least 150 LUX for at least 3 hours.

### 3. Grounding system

- 3.1 Design, supply and installation the grounding system of 230kV GIS and 115kV GIS substation grounding system including the grounding system of 230/115kV GIS building and 22kV system
- 3.2 The grounding conductor of the substation grounding system shall be 4/0 AWG bare copper wire type.
- 3.3 The ground grid conductor spacing under the building area shall be the same as the switchyard.
- 3.4 Design, supply and installation of the grounding equipment and miscellaneous hardware for 230/115/22kV system including the 22kV power supply system and 115/22kV XLPE cable system.
- 3.5 The contractor shall evaluate the price of ground grid for the additional area based on the specified design for price reference as below:
- 3.5.1 The maximum ground grid conductor spacing (D0) shall be 3 meters.
  - 3.5.2 The number of ground rod shall be 100 pieces.

- 3.6 The contractor shall conduct the soil resistivity measurement. The result shall be submitted to EGAT for approval.
- 3.7 The contractor shall design a grounding grid based on the measured soil resistivity by hand calculation using the equations in IEEE-80 standard and submitted to EGAT for approval. The parameters for grounding system calculation shall be used as follows;
- Fault current division factor ( $s_f$ ) value = 1
  - Fault current (rms) = 40 kA
  - Time duration of fault = 1 second

These parameters shall be used for determine the size of grounding conductor for the substation grounding system. If the ground conductor spacing calculated by hand ( $D_1$ ) is less than the grounding conductor spacing for reference ( $D_0$ ), the contractor shall design a grounding grid by using the software. The certification of software shall be acceptable for commercial use.

#### **4. Lightning protection system**

- 4.1 Design, supply and installation of the substation lightning protection system complete with all related equipment. The contractor shall design the lightning protection system for the protection of all substation equipment which is under the protective zone. To meet EGAT's design criteria for the lightning protection system and to enhance the stability of lightning protection system, the Basic Insulation Level voltage (BIL) of:

- a) 900kV for 230kV substation.
- b) 550kV for 115kV substation.

shall be used in calculation instead of Critical Flashover voltage (CFO).

For 22kV substation, the stroke current of 2kA shall be used for the calculation.

- 4.2 For the design of lightning protection system for the control building and GIS buildings, the lightning protection level (LPL) shall be used level 1 for calculation and the overhead ground wire is not permitted. Air terminal rods installed at the roof shall be used instead.
- 4.3 Lightning protection system shall be designed to meet IEC, NEMA and E.I.T. standards or internationally-accepted standards.

#### **5. Facility system**

##### **5.1 Outdoor facility system**

- 5.1.1 Design, supply and installation of a substation lighting system complete with all integral accessories to provide a complete system operation. The lighting system shall mainly consist of equipment lighting, fence lighting, access road lighting, power box (PRB), sign board lighting,

lighting relay panels (LRP), raceways and wiring cables for lighting circuits.

5.1.2 The lamps for outdoor facility lighting system shall be LED type with all integral accessories, e.g. lamp holders, fixtures, reflectors, and etc. The contractor shall provide drawings that show details for installation.

5.1.3 Design, supply and installation of circuits for remote control and door phone system of the entrance gate. The control of the entrance gate shall be operated in both manual and remote-control modes which shall be controlled from both the control room and the guardhouse.

## 5.2 Indoor facility system

5.2.1 Design, supply and installation of the facility system which mainly consists of power supply, lighting system, lightning protection system, grounding system, power supply, fire alarm and protection system, air conditioning system, ventilation system and telephone & LAN system in the 230/115kV GIS buildings. All cable wiring systems shall conform NEC and IEC standards or accepted international standards.

5.2.2 The lamps for indoor facility lighting system shall be LED type with all integral accessories, e.g. lamp holders, fixtures, reflectors, and etc. The contractor shall provide drawings that show details for installation and specify the LED lamp and LED luminaire circuit identified that the LED lamp circuit shall be supplied by 2 - 3 manufacturers.

5.2.3 All steel accessories e.g. lip-channel, conduit, conduit fittings, conduit accessories, box and cover shall be hot dip galvanized.

5.3 The size of low voltage cable shall be sufficient to keep the voltage drop at the load point less than 5% at rated current.

5.4 The voltage drops from the safety switch to the AC boards and from the AC boards to the load shall not exceed 3% and 2% respectively.

5.5 The voltage drop shall conform to EGAT's requirement and the calculation shall be submitted for approval.

## 6. Telecommunication system

6.1 Design, supply and installation of the telecommunication tower and cable ladder for telecommunication system by modifying the TELECOMMUNICATION TOWER "WSA" TYPE as shown in Dwg.No. UWC-06-WSA-501, 502, 503 & 504 The said tower shall be constructed and divided into appropriate portions which are painted white and orange alternately with the top and bottom portions being painted orange. The obstruction lighting system shall be controlled by automatic flash box (AFB) that gives 30-60 flashes per minute. The AFB shall be turned on and turned off by a photo-light switch. The lightning protection for the telecommunication tower shall be calculated and designed by the contractor and the said calculation shall be submitted to EGAT for approval.



## **7. Other work**

- 7.1 Supply and Installation of miscellaneous hardware required for suspension and post insulators assembly.
- 7.2 Relocation of the line trap (wave trap) TY1A and TY4A from the existing Bhumibol substation to the new Bhumibol substation. Details of relocation are shown on the bidding document drawing.
- 7.3 Modification of junction box supporting structure (JB001) for the installation of safety switches.
- 7.4 Modification of junction box supporting structure (JB003) for the installation of outdoor receptacle box (ORB1 and ORB3).
- 7.5 Modification of BS202 for installation of 22kV XLPE cables and 22kV power fuses.
- 7.6 Modification of DP401 for installation of 22kV XLPE cables and 22kV disconnecting switches.
- 7.7 Design, supply and installation of cabling from the outdoor marshalling cubical (MC002) to the associated equipment.

## **8. Testing and commissioning**

- 8.1 Testing and commissioning of all equipment required to make the substation function properly.

### **Work not included in this Contract**

The Work not included in this contract shall be as shown on the drawings and as follows:

1. Supply and installation of 230/115-22kV auto-transformers “KT1A, KT2A”
2. Supply and installation of 115-22kV power transformers “KT3A, KT4A”
3. The stringing work for the connection between the 230kV and 115kV substations take-off structures and the dead-end towers of the transmission lines.
4. Supply station post and suspension insulators.

# **CONTROL AND PROTECTION PART**

## **Schedule 1: 230 kV Bhumibol Substation (GIS)**

### **Work included in this Contract.**

1. Design, supply, installation, wiring, test and commissioning of complete control and protection system based on the IEC 61850 standard which comprises at least the following equipment:

#### For Process Level

- Merging Unit Cabinet
- 400/230 VAC, 125VDC power panel and distribution boards

#### For Bay Level

- Swing rack type Protective IED panel
- Swing-Rack type Bay Control Unit Panel
- Ethernet Switch Panel for Process Bus
- Ethernet Switch Panel for Station Bus
- E1 Converter Panel
- Metering Panel
- 400/230 VAC, 125VDC power panel and distribution boards
- Fault Recording System

#### For Station Level

- Outdoor antenna, GPS and Gateway panel
- HMI Server and accessories
- Engineering Workstation and accessories
- Substation Gateway and accessories
- Redundant UPS to power HMI Server and Engineering Workstation
- Operator Console set with chair
- 400/230 VAC, 125VDC power panel and distribution boards

#### For Loose part

- Optical fiber cables, Copper cables, Patch cord cables and accessories as well as connection of cables among all of the boards and the associated equipment in order to complete the function of the control and protection system.
- Loose equipment as specified in price schedule.

2. Design, supply, installation, wiring, test and commissioning of operator and engineering workstation, HMI data servers, gateways and all system software and

hardware required to run the IEC 61850 based substation protection and automation system along with the existing EGAT's SCADA.

3. Scope of work for System Integrator (SI) to design complete digital substation protection and automation system
  - SI shall design a complete digital substation protection and automation system as well as communication network based on the IEC 61850 standard to coordinate with equipment provided by EGAT.
  - SI shall configure each IED and communication network to fulfill the designed digital substation protection and automation system.
  - SI shall design engineering workstation, HMI data servers, gateways and all system software required to run the IEC 61850 based substation protection and automation system along with the existing EGAT's SCADA. Signal list for data to be displayed on HMI and sent to NCC/RCC shall be discussed with EGAT.
4. Providing complete schematic and wiring diagrams in both hardcopy and electronic file of the digital substation protection and automation system including programmable logic schemes of each IED, programmable logic schemes of parallel Transformer, HMI graphic display, SSD files, ICD files, SCD files, CID files, signal list of all SV, GOOSE and MMS and communication network connection diagram. Furthermore, software needed for the mentioned SCL file configuration shall be provided as well. Regarding the SCD file configuration, the software shall support multi-vendor IEDs and cover at least all IED manufacturers included in substation.

Remark :

- a. The Digital Substation System Network Topology on Drawing No. TP-E-20.3 are used as a guideline. The said drawing can be modified by the Contractor; however, it shall be submitted to EGAT for approval.
5. Contractor shall provide the draftsman working at site during the commissioning stage in order to be in charge of writing the As-built Drawings of Control and Protection System.

## **Schedule 2: 115 kV Bhumibol Substation (GIS)**

### **Work included in this Contract.**

1. Design, supply, installation, wiring, test and commissioning of complete control and protection system based on the IEC 61850 standard which comprises at least the following equipment:

For Process Level

- Merging Unit Cabinet
- 400/230 VAC, 125VDC power panel and distribution boards

For Bay Level

- Swing rack type Protective IED panel
- Swing-Rack type Bay Control Unit Panel
- Ethernet Switch Panel for Process Bus
- Ethernet Switch Panel for Station Bus
- E1 Converter Panel
- Metering Panel
- 400/230 VAC, 125VDC power panel and distribution boards
- Fault Recording System

For Station Level

- Outdoor antenna, GPS and Gateway panel
- HMI Server and accessories
- Engineering Workstation and accessories
- Substation Gateway and accessories
- Redundant UPS to power HMI Server and Engineering Workstation
- Operator Console set with chair
- 400/230 VAC, 125VDC power panel and distribution boards

For Loose part

- Fiber optic cables, Copper cables, Patch cord and accessories as well as connection of cables among all of the boards and the associated equipment in order to complete the function of the control and protection system.
- loose equipment as specified in price schedule.

2. Design, supply, installation, wiring, test and commissioning of operator and engineering workstation, HMI data servers, gateways and all system software and hardware required to run the IEC 61850 based substation protection and automation system along with the existing EGAT's SCADA.
3. Scope of work for System Integrator (SI) to design complete digital substation protection and automation system
  - SI shall design a complete digital substation protection and automation system as well as communication network based on the IEC 61850 standard to coordinate with equipment provided by EGAT.
  - SI shall configure each IED and communication network to fulfill the designed digital substation protection and automation system.
  - SI shall design engineering workstation, HMI data servers, gateways and all system software required to run the IEC 61850 based substation protection and automation system along with the existing EGAT's SCADA. Signal list for data to be displayed on HMI and sent to NCC/RCC shall be discussed with EGAT.

4. Providing complete schematic and wiring diagrams in both hardcopy and electronic file of the digital substation protection and automation system including programmable logic schemes of each IED, programmable logic schemes of parallel Transformer, HMI graphic display, SSD files, ICD files, SCD files, CID files, signal list of all SV, GOOSE and MMS and communication network connection diagram. Furthermore, software needed for the mentioned SCL file configuration shall be provided as well. Regarding the SCD file configuration, the software shall support multi-vendor IEDs and cover at least all IED manufacturers included in substation.

Remark :

- a. The Digital Substation System Network Topology on Drawing No. TP-E-20.3 are used as a guideline. The said drawing can be modified by the Contractor; however, it shall be submitted to EGAT for approval.
5. Contractor shall provide the draftsman working at site during the commissioning stage in order to be in charge of writing the As-built Drawings of Control and Protection System.

## **CIVIL AND ARCHITECTURAL PART**

### **Schedule 1&2: 230/115 kV Bhumibol Substation (GIS)**

#### **Work included in this Contract.**

#### **Architectural work**

#### **1. Design and Construction of**

##### **1.1 230/115 kV GIS Building.**

- 1.1.1 Structure & foundation. The proper structure can be selected for the design and construction and shall be submitted to EGAT for approval.
- 1.1.2 RC and/or steel structure for roof.
- 1.1.3 Fire protection for steel structure shall conform to legal provision, EGAT's specifications and Design manual for substation.
- 1.1.4 Architectural of the whole building.
- 1.1.5 The contractor shall construct the building conformed to "IEEE STD- 979-1994 (R2004)" (IEEE Guide for Substation Fire Protection)
- 1.1.6 230/115 kV GIS Building shall be designed with reference to Bhumibol Substation (Dwg.No.BB-GIS-8-01A) Equipment layouts and cable block out shall conform to electrical drawing Dwg.no.SE-GIS-0-01-01/01 and Dwg.No.BB-S-2 and Dwg.No.BB-S-6. Other facilities layouts shall conform to requirements with reference to architectural drawings and scope of work.
- 1.1.7 The design of building shall analyze and take the following aspects into consideration: Site, Environment, Context, Function, Climate (sunlight, wind, rain, heat etc.), Energy efficiency, Safety and including aesthetic of architecture to encourage EGAT corporate identity.
- 1.1.8 Building facilities
  - Electricity and illumination system including cable work for illumination, ventilation system, power supply, and telephone system.
  - Storm water drainage system.
  - Miscellaneous including grounding and labeling.
  - Cable routing and cable support (cable tray and cable ladder) installed in main cable trench.
  - Overhead traveling crane, of lifting capacity not less than 7.5 and 5 metric tons and wireless crane remote control. Overhead traveling crane shall have cat-walk for maintenance the equipment on ceiling and complete with 2 sides of guard rail along the cat-walk.

- Overhead traveling crane shall comply with standard DIN EN 15011 standard.
- Overhead traveling crane motors shall be dual speed or inverter and have operation speed as below.

Operating speed	High speed	Low speed
Cross travel	20 m/min	5 m/min
Long travel	32 m/min	5 m/min
Lifting	5 m/min	0.8 m/min

- Overhead traveling crane shall be inspected and maintained for 2 years, not less than 4 times per year and not less than manufacturers' recommendation.
- Furniture as specified in architectural drawings.
- Signboard on building.
- Warning sign provided in accordance with EIT Standard or Quality and Safety Development Division Standard (EGAT).
- Lightning protection system.
- Emergency lighting system.
- The access floor system material in the Specification No.3001 (Civil and Architectural work) No.3001-10.8.3.5 Access Floor System (Raised Flooring System) shall be cancelled.

#### 1.1.9 3D Animation Specification

##### (1) 3D Animation Requirement

- a) A video of walk-through substation 3D animation. The video shall be not less than 3 minutes length, the resolution shall be not less than 4K (3840 x2163 pixels) with a frame rate of 60 fps, have an MP4 H.264 file type. The video shall also show these details.
  - Substation's name, in both Thai and English
  - A clear view of substation's entrance and signboard
  - Normal-eye-view (normal perspective) exterior scenes of the whole substation, including every building and electrical equipment
  - Bird 's-eye-view exterior scenes of the whole substation, including every building and electrical equipment

- Normal-eye-view (normal perspective) interior scenes of every building in the substation, such as control room, GIS area, electrical room, relay room, switchgear room, etc.
- Bird 's-eye-view interior scenes of GIS area, and any other rooms

b) All relate 3D files used to create the 3D animation, both in their respective original file types and being exported as SketchUp (SKP) files

(2) 3D Animation Video Specification

- a) The contractor shall make use of any software with a software copyrights.
- b) A music, which is not subjected to copyrights, shall be added into the 3D animation.
- c) The contour, landscape and surrounding of the substation in the 3D animation shall also be created, based on the real existing surrounding.
- d) A model used to create the 3D animation shall follow these details:
  - Any components with a size of 0.008 cubic meters, or more, shall be created as a 3D model
  - All models shall be texture-mapped, with a color and texture close to the real surface of the material, equipment, or building they are based on.
  - The 3D animation shall make use of the renderings systems along with the ray tracing system to create a realistic light, in accordance to the real sun positioning in Thailand.

1.1.10 For exterior surface of the building, there shall be at least 20% of total building area which uses yellow color that represents corporate image of EGAT.

**Civil Work**

2. Design and construction of

2.1 230/115 kV GIS Building.

2.1.1 Floor loading as shown on specification 3001-10.1.2 shall be changed to the new details as following:

- Control and communication room 1,250 kg/sq.m



- Removable raised floor 1,700 kg/sq.m
- Station battery room 1,600 kg/sq.m
- Platform area for Control, Communication & Electrical 1,700 kg/sq.m
- Electrical room 1,700 kg/sq.m

(Bidders are required to use floor load in accordance with the actual equipment load for Control and communication room, Removable raised floor for control room and electrical room, Station battery room, Platform area for Communication & Electrical and Electrical room. And floor load shall not be less than the minimum floor loading that specified by EGAT

- 2.2 Steel structure and foundations for Specified equipment and the others not shown in “For Construction drawings” and / or EGAT’s specification.
- 2.3 Road and drainage system.
- 2.4 Drainage system for cable trench.
- 2.5 Oil containing pit with steel grating and black steel spiral-seam pipes (TIS 427-2531) with protection method according to AWWA C217, C205. (Design sizing for oil drain system only)
- 2.6 Remote control (shall be controlled from either the control room or the guard house) and door phone system for main entrance gate.
- 2.7 Take-off with fire wall foundation (fire wall conformed to NFPA 850)
- 2.8 22kV Dead end structure foundation
- 2.9 Telecommunication tower foundation.
- 2.10 Cable trench type A and B with RC. cover for 115 kV XLPE system.
- 2.11 Water supply system.
- 3. Construction of
  - 3.1 Steel structure foundation.
  - 3.2 Take-off foundation.
  - 3.3 Equipment structure foundation with sub trench (if required).
  - 3.4 Transformer loading.
  - 3.5 Cable trench.

- 3.6 RC. Road.
  - 3.7 Oil separator.
  - 3.8 Oil containing pit with steel grating and black steel spiral-seam pipes (TIS 427-2531) with protection method according to AWWA C217, C205.
  - 3.9 Fire wall.
  - 3.10 Crushed rock surfacing.
  - 3.11 Concrete fence.
  - 3.12 Main entrance gate 8.00 m width (sliding).
  - 3.13 Signboard structure and foundation.
  - 3.14 Transformer foundation with oil containing pit.
  - 3.15 Site office
  - 3.16 Guard house.
  - 3.17 Garage house
  - 3.18 Flag pole.
  - 3.19 Fence with lighting support on fence.
4. The drawings and calculation of all buildings shall be verified with adequate details for intended application and submitted to EGAT for approval.
  5. All design works and the fabrication drawings for all steel structures shall be submitted to EGAT for approval.
  6. All design, construction and testing shall be in accordance with Specification No.3001 : Civil and Architectural Work.
  7. Bored hole for soil investigation shall conform to Specification No. 3001. The position shall be submitted to EGAT for approval.
  8. EGAT's Soil Investigation Report (attached to the Contract) is a document that can be a reference for design, however; the review of the soil investigation report shall be under responsibility of the Contractor and the warranty of work shall remain following all obligations as specified in the Contract.
  9. In case of soil layer is soft clay, consolidation test shall be performed from clay of one bored hole only. The position shall be submitted to EGAT for approval.

10. All foundations shall be as specified in layout drawing. Except the result of soil investigation shows that the specified foundations are not appropriate, the Contractor shall design the proposed foundations.
11. The Contractor shall perform a static load test for 230/115kV GIS Building foundations in accordance with ASTM D1143 (if pile type foundation is required).
12. Dynamic load test (DLT) according to ASTM D4945-89 shall be applied to at least 2% of driven piles (if driven pile type is required) except for driven pile of fence and lamp post.
13. Seismic load test (sonic integrity test) according to ASTM D5882-96 shall be applied to all bored piles (if bored pile type is required).
14. Plate bearing test according to ASTM D1194-94 shall be submitted to EGAT for approval.(if pad type foundation is required).
15. The Contractor shall remove all debris from construction material and other works in order to make the site clean and be in the condition acceptable to EGAT.
16. According to the Contract Document Section G-3 : Contractor's Office and Other Construction Facilities; the detail in paragraph 3 shall be changed as follows : the Contractor shall provide for EGAT an office container at the site during construction with a minimum space of 36 sq.m for office area, 24 sq.m for conference room which shall both be air-conditioned and 4 sq.m for toilet. The facilities as shown on the section G-3 are required for 1 set.
17. Site preparation
  - 17.1 The preparation of the area to be covered by crushed rock surfacing and GIS building area shall be done by contractor in such a way as stripping top soil shall not less than 0.30 m and remove all objectionable materials and shall not be used for embankment.
  - 17.2 Embankment the soil to the level of +144.10 to +144.20 m and shall be compacted to 85% standard proctor density on each later (0.20 m) except last layer (0.15 m) shall be compacted 95% standard proctor density.
  - 17.3 Existing to be removed.
    - 17.3.1 RC. Road
    - 17.3.2 Wire mesh fence

**Work not included in this Contract.**

1. Supply of spare grass&weed killer and accessories. (Specification 3001-4.2.4)

## **Schedule 3: 230/115 kV Bhumibol Substation (GIS) (Fire Protection System)**

### **Work included in this Contract.**

1. Design and construction of
  - 1.1 Fire protection system for 230/115 kV GIS Building.
    - 1.1.1 Control/Relay area shall consist of Total Flood Clean Agent Fire Suppression System with heat detector, addressable type smoke detector and aspirated smoke detector.
    - 1.1.2 GIS area shall consist of double-interlock pre-action water sprinkler system, optical beam smoke detector.
    - 1.1.3 Cable floor and cable room shall consist of Total Flood Clean Agent Fire Suppression System with addressable type smoke detector and aspirated smoke detector.
    - 1.1.4 Fire protection system of 230/115 kV GIS Building shall have trouble and operation visual and audible signals (environmental monitoring), which indicate change of state of any connected device, shown and recorded at control room in 230/115 kV GIS Building. The installation practice shall be in accordance with the last edition of NFPA 72.
    - 1.1.5 There shall be sounder and beacon on the roof of the building.
    - 1.1.6 For system requirements for indoor fire protection system as shown on specification 3001-10.13.1 part e, item no.1 and 6 shall be changed to the new details as follow
      - (1) System description and operation : Supply and Installation of a Total Flood Clean Agent Fire Suppression System utilizing IG-100 shall cover all these zones :
        - Zone 1: Equipment (Control/Relay) Room ;
        - Zone 2: Electrical Room ;
        - Zone 3: Under Raised Floor ;
        - Zone 4: Battery Room ;
        - Zone 5: Cable Room/Cable floor ;
        - Zone 6: Inert Gas Room
        - Other zone (If required)Each protected zone shall have its own set of IG-100 cylinders.System description and operation: Supply and Installation of an Automatic Water Sprinkler System shall cover all area of the building except the zone which is protected by IG-100 fire suppression system.

- (6) Detectors shall be cross-zoned detection requiring 2 detectors to be in alarm before discharge. A zone of A or B of addressable smoke detector and a zone C of all ASD shall be crossed.
- 1.1.7 For air sampling smoke detector as shown on specification 3001-10.13.2 part i item no.1, 7, 13 and 14 shall be changed to the new details as followings:
- i. Air Sampling Smoke Detector.
- (1) Shall consist of a high sensitivity type detector, using light scatter technology.
- (7) Detection system for all cabinet shall be omitted.
- (13) The minimum sensitivity settings for a single sampling hole are so that the detection system alarm at 1.5%obs/ft(4.95%obs/m).A sampling hole maximum coverage area is 400.0 sq.ft(37.2 sq.m).
- (14) Maximum transport time from the most remote port to the detection unit of an air-sampling system shall be a maximum of 90 seconds.
- 1.1.8 Fire protection system, fire alarm system, installation room and accessories shall be in accordance with the applicable requirements set forth in the latest edition of the following codes and standards:
- NFPA 2001: Clean Agent Fire Extinguishing Systems
  - NFPA 13 : Standard for the Installation of Sprinkler Systems
  - NFPA 14 : Standard for the Installation of Standpipe and Hose Systems
  - NFPA 70 : National Electrical Code.
  - NFPA 72 : National Fire Alarm Code.
  - NFPA 75 : Standard for the Fire Protection of Information Technology Equipment.
  - NFPA 76 : Standard for the Fire Protection of Telecommunications Facilities.
  - IEEE Std 979: IEEE Guide for Substation Fire Protection
  - NFPA 850: Recommended Practice for Fire Protection for Electric Generating Plants and High Voltage Direct Current Converter Substations.
- 1.1.9 There shall be one control panel which controls fire detection system and IG-100 fire suppression system in the building.
- 1.1.10 There shall be a protective clear polycarbonate cover which can be immediately lifted or opened for all IG-100 manual release stations.
- 1.1.11 Battery room shall be furnished with an all-stainless steel, wall-mounted emergency eyewash. Contractor shall submit the catalog and proposed location of the eyewash to EGAT for approval.
- 1.1.12 The building fire protection system shall consist of standpipe and hose system.

- 1.1.13 The automatic water sprinkler system for GIS area shall be double-interlock pre-action system.
- 1.1.14 The automatic water sprinkler system discharge signal shall be able to determine the zone or room of discharged sprinkler.
- 1.1.15 The automatic water sprinkler system shall be conformed to local law and design standards.
- 1.1.16 There shall be fire department connection for automatic sprinkler system for the GIS building.
- 1.2 Fire protection system for the switchyard to meet the requirement as specified in IEEE Guide for Substation Fire Protection: IEEE Std 979, all requirements of NFPA 850.
- 1.3 Fire protection system for the Transformer: The Foam-water spray system shall comply with the following;
  - 1.3.1 Foam-water spray system: NFPA 13, NFPA16 & NFPA 850
  - 1.3.2 Bladder tank vessel construction standards : Carbon steel to ASME code section VIII for unfired pressure vessel.
  - 1.3.3 Nozzles : NFPA 16 and as per Manufacturer's Recommendation
  - 1.3.4 Detection system : Air Expansion Linear Heat Detection System (LHB)
  - 1.3.5 Equipment for system : FM approved, UL Listings , Vds
  - 1.3.6 Foam-water spray system provided for Transformer shall be designed for a density of 10.2 litre/min-sq.m over the exposed surface at the Transformer.
  - 1.3.7 There shall be one linear heat detector box for each transformer.
  - 1.3.8 There shall be one control panel for fire detection and foam/water spray system which controls all foam/water spray system of all protected transformers.
- 1.4 Fire Pump System. (conforming to NFPA 14, 20, 22, 24, 72).
- 1.5 250 cu.m water storage tank, fire pump, and jockey pump shall have trouble and operation visual and audible signals (environmental monitoring), which indicate change of state of any connected devices, shown and recorded at control room in 230/115 kV GIS Building. The installation practice shall be in accordance with the latest edition of NFPA 72.
- 1.6 There shall be one fire alarm system graphic annunciator at each building to enable responding personnel to identify the location of a fire accurately and to indicate the status of emergency equipment or fire safety functions
- 1.7 There shall be one graphic annunciator which displays alarm, discharge and trouble signals of fire alarm system of other buildings, (fire pump houses, transformers, shunt reactors) at the building where control room locates.

- 1.8 Fire protection system circuits for buildings and switchyards : notification appliance circuits , and signaling line circuits , shall be class A circuit. Initiating device circuits can be class B circuit.
- 1.9 For Control System Logic as shown on specification 3001-13.4 item 4.1 shall be changed to the new detail as following

(4.1) In case of fire, heat detector and the tubular expansion detector first give alarm. If rate of rise/fixed temp in heat detector/tubular expansion detector sense fire condition, there shall be alarm in control room and the detected transformer shall be tripped before applying Foam-Water spray as the condition shown in the diagram below ;

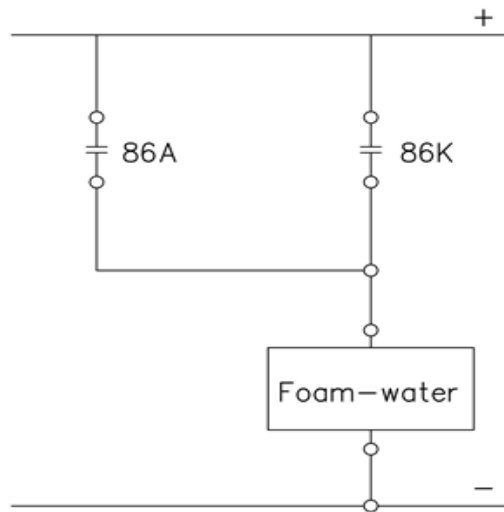

- 1.10 Signals of indoor fire protection system of each room and signals of outdoor fire protection system of each transformer shall be sent to local CCS, GCC, RCC, and NCC as following details;

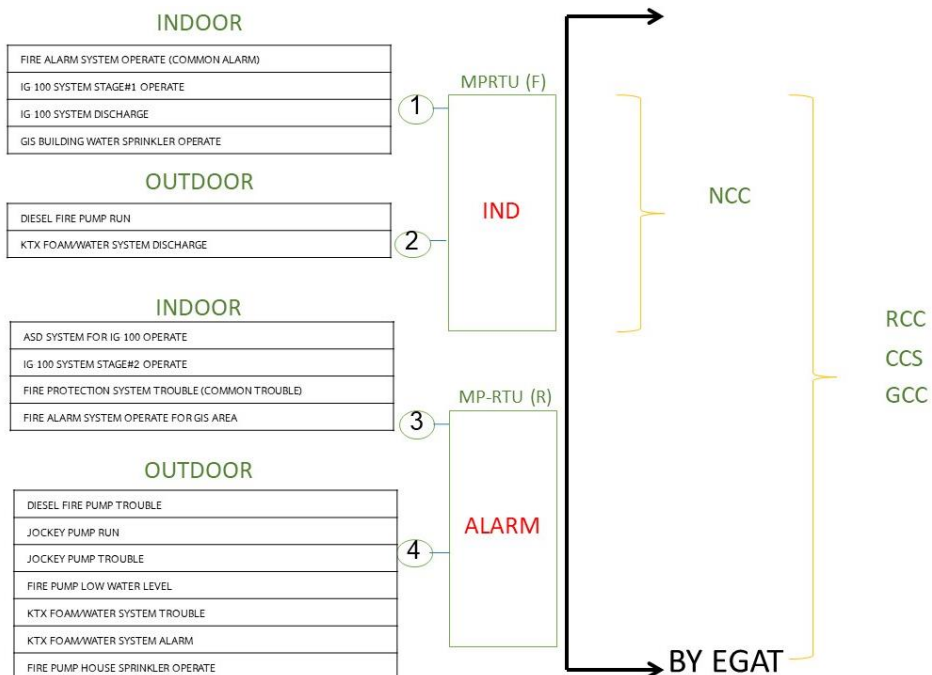

- 1.11 There shall be only one subcontractor engaging in design, supply and installation of Fire Protection System for Buildings and Switchyard.
- 1.12 All building wall openings for fire protection dampers shall be provided with stainless steel louvers and insect screens to install inside of building.
- 1.13 For portable fire extinguisher as shown on specification 3001- 10.13.3 shall be changed to the new details as followings:
- The fire extinguishers shall be conformed to latest TIS standards. The portable and mobile fire extinguishers shall be carbon dioxide (CO2) conforming to TIS 881 and/or dry chemical conforming to TIS 332, capacity 10 lbs/set. The fitting accessories shall be provided.
  - The portable fire extinguishers shall be installed according to the latest NFPA 10.
- 1.14 There shall be safety signs for fire extinguisher, manual release station and fire alarm device.
- 1.15 Fire protection system work shall be inspected and maintained for 2 years, not less than 4 times per year and not less than manufacturers' recommendation.
- 1.16 There shall be a set of computer desk with chair, a set of CPU which suitable for fire protection system software and operate 24 hours a day and a set of 24" LED monitor which show the status of fire protection system in control room in 230/115 kV GIS Building. One set of laser jet printer shall be provided.
- 1.17 Consumable materials for fire protection system, for example, filters, liquids, and seals shall be provided according to manufacturer's instructions for a period of two years.
- 1.18 For all buildings, piping or cable penetrating the wall/floor and block out at wall/floor shall be enclosed with fire stop material. Fire stop material shall be approved by UL Listed/FM Approved and comply with NFPA 80 (Standard for Fire Doors and Other Opening Protectives) and other relevant standards. The installer shall be certified by manufacturer and have experience in installation of material for at least 5 years, of at least 10 projects.
- 1.19 Fire detection devices in substation shall be as table below.

Protected Area	Detector
1. Control, Relay and Telecommunication Rooms	ASD and SD
2. Under-Raised Floor	ASD and SD
3. Feeder Sections and Switchgear areas	ASD and SD
4. Electrical Room	ASD and SD
5. Battery room	



5.1 Battery room Vented Type	HD
5.2 Battery room Dry Type	HD
6. GIS Area	OBSD
7. Inert Gas Room	SD
8. Other Room such as Shops, Office, Warehouse and Pantry	HD or SD
9. Emergency Diesel generator room or Emergency Generator Set House	HD
10. Transformer, Shunt Reactor	LHD
11. Cable Spreading Area/Rooms and Cable Tunnels	<ul style="list-style-type: none"> <li>▪ SD when environmental condition is acceptable.</li> <li>▪ LHD when environmental condition is out of range for SD</li> <li>▪ ASD in high risk area and required early response.</li> </ul>
12. Main Cable Trench of GIS Area	LHD

#### Abbreviations

1. Heat detector, HD
2. Addressable Spot-Type Photoelectric Smoke detector, SD
3. Linear Heat Detector, LHD
4. Aspirated smoke detectors, ASD
5. Optical beam smoke detector, OBSD

1.20 Pipe coating system shall conform to ASME A13.1 standard and ANSI-A13.1

1.21 Underground water piping shall have indicator sign.

1.22 For Fire protection system design shall be conformed to NFPA 101 (Life Safety Code).

#### 2. Construction of

2.1 Foam house.

2.2 Fire pump house.

2.3 Cabinets with 2x50 lbs. wheel fire extinguisher.

2.4 Water storage tank for fire protection system (capacity not less than 250 cu.m).

## **2. 230 KV BHUMIBOL DAM POWER PLANT SWITCHYARD**

### **GENERAL**

#### **Schedule 4: 230 kV Bhumibol Dam Power Plant Switchyard**

The existing 230 kV Bhumibol Dam Power Plant Switchyard shall be improved for the following:

- Bay 3 for 230 kV line to Tak 2 Substation
- Bay 5 for 230 kV line No.2 to Bhumibol Substation
- Bay 7 for 230 kV line No.1 to Bhumibol Substation

The Contractor shall supply equipment, perform construction and installation work necessary for completion of operation substation in accordance with the Contract Documents. The design work shall include, but not limited to, technical calculation, preparation of drawings, bill of materials for installation and construction work. For accomplishment of complete operational substation, Scope of Contractor's work shall include connection to all public utilities i.e. electrical power, water and drainage. Testing and commissioning of all equipment required to make the substation function properly.

Besides, all detailed engineering design work, calculations, drawing preparation, submission of backup data, test reports instruction books (and), etc. shall be included.

- 1) As stated elsewhere in this bidding documents, the drawings included in the bidding documents except drawing mark "For Construction" are for bidding purposes only and shall not be used for execution of the work.
- 2) The submitted drawings which are incomplete/unacceptable, or are the bidding document copies with minor modifications shall be returned unmarked to the Contractor.
- 3) The drawings shall be furnished which provide all details required for thoroughly described equipment as well as installation methods and requirements. However, EGAT retains the right to request additional details if those furnished are perceived inadequate.
- 4) Calculations, backup data and documentation are required for all parts of the design. The furnished data shall verify completely that design is adequate for application purpose.

## **CONTROL AND PROTECTION PART**

### **Schedule 4: 230 kV Bhumibol Dam Power Plant Switchyard**

#### **Work included in this Contract.**

1. Design, supply, installation, wiring, test and commissioning of complete control and protection system which comprises at least the following equipment.
  - Line Differential Relays (87L) for replacing Existing main Protective Relay in Panel nos. 20R and 23R.
  - E1 Converter Panel
  - Loose equipment as specified in price schedule.
  - Related accessory equipment which is required for interfacing between the existing equipment and new equipment.
  - Cable and accessories as well as connection of cables among all the new equipment, the existing panels and the associated equipment in order to complete the function of the control and protection system.
2. Design, modification, wiring, test and commissioning of the existing equipment which comprises at least the following equipment in order to incorporate the new equipment.
  - The existing panels such as 125VDC board, existing control and protection panels and Fault Recording System.
3. Design, modification of the schematic and wiring diagram of the additional and replacement inputs to the existing EGAT RTU, including test and commissioning of the complete EGAT RTU. Providing completed EGAT RTU I/O List in both hardcopy and electronic file.
4. Design and modification of the schematic and wiring diagrams of the additional inputs to the existing Fault Recording System (FRS), including wiring, configuration, calibration, test and commissioning of the completed FRS.
5. Rename Line from “230 KV LINE NO.1 TO TAK2” to “230KV. LINE NO.1 TO BHUMIBOL SUBSTATION”, “230KV. LINE TO BHUMIBOL SUBSTATION” to “230KV. LINE NO.2 TO BHUMIBOL SUBSTATION” and “230KV LINE NO.2 TO TAK2” to “230KV LINE TO TAK2” and Rename all related Existing Drawing and equipment in Panel Nos. 17F/17R, 20F/20R, 23F/23R and all related panel.
6. Any modification and interfacing works to the existing panels, including supply of related accessory equipment which is required for incorporating the new equipment. The modified existing drawings shall be modified by the Contractor and submitted to EGAT for approval. The final drawings shall be submitted as ACAD files.
7. The contractor shall be responsible for providing complete schematic and wiring diagrams of the control and protection systems.

8. Removal of the unused existing protection panel or unused equipment of existing control and protection panel. The removed protection panel shall be neatly kept in a suitable place recommended by EGAT.
9. Removal of the unused existing cables. The removed cable shall be neatly reeled and kept in a suitable place recommended by EGAT.
10. Contractor shall provide the draftsman working at site during the commissioning stage in order to be in charge of writing the As-built Drawings of Control and Protection System.

### **3. 230 KV TAK 2 SUBSTATION**

#### **GENERAL**

##### **Schedule 5: 230 kV Tak 2 Substation**

The existing 230 kV Tak 2 Substation shall be improved for the following:

- Bay 3 for 230 kV line to Bhumibol Dam Power Plant Switchyard
- Bay 9 for 230 kV line to Bhumibol Substation

The Contractor shall supply equipment, perform construction and installation work necessary for completion of operation substation in accordance with the Contract Documents. The design work shall include, but not limited to, technical calculation, preparation of drawings, bill of materials for installation and construction work. For accomplishment of complete operational substation, Scope of Contractor's work shall include connection to all public utilities i.e. electrical power, water and drainage. Testing and commissioning of all equipment required to make the substation function properly.

Besides, all detailed engineering design work, calculations, drawing preparation, submission of backup data, test reports instruction books (and), etc. shall be included.

- 1) As stated elsewhere in this bidding documents, the drawings included in the bidding documents except drawing mark "For Construction" are for bidding purposes only and shall not be used for execution of the work.
- 2) The submitted drawings which are incomplete/unacceptable, or are the bidding document copies with minor modifications shall be returned unmarked to the Contractor.
- 3) The drawings shall be furnished which provide all details required for thoroughly described equipment as well as installation methods and requirements. However, EGAT retains the right to request additional details if those furnished are perceived inadequate.
- 4) Calculations, backup data and documentation are required for all parts of the design. The furnished data shall verify completely that design is adequate for application purpose.

## **CONTROL AND PROTECTION PART**

### **Schedule 5: 230 kV TAK 2 Substation**

#### **Work included in this Contract.**

1. Design, supply, installation, wiring, test and commissioning of complete control and protection system which comprises at least the following equipment.
  - Line Differential Relay (87L) for replacing Existing Backup Relay (21BU) In Panel no. 1R
  - Loose equipment as specified in price schedule.
  - Related accessory equipment which is required for interfacing between the existing equipment and new equipment.
  - Cable and accessories as well as connection of cables among all the new equipment, the existing panels and the associated equipment in order to complete the function of the control and protection system.
2. Design, modification, wiring, test and commissioning of the existing equipment which comprises at least the following equipment in order to incorporate the new equipment.
  - The existing panels such as 125 VDC board, existing control and protection panels, marshalling panels, Interposing panel and Fault Recording System.
3. Design, modification of the schematic drawing, configuration of database and wiring diagram of the additional inputs for the existing EGAT CCS/RTU. The test and commissioning of the completed EGAT CCS/RTU shall be performed by the Contractor. The configuration shall be under EGAT's supervision.
4. Design, modification of the schematic and wiring diagram of the additional and replacement inputs to the existing Fault Recording System (FRS), including wiring, configuration, calibration, test and commissioning of the completed FRS.
5. Rename Line from "230KV. LINE NO.1 TO BHUMIBOL HYDRO POWER PLANT" to "230KV. LINE NO.1 TO BHUMIBOL SUBSTATION" and "230KV. LINE NO.2 TO BHUMIBOL POWER PLANT" to "230KV. LINE TO BHUMIBOL HYDRO POWER PLANT" and Rename all related Existing Drawing and equipment in Panel Nos. 1F/1R, 5F/5R, 24R, 25R and all related panel.
6. Any modification and interfacing works to the existing panels, including supply of related accessory equipment which is required for incorporating the new equipment. The modified existing drawings shall be modified by the Contractor and submitted to EGAT for approval. The final drawings shall be submitted as ACAD files.
7. The contractor shall be responsible for providing complete schematic and wiring diagrams of the control and protection systems.
8. Removal of the unused existing protection panel or unused equipment of existing control and protection panel. The removed protection panel shall be neatly kept in a suitable place recommended by EGAT.

9. Removal of the unused existing cables. The removed cable shall be neatly reeled and kept in a suitable place recommended by EGAT.
10. Contractor shall provide the draftsman working at site during the commissioning stage in order to be in charge of writing the As-built Drawings of Control and Protection System.