

EGAT's Privacy Notice on Procurement, Inventory Management and Contract Administration

Electricity Generating Authority of Thailand (EGAT) has performed the protection of the Personal Data regarding procurement, inventory management and contract administration to be in accordance with the **Personal Data Protection Act B.E. 2562** (the "2019 PDPA"), which comes into effect on June 1, 2022.

Details about EGAT's Privacy Notice on Procurement, Inventory Management and Contract Administration are available for you at https://www.egat.co.th/privacy-notice-procurement_en.html or the below QR Code.



The Redaction of Sensitive Personal Data

EGAT has announced the Privacy Notice on Procurement, Inventory Management and Contract Administration for the collection, use or disclosure of Personal Data, excluding the Sensitive Personal Data.

Should the documents you wish to submit to EGAT contain the Sensitive Personal Data as defined in Section 26 of the 2019 PDPA, pertaining to racial, ethnic origin, political opinions, cult, religious or philosophical beliefs, sexual behavior, criminal records, health data, disability, trade union information, genetic data, biometric data, or of any data which may affect you in the same manner, you shall redact or conceal such data before submitting to EGAT.

ประกาศความเป็นส่วนตัว (Privacy Notice) สำหรับการจัดซื้อจัดจ้าง การบริหารพัสดุ และการบริหารสัญญาของ กฟผ.

การไฟฟ้าฝ่ายผลิตแห่งประเทศไทย (กฟผ.) ได้ดำเนินการคุ้มครองข้อมูลส่วนบุคคลสำหรับการจัดซื้อจัดจ้าง การบริหารพัสดุ และการบริหารสัญญา เพื่อให้เป็นไปตามพระราชบัญญัติคุ้มครองข้อมูลส่วนบุคคลของประเทศไทย พ.ศ. 2562 (PDPA) ซึ่งมีผลบังคับใช้อย่างครบถ้วน ตั้งแต่วันที่ 1 มิถุนายน 2565 ทั้งนี้ ท่านสามารถศึกษารายละเอียดประกาศความเป็นส่วนตัว (Privacy Notice) สำหรับการจัดซื้อจัดจ้าง การบริหารพัสดุ และการบริหารสัญญา ได้ที่ <https://www.egat.co.th/privacy-notice-procurement.html> หรือที่ QR Code ด้านล่าง



การขิดฆ่าข้อมูลส่วนบุคคลอ่อนไหว

กฟผ. มีประกาศความเป็นส่วนตัว (Privacy Notice) สำหรับการจัดซื้อจัดจ้าง การบริหารพัสดุ และการบริหารสัญญา เพื่อใช้ในการเก็บรวบรวม ใช้ หรือเปิดเผย ข้อมูลส่วนบุคคล แต่ไม่เก็บข้อมูลส่วนบุคคลอ่อนไหว หากเอกสารของท่านที่ต้องส่งมอบให้ กฟผ. มีข้อมูลส่วนบุคคลอ่อนไหวตามที่ถูกบัญญัติไว้ในมาตรา 26 ของ PDPA ดังนี้ เชื้อชาติ เผ่าพันธุ์ ความคิดเห็นทางการเมือง ความเชื่อในลัทธิ ศาสนาหรือปรัชญา พฤติกรรมทางเพศ ประวัติอาชญากรรม ข้อมูลสุขภาพ ความพิการ ข้อมูลสหภาพแรงงาน ข้อมูลพันธุกรรม ข้อมูลชีวภาพ หรือข้อมูลอื่นใด ซึ่งกระทบต่อเจ้าของข้อมูลส่วนบุคคลในทำนองเดียวกันรวมอยู่ด้วย ขอให้ท่านขิดฆ่า หรือปกปิดข้อมูลดังกล่าว ก่อนส่งมอบให้แก่ กฟผ.

**1st Draft of Terms of Reference,
Announcement and Details of Medium Cost
for Invitation to Bid No. BBS1-SWG-01
Supply of 230 kV Compact Switchgear
Transmission System for Hydro-Floating Solar Hybrid Project Bhumibol Dam Unit 1**

The Electricity Generating Authority of Thailand (EGAT) plans to call for proposals for the subject Invitation to Bid. Any person who has the authorization from the company, firm, joint venture or consortium who supplies or manufactures the equipment required under the subject invitation to Bid is allowed to submit a comment against the first draft of the Terms of Reference (TOR), the Announcement and the Details of Medium Cost attached herewith.

How to Comment

Those who would like to comment shall submit an official letter signed by the authorized person(s) together with the letter of authorization or the power of attorney, and addressed to “Chief, International Procurement Department - Transmission Segment, Procurement and Inventory Management Division”.

Comments shall be submitted via EGAT Procurement website or via email address: pasakorn.piy@egat.co.th with all related documents attached (e.g. the letter of authorization and the power of attorney).

Comments shall be received by EGAT on or before **April 4, 2025**, Bangkok Standard Time, **otherwise the comments will not be taken into consideration.**

EGAT reserves the right to change or not to change the terms and conditions contained in the Terms of Reference, the Announcement and the Details of Medium Cost subject to its consideration and such decision shall be final.

Kanchanok Phoousaha

Miss Kanchanok Phoousaha
Head, International Buy Section - Transmission System Segment
April 1, 2025

Notice to Bidder

Subject : Online Payment for Purchase of Bidding Documents

Please be informed of the online payment for purchase of bidding documents as follows:

- 1) Download the Registration Form and fill out all necessary information by typing. (Complete data is required.)
- 2) Payment shall be made by bank transfer or telegraphic transfer to EGAT's account no. 109-6-01958-2 (swift code : KRTHTHBK), Krung Thai Bank Public Company Limited, Bangkruai Branch, Nonthaburi.

All bank charges and fees incurred by the payment of bidding documents shall be under the buyer's responsibility.

- 3) Submit the fill-out Registration Form and the proof of payment from 1) to the email address of the in-charge officer and procurement.tse@egat.co.th in the CC. before 15.00 hrs. Bangkok Standard Time.
- 4) After the payment has been verified for approximately 3 working days, the in-charge officer will send the link for downloading the bidding documents together with the receipt to the purchaser's email address in the Registration Form.



Invitation to Bid No. BBS1-SWG-01
Supply of 230 kV Compact Switchgear
Transmission System for Hydro-Floating Solar Hybrid Project Bhumibol Dam Unit 1

The Electricity Generating Authority of Thailand (EGAT) is calling for the subject Invitation to Bid to be financed by EGAT's fund. The project is on the process of the Government's Approval. The Bid may be cancelled in case the project is not approved.

Place of Delivery : Bangkok Port / Ex-works

Medium Cost (including Value Added Tax and other expenses) : THB 55,500,000.-

Eligibility of Bidders

1. The Bidder shall be a juristic person who manufactures or provides such materials or services and shall not be named in the List of Work Abandoners published by the Permanent Secretary, Ministry of Finance, and/or in the Debarment List and/or in the List of Work Abandoners declared by EGAT.
2. The Bidder shall not be a Jointly Interested Bidder with other Bidders as from the date of EGAT's issuance of the Invitation, or shall not be a person who undertakes any action as an "Obstruction of Fair Price Competition" for this Invitation.
3. The Bidder shall not either be EGAT's consultant or involve in EGAT's consultancy company under this Invitation to Bid, or shall not have EGAT's personnel involved in his business as shareholder having voting right that can control his business, director, manager, officer, employee, agent, or consultant except those who are officially ordered by EGAT to act or participate therein.
4. The Bidder shall not be the person who is privileged or protected not to be taken any legal proceedings under Thai Court; Provided that such Bidder's government declares that such special privilege is waived.
5. The Bidder who is a joint venture or consortium shall carry out all the work under such formation from the time of bidding until the fulfillment of the Contract.

Availability of Bidding Documents

Bidding Documents are available for online purchase during 8:00 hrs. to 15:00 hrs., Bangkok Standard Time, as from _____ to _____ at _____ or _____ per copy, non-refundable.

Please find more details for online purchasing process at <http://www4.egat.co.th/fprocurement/biddingeng> or contact for further information at telephone no. 66 2436 0341 or procurement.tse@egat.co.th.

Delivery of Bids

Bids shall be submitted at Bidding Room, 1st Floor, Tor 082 Building at EGAT's Head Office, Nonthaburi during 9:00 hrs. to 10:00 hrs., Bangkok Standard Time, _____ and will be opened publicly at 10:00 hrs.

ELECTRICITY GENERATING AUTHORITY OF THAILAND

(Date of Announcement)

(Mrs. Kannika Dhachalapat)

Chief, International Procurement Department – Transmission Segment



ประกาศการไฟฟ้าฝ่ายผลิตแห่งประเทศไทย
เรื่อง ประกวดราคาซื้อ เลขที่ BBS1-SWG-01

การไฟฟ้าฝ่ายผลิตแห่งประเทศไทย (กฟผ.) มีความประสงค์จะซื้อ 230 kV Compact Switchgear สำหรับระบบส่งไฟฟ้าสำหรับโครงการโรงไฟฟ้าพลังงานแสงอาทิตย์ทุ่นลอยน้ำร่วมกับโรงไฟฟ้าพลังงานน้ำเขื่อนภูมิพล ชุดที่ 1 โดยใช้งบประมาณ กฟผ. ทั้งนี้ โครงการอยู่ระหว่างการขออนุมัติจากคณะรัฐมนตรี การจัดหาครั้งนี้จะไม่ผูกพัน กฟผ. หากโครงการไม่ได้รับอนุมัติ

สถานที่ส่งมอบ : ท่าเรือกรุงเทพฯ / หน้าโรงงานผู้ผลิต

ราคากลาง (รวมภาษีมูลค่าเพิ่มและค่าใช้จ่ายอื่น ๆ) : 55,500,000.- บาท

คุณสมบัติของผู้เสนอราคา

1. ต้องเป็นนิติบุคคลผู้ผลิตหรือเป็นผู้มีอาชีพขายพัสดุตามประกาศ และต้องไม่เป็นผู้ทำงานซึ่งปลัดกระทรวงการคลังได้แจ้งเวียนชื่อไว้ หรือต้องไม่เป็นผู้ที่ กฟผ. ห้ามติดต่อหรือห้ามเข้าเสนอราคา หรือต้องไม่เป็นผู้ที่ได้รับผลของการสั่งให้นิติบุคคลหรือบุคคลอื่นเป็นผู้ทำงานตามคำสั่ง กฟผ.
2. ต้องไม่เป็นผู้มีผลประโยชน์ร่วมกันกับผู้เสนอราคารายอื่น ณ วันประกาศประกวดราคาครั้งนี้เป็นต้นไป หรือต้องไม่เป็นผู้กระทำการอันเป็นการขัดขวางการแข่งขันราคาอย่างเป็นธรรมในการดำเนินการประกวดราคาครั้งนี้
3. ต้องไม่เป็นที่ปรึกษาของ กฟผ. หรือมีส่วนร่วมในบริษัทที่ปรึกษาของ กฟผ. ในงานนี้ หรือต้องไม่มีผู้ปฏิบัติงาน กฟผ. เข้าไปมีส่วนร่วมในกิจการของผู้เสนอราคา ไม่ว่าจะในฐานะผู้ถือหุ้นที่มีสิทธิควบคุมการจัดการ กรรมการ ผู้อำนวยการ ผู้จัดการ พนักงาน ลูกจ้าง ตัวแทน หรือที่ปรึกษา ยกเว้น ในกรณีที่มีผู้ปฏิบัติงานได้รับคำสั่งอย่างเป็นทางการจาก กฟผ. ให้ไปปฏิบัติงานหรือเข้าร่วมในกิจการของผู้เสนอราคา
4. ต้องไม่เป็นผู้ได้รับเอกสิทธิ์หรือความคุ้มกัน ซึ่งอาจปฏิเสธไม่ยอมขึ้นศาลไทย เว้นแต่รัฐบาลของผู้เสนอราคาได้มีคำสั่งให้สละสิทธิ์และความคุ้มกันเช่นนั้น
5. ผู้ประสงค์เข้าประกวดราคาในนามของกิจการร่วมค้าหรือกิจการค้าร่วม (Joint Venture or Consortium) จะต้องดำเนินการทุกขั้นตอนของการประกวดราคาในนามของกิจการร่วมค้าหรือกิจการค้าร่วม ตั้งแต่การเสนอราคาจนถึงสิ้นสุดข้อผูกพันกับ กฟผ.

การขายเอกสารประกวดราคา

ผู้สนใจติดต่อซื้อเอกสารประกวดราคา ในราคาชุดละ _____ ในวันที่ทำการระหว่างเวลา 08:00 น. ถึง 15:00 น. ตั้งแต่วันที่ _____ ถึงวันที่ _____ ทั้งนี้ สามารถดูรายละเอียดการซื้อเอกสารประกวดราคาได้ที่เว็บไซต์ <http://www4.egat.co.th/fprocurement/biddingeng> หรือสอบถามข้อมูลเพิ่มเติมได้ทางโทรศัพท์ หมายเลข 0 2436 0341 หรืออีเมล procurement.tse@egat.co.th

การยื่นซองประกวดราคา

กำหนดยื่นซองประกวดราคา ในวันที่ _____ เวลา 09:00 น. ถึง 10:00 น. และเปิดซองประกวดราคาเวลา 10:00 น. ณ ห้องประกวดราคา ชั้น 1 อาคารฝ่ายจัดซื้อจัดจ้างและบริหารพัสดุ ท.082 การไฟฟ้าฝ่ายผลิตแห่งประเทศไทย เชียงสะพานพระราม 7 จังหวัดนนทบุรี

ประกาศ ณ วันที่ _____

(นางกรรณิกา ธชาลภักดิ์)

หัวหน้ากองจัดซื้อจัดจ้างต่างประเทศสายงานระบบส่ง

ตารางแสดงวงเงินงบประมาณที่ได้รับจัดสรรและราคากลาง(ราคาอ้างอิง)
ในการจัดซื้อจัดจ้างที่มีใช้งานก่อสร้าง

1. ชื่อโครงการ Bid No. BBS1-SWG-01

การจัดซื้อ 230 kV Compact Switchgear

ระบบส่งไฟฟ้าสำหรับโครงการโรงไฟฟ้าพลังงานแสงอาทิตย์ทุ่นลอยน้ำร่วมกับโรงไฟฟ้า
พลังน้ำเขื่อนภูมิพล ชุดที่ 1

/หน่วยงานเจ้าของโครงการ ฝ่ายแผนงานและโครงการระบบส่ง การไฟฟ้าฝ่ายผลิตแห่งประเทศไทย

2. วงเงินงบประมาณที่ได้รับจัดสรร

ระบบส่งไฟฟ้าสำหรับโครงการโรงไฟฟ้าพลังงานแสงอาทิตย์ทุ่นลอยน้ำร่วมกับโรงไฟฟ้า
พลังน้ำเขื่อนภูมิพล ชุดที่ 1 งบประมาณ 1,195.42 ล้านบาท

3. วันที่กำหนดราคากลาง 28 กุมภาพันธ์ 2568 (วันที่ อวส.อนุมัติ)

ราคารวมภาษีมูลค่าเพิ่มและค่าใช้จ่ายอื่นๆ เป็นเงิน 55,500,000.00 บาท ราคา/หน่วย ตามเอกสารแนบ

4. แหล่งที่มาของราคากลาง

หลักเกณฑ์การกำหนดราคากลางการจัดซื้อและจัดจ้างงานก่อสร้างระบบส่งไฟฟ้าของสายงานพัฒนาระบบส่ง

5. รายชื่อเจ้าหน้าที่ผู้กำหนดราคากลาง

5.1 นายภูภัทร พานทอง หสก-ร. กวอ-ร.

5.2 นางสาวอุบลวรรณ วิวัฒน์สุวรรณ วศ.7 หสก-ร. กวอ-ร.

หมายเหตุ ค่าใช้จ่ายอื่นๆ ได้แก่ ค่าใช้จ่ายที่ กฟผ. ต้องจ่ายตามวิธีการพิจารณาเปรียบเทียบราคาที่กำหนดไว้
ในเอกสารประกวดราคา เช่น อากรขาเข้า เป็นต้น

MEDIUM COST TO BID NO.BBS1-SWG-01
SUMMARY OF BID PRICE
SUPPLY OF 230 KV COMPACT SWITCHGEAR
TRANSMISSION SYSTEM FOR HYDRO-FLOATING SOLAR HYBRID PROJECT BHUMIBOL DAM UNIT 1

No.	Description	Currency	Supply of Equipment	Supply of Equipment	Foreign Currency (excluding VAT)	Local Currency (excluding VAT) Baht
			Foreign Supply	Local Supply		
			CFR Thai Port	Ex-works Price (excluding VAT) Baht		
			Amount	Amount		
1	Schedule 1 : 230 kV Compact Switchgear	THB	50,016,072.70		1,556,683.17	
BID PRICE		THB	50,016,072.70		1,556,683.17	
IMPORT DUTY		THB	5,067.11		XXXXX	
CUSTOM CLEARANCE		THB	300,096.44		XXXXX	
VAT		THB	3,501,479.79		108,967.82	
SUMMARY OF BID PRICE		THB	53,822,716.04		1,665,650.99	
TOTAL MEDIUM COST		THB	55,488,367.03			
TOTAL MEDIUM COST (ROUNDED)		THB	55,500,000.00			

 นายสรวิชัย ทิมะมาน
 ผู้อำนวยการฝ่ายวิศวกรรมระบบส่ง
 28 Feb 2025

MEDIUM COST TO BID NO.BBS1-SWG-01
Schedule 1 : 230 kV Compact Switchgear
SUPPLY OF 230 KV COMPACT SWITCHGEAR
TRANSMISSION SYSTEM FOR HYDRO-FLOATING SOLAR HYBRID PROJECT BHUMIBOL DAM UNIT 1

Item No.	Description	Qty.	Unit	Currency	Supply of Equipment				Supply of Equipment		Foreign Currency (excluding VAT)		Local Currency (excluding VAT) Baht			
					Foreign Supply				Local Supply							
					FOB Vessel	Cost of Transportation to Thai Port	CFR Thai Port		Ex-works Price (excluding VAT) Baht							
					Unit Price	Unit Price	Unit Price	Amount	Unit Price	Amount	Unit Price	Amount				
1-1	245 kV 3150 A 50 kA Compact Switchgear as per Ratings and Features RF CW8350(IEC)and Dwg. No.BB2-S-1,total height at terminal of compact switchgear shall be6.00 m(preferable)	4		THB	12,491,350.40		12,491,350.40	49,965,401.60			XXXXX	XXXXX	XXXXX	XXXXX		
1-2	Local Control Cubicle for CW8350(IEC)for Item No.1-1*	4		THB	included	included	included	included			XXXXX	XXXXX	XXXXX	XXXXX		
1-3	Steel Supporting Structure for CW8350(IEC)for Item No.1-1*	4		THB	included	included	included	included			XXXXX	XXXXX	XXXXX	XXXXX		
1-4	Maintenance Closing Device for CB of Compact Switchgear RF CW8350(IEC)	1	set	THB	50,671.10		50,671.10	50,671.10			XXXXX	XXXXX	XXXXX	XXXXX		
1-5	Special tools and appliances for complete installation and maintenance for CW8350(IEC)	1	set	THB	included	included	included	included			XXXXX	XXXXX	XXXXX	XXXXX		
1-6	Service of Installation Supervisor of Compact Switchgear Item No1-1	21.00	man day	THB	XXXXXX	XXXXXX	XXXXXX	XXXXXX	XXXXXX	XXXXXX	74,127.77	1,556,683.17				
	Note : The SF6 gas in a quantity equivalent to 115% of the total equipment actual requirement shall be provided as follows - 100% of SF6 gas quantity shall be shipped in returnable steel bottles which shall be returned back to Contractor. - 15% of SF6 gas quantity shall be shipped in non returnable steel bottles which shall become the property of EGAT.															
Total Price for Schedule 1				THB	50,016,072.70				Baht			1,556,683.17		Baht		

* The design of supporting structures and LCC for Compact Switchgear shall be verified by Compact Switchgear manufacturer.

 นายสรวิชญ์ ทิมมะมาน
 ผู้อำนวยการฝ่ายวิศวกรรมระบบส่ง
 28 Feb 2025

MEDIUM COST TO BID NO.BBS1-SWG-01
Service of Installation Supervisor (Schedule 1)
SUPPLY OF 230 KV COMPACT SWITCHGEAR
TRANSMISSION SYSTEM FOR HYDRO-FLOATING SOLAR HYBRID PROJECT BHUMIBOL DAM UNIT 1

Item No.	Description	Qty.	Unit	Currency	Foreign Currency (excluding VAT)		Local Currency (excluding VAT) Baht	
					Unit Price	Amount	Unit Price	Amount
					1-6	Service of Installation Supervisor of Compact Switchgear Item Nol-1	21.00	man day

Note:

1. The quoted total man-days for installation supervisor shall be the required number of days for complete installation erection, field test and commissioning of all equipment as specified
2. In addition to the quoted total man-days above, EGAT will also pay the following:
 - a. Travelling time from and to Supervisors home office as well as travelling time from and to the installation site including ten(10) working days of operation, if any, which will be at the same rate as the cost quoted per man-day.
 - b. Airfares round trip economy class between the Supervisor's home office and Bangkok by the most expeditious and direct route
3. Local transportation from and to installation site will be provided by EGAT
4. If the working man-days are less than the quoted total man-days, the payment shall be on the basis of actual man-days.
5. For man-days exceeding the quoted total amount no payment shall be made by EGAT. Any such additional man-days approved by EGAT shall be paid on the quoted man-days rate.

 นายสรวิษณ์ ทิมะมาน
 ผู้อำนวยการฝ่ายวิศวกรรมระบบส่ง
 28 Feb 2025

Contract No.

Invitation to Bid No. BBS1-SWG-01

ELECTRICITY GENERATING AUTHORITY OF THAILAND



BIDDING DOCUMENTS

SUPPLY OF 230 kV COMPACT SWITCHGEAR

**TRANSMISSION SYSTEM FOR HYDRO-FLOATING SOLAR
HYBRID PROJECT BHUMIBOL DAM UNIT 1**

EGAT'S FUND

BIDDER : _____

(2025)

INVITATION TO BID NO. BBS1-SWG-01
SUPPLY OF 230 kV COMPACT SWITCHGEAR
TRANSMISSION SYSTEM FOR HYDRO-FLOATING SOLAR
HYBRID PROJECT BHUMIBOL DAM UNIT 1
EGAT'S FUND

CONTENTS

CONFIRMATION FORM

DISCOUNT FORM

ADDITIONAL REGULATION

IMPORTANT INFORMATION

DATA SHEET

SECTION A INVITATION TO BID

SECTION B INSTRUCTIONS TO BIDDERS

SECTION C PROPOSAL

SECTION D CONTRACT

SECTION E GENERAL CONDITIONS

SECTION F SPECIAL CONDITIONS

SECTION G RATINGS AND FEATURES

SECTION H BILL OF MATERIALS (None)

SECTION I SPECIFICATIONS

SECTION J DRAWINGS

CONTENTS

<u>Article No.</u>	<u>Description</u>	<u>Page</u>
	Confirmation Form	-
	Discount Form	-
	Additional Regulation	1-11
	Important Information	i
	Data Sheet	i
 SECTION A : <u>INVITATION TO BID</u> 		
A-1	Invitation	A1
A-2	Eligibility of Bidders: General Requirements	A1
A-3	Eligibility of Bidders: Technical Requirements	A2
A-4	Joint Venture or Consortium	A4
A-5	Preparation and Delivery of Bids	A5
A-6	Availability of Bidding Documents	A6
 SECTION B : <u>INSTRUCTIONS TO BIDDERS</u> 		
	Overview of the Procurement Process	B1
B-1	Preparation of Bids	B2
B-2	Bid Prices	B3
B-3	Bid Security	B5
B-4	Validity of Bids	B6
B-5	Delivery of Bids	B6
B-6	Withdrawal of Bids	B6
B-7	Interpretation of Bidding Documents before Bid Opening	B6
B-8	Information to be Submitted with Bid	B7

<u>Article No.</u>	<u>Description</u>	<u>Page</u>
B-9	Deviations from Specifications	B9
B-10	Rejection of Bids	B9
B-11	Delivery Time	B9
B-12	Evaluation and Comparison of Bids	B10
B-13	Acceptance of Bids	B11
B-14	Appeal	B11
B-15	Award of Contract	B12
B-16	Bidder's Responsibility	B12
B-17	Supplemental Notices	B12
B-18	Cost of Bidding	B13
B-19	Cancellation of Bid	B13
	Specimen of Bid Security	B14
<u>SECTION C : PROPOSAL</u>		
C-1	Price Schedule	C1
C-2	Penalty for Equipment Not Meeting Guaranteed Characteristics	C2
C-3	Guaranteed Delivery Time	C2
C-4	Drawing and Document Submission Schedule	C2
C-5	Estimate of Deliveries	C2
C-6	Bid Security	C3
C-7	Supplemental Notices	C3
	Part 1 : Price Proposal	Project 1-C1
	Part 2 : Proposal Data	Part 2-C1
	Part 3 : Delivery Schedule and Distribution List	Part 3-C1

<u>Article No.</u>	<u>Description</u>	<u>Page</u>
--------------------	--------------------	-------------

SECTION D : CONTRACT

D-1	Contract Documents	D1
D-2	Acceptance of Proposal	D2
D-3	Agreement	D2
D-4	Obligation of Contractor	D2
D-5	Obligation of EGAT	D2
D-6	Mutual Obligations	D3
D-7	Deposit of Performance Security	D3
D-8	Assignment	D3
D-9	Notices	D3
D-10	Integration	D4
D-11	Counterpart	D4

SECTION E : GENERAL CONDITIONS

E-1	Definitions	E1
E-2	Intent of Contract Documents	E2
E-3	Applicable Law and Legal Jurisdiction	E3
E-4	Statutory Requirements	E3
E-5	Patents and Copyrights	E3
E-6	Subcontracts	E4
E-7	Export Charges	E4
E-8	Import Duty and Taxes	E4
E-9	Value Added Tax	E5
E-10	Income and Other Taxes	E6

<u>Article No.</u>	<u>Description</u>	<u>Page</u>
E-11	Fees and Duties	E7
E-12	Performance Security	E8
E-13	Inspection and Tests	E9
E-14	Preparation for Shipment and/or Delivery	E11
E-15	Clearance and Weight Limitations	E13
E-16	Shipment	E13
E-17	Documents Required for Each Shipment	E15
E-18	Force Majeure	E18
E-19	Transportation Insurance	E19
E-20	Transfer of Title	E19
E-21	Changes and Extra or Omitted Work	E19
E-22	Termination and Suspension of Contract	E20
E-23	Default and Termination	E20
E-24	Indemnification by the Contractor	E21
E-25	Limitation of Liability	E22
E-26	Consequential Damages	E22
E-27	Vesting of Contract in Receiver	E22
E-28	Extension of Time	E23
E-29	Failure to Meet Requirements	E23
E-30	Operation or Use of Unsatisfactory Equipment	E26
E-31	Dispute Resolution	E26
E-32	Language and Numbers	E26
	Specimen of Guarantee	E27
	Instructions for Packaging	E28

<u>Article No.</u>	<u>Description</u>	<u>Page</u>
--------------------	--------------------	-------------

SECTION F : SPECIAL CONDITIONS

F-1	Scope of Work	F1
F-2	Responsibility of Contractor	F1
F-3	Cooperation with Other Contractors	F1
F-4	Supervision of Installation	F2
F-5	Acceptance Tests	F3
F-6	Failure to Meet Performance Guarantees	F3
F-7	Acceptance Certificate	F3
F-8	Payment	F4
F-9	Liquidated Damages for Late Delivery of Equipment	F8
F-10	Maintenance Guarantee	F9
F-11	Drawings and Documents to be Furnished by Contractor	F11
F-12	Maintenance Security	F14
	Specimen of Maintenance Guarantee	F16
	Drawings and Documents to be Furnished by the Contractor (For Control and Protection Equipment)	F17
	Drawings and Documents to be Furnished by the Contractor (For All Equipment except Control and Protection Equipment)	F18

SECTION G : RATINGS AND FEATURES

G-1	Ratings and Features	G1
-----	----------------------	----

SECTION H : BILL OF MATERIALS (None)

- - -

<u>Article No.</u>	<u>Description</u>	<u>Page</u>
--------------------	--------------------	-------------

SECTION I : SPECIFICATIONS

I-1	Specifications	I1
-----	----------------	----

SECTION J : DRAWINGS

J-1	Drawings	J1
-----	----------	----

DRAFT

CONFIRMATION FORM

(INDIVIDUAL COMPANY / JOINT VENTURE)

INVITATION TO BID NO. BBS1-SWG-01

SUPPLY OF 230 kV COMPACT SWITCHGEAR

**TRANSMISSION SYSTEM FOR HYDRO-FLOATING SOLAR
HYBRID PROJECT BHUMIBOL DAM UNIT 1**

By signing in the space provided below, we confirm that:-

- According to “Eligibility of Bidders” and in addition to the Documentary List attached to the bidding documents, we are not a Jointly Interested Bidder with the other bidders as from the date of EGAT’s issuance of the subject Invitation and are not a person who undertakes any actions as an “Obstruction of Fair Price Competition”.
- According to Article B-8. Information to be Submitted with Bid, we confirm
 - Registration with the Revenue Department as a value added tax registrant in Thailand as per certificate of value added tax registration (จพ.20) attached.
 - Non-Registration as a value added tax registrant in Thailand, but will register later.
 - Non-Registration as a value added tax registrant in Thailand and will not register.

Confirmed :

.....

By :

Title :

Date :

CONFIRMATION FORM

(CONSORTIUM)

INVITATION TO BID NO. BBS1-SWG-01

SUPPLY OF 230 kV COMPACT SWITCHGEAR

**TRANSMISSION SYSTEM FOR HYDRO-FLOATING SOLAR
HYBRID PROJECT BHUMIBOL DAM UNIT 1**

Member No. ... of the consortium:

By signing in the space provided below, we confirm that:-

- According to “Eligibility of Bidders” and in addition to the Documentary List attached to the bidding documents, we are not a Jointly Interested Bidder with the other bidders as from the date of EGAT’s issuance of the subject Invitation and are not a person who undertakes any actions as an “Obstruction of Fair Price Competition”.
- According to Article B-8. Information to be Submitted with Bid, we confirm
 - Registration with the Revenue Department as a value added tax registrant in Thailand as per certificate of value added tax registration (ภพ.20) attached.
 - Non-Registration as a value added tax registrant in Thailand, but will register later.
 - Non-Registration as a value added tax registrant in Thailand and will not register.

Confirmed :

.....

By :

Title :

Date :

DISCOUNT FORM
(Excluding VAT)

INVITATION TO BID NO. BBS1-SWG-01

SUPPLY OF 230 kV COMPACT SWITCHGEAR

**TRANSMISSION SYSTEM FOR HYDRO-FLOATING SOLAR
HYBRID PROJECT BHUMIBOL DAM UNIT 1**

Bidder : _____

By signing in the space provided below, we confirm that:-

- we offer no discount.
- we offer discount(s) as follows:

Details of discount	Currency	Amount

Remarks :

- ***The Bidder shall apply discount(s) on any item(s), schedule(s), or the total price, excluding Value Added Tax (VAT).***
- The above discount(s) shall not be subject to any conditions. Discount with conditions shall not be considered.
- This Discount Form, together with Bidder's Summary of Bid Price, will be publicly presented on a screen to all Bidders in the bid opening room at the time of bid opening.

Confirmed by authorized person(s):

.....

By :

Title :

Date :

Additional Regulation

This Regulation shall apply to the Enquiry, Bid for Supply, Lease, Hire of Work, or Hire of Consultant by Way of Selection.

1. Attachments
 - 1.1 Definitions
 - 1.1.1 Jointly Interested Bidder
 - 1.1.2 Obstruction of Fair Price Competition
 - 1.2 Documentary List
2. Bidder's Qualifications
 - 2.1 The Bidder shall professionally be in the business of providing materials or services or leasing or consultancy services, as the case may be, and shall not be named in the list of work abandoners published by the Permanent Secretary, Ministry of Finance, and/or in the debarment list and/or the list of work abandoners declared by EGAT according to Article 5 of this Regulation.
 - 2.2 The Bidder shall not be a Jointly Interested Bidder with other bidders as from the date of EGAT's issuance of the Invitation for Bid/Enquiry or the Invitation Letter/ Terms of Reference for the consultancy services, as the case may be, or shall not be a person who undertakes any action as an "Obstruction of Fair Price Competition" described in Article 1.1 – Definitions.
 - 2.3 The Bidder shall not have EGAT's personnel involve in his business as shareholder having voting right that can control his business, director, manager, officer, employee, agent or consultant except for the ones who are officially ordered by EGAT to act or participate therein.
3. Information to be Submitted with Bid

The Bidder shall submit with his bid the documents according to Article 1.2 - Documentary List, including but not limited to, the following documents :-

 - 3.1 Where the Bidder is a juristic person :
 - (a) ordinary partnership or limited partnership
a certified copy of affidavit of incorporation, name list of managing partners, list of persons entrusted with controlling power (if any), as well as a certified copy of registration for value added tax (if any).
 - (b) limited company or public limited company
a certified copy of affidavit of incorporation, memorandum of association, name list of managing directors, list of persons entrusted with controlling power (if any) and name list of major shareholders, as well as a certified copy of registration for value added tax (if any).

Such certified copy of affidavit of incorporation with the validity of not more than six (6) months from the date of certification to the opening date of Bid/Enquiry or the date of Invitation Letter/Terms of Reference in case of consultancy services, as the case may be, shall certify at least the following information :

- (i) Type of a juristic person : an ordinary partnership, a limited partnership, a limited company, a public limited company,
- (ii) Name according to (i),
- (iii) Number and names of managing partners or managing directors,
- (iv) Number and names of managing partners or managing directors authorized to act on behalf of the company,
- (v) Amount of shareholders' equity or registered capital,
- (vi) Authority of managing partner in case of partnership,
- (vii) Location of head office,
- (viii) Registration purposes,

- (ix) Scope of work indicated in business permit license of a foreign juristic person who registers in Thailand,
- (x) Other documents e.g. changes or additions to the above documents, branches (if any).

3.2 Where the Bidder is a natural person or a group of persons other than a juristic person :

a certified copy of :

- identity card **or passport (if non-Thai national)**
- partnership agreement or contract (if any)
- partners' identity cards **or passport (if non-Thai national)**
- registration required by Ministry of Commerce of Thailand
- registration for value added tax (if any)

3.3 Where the Bidder is a joint venture / consortium :

a certified copy of :

- association agreement
- identity card or passport (if non Thai national)
(The participant in the joint venture or consortium is not a juristic person.)
- all documents specified in *Item 3.1* of Additional Regulation
(The participant in the joint venture or consortium is a juristic person.)

3.4 Other documentary evidence as required per *Item 3, 6 or 8* of Documentary List (if any).

4. Preliminary Examination

4.1 EGAT shall examine the qualification of all bidders to determine whether any bidder is a Jointly Interested Bidder as from the date of EGAT's issuance of the Invitation for Bid/Enquiry or the Invitation Letter/Terms of Reference for the consultancy services, as the case may be, and/or undertakes any action as an "Obstruction of Fair Price Competition" before or during the bid opening. If there is evidence showing that any bidder is a Jointly Interested Bidder or undertakes any action as an "Obstruction of Fair Price Competition", EGAT shall delete his name from the list of bidders and inform such bidder by written notice hereof.

4.2 The Bidder whose name is deleted according to Article 4.1, may, within fifteen (15) calendar days from the date of receipt of EGAT's written notice, appeal to EGAT, explaining reasons together with relevant documents for EGAT's reconsideration.

In case EGAT agrees with the objection of the appellant but considers that the cancellation of enquiry/bidding will be beneficial to EGAT, EGAT may, at its sole discretion, cancel such bid. In the event that the Bidder who undertakes any action as an "Obstruction of Fair Price Competition" does not appeal or, after his appeal, EGAT does not agree with his objection, such Bidder shall be regarded as a work abandoner.

EGAT's decision shall be notified to the appellant in writing and such decision shall be final and conclusive.

5. Reservation of the Right for Proposal and Others

In case any juristic person is regarded as a work abandoner by EGAT and such abandonment is caused by the manager, the managing partner, the managing director, the executive or the person authorized to manage the business of that juristic person, EGAT shall also include his name as a work abandoner.

In case any juristic person is regarded as a work abandoner by EGAT, such decision shall also be applied to other juristic persons of the same business where its manager, managing partner, managing director, executive, or person authorized to manage the business is the same person who is the manager, managing partner, managing director, executive, or person authorized to manage the business of the juristic person who is regarded as a work abandoner by EGAT as aforesaid.

In case any natural person is regarded as a work abandoner by EGAT, such decision shall also be applied to other juristic persons who submit the proposal and have such natural person as the manager, managing partner, managing director, executive or person authorized to manage the business of such juristic persons

1.1 Definitions

These definitions shall apply to the Enquiry, Bid for Supply, Lease, Hire or Work, or Hire of Consultant by Way of Selection.

1.1.1 **“Jointly Interested Bidder”** means a natural person or juristic person who submits bid to EGAT for the supply of goods, lease, hire of work, or hire of consultant by way of selection, as the case may be, and who has an interest, either directly or indirectly, in the business of another natural person or juristic person whose bid is also submitted to EGAT in this bidding.

The interest, either direct or indirect, in another natural person or juristic person as aforesaid includes the relationship in the following manners :

- (1) Management relationship, whereby the manager, the managing partner, the managing director, the executive or the person authorized to manage the business of a natural person or a juristic person has the power, or is able to exercise the power, in managing the business of the other one or more natural persons or juristic persons whose bids are also submitted to EGAT in this bidding.
- (2) Capital relationship, whereby a partner in an ordinary partnership or a partner with unlimited liability in a limited partnership or a major shareholder in a limited company or a public limited company is a partner in the other one or more ordinary partnerships or limited partnerships, or is a major shareholder in the other one or more limited companies or public limited companies whose bids are also submitted to EGAT in this bidding.
- (3) Cross relationship between (1) and (2), whereby the manager, managing partner, managing director, executive or person authorized to manage the business of a natural person or juristic person is a partner in the other one or more ordinary partnerships or limited partnerships, or is a major shareholder in the other one or more limited companies or public limited companies whose bids are also submitted to EGAT in this bidding, or *vice versa*.

“Major shareholder” means a shareholder who holds more than twenty five (25) percent of stake in such an enterprise or at another percentage determined by the Governor as he deems expedient for some types or sizes of enterprises.

Holding of position, being a partner or shareholding as aforesaid by the spouse or minor of the person in (1), (2) or (3) shall be deemed the holding of position, being a partner or shareholding by such person.

If any bidder uses the name of another person as the manager, managing partner, managing director, executive, partner or shareholder, but in which case he himself in fact exercises the power in management or he himself is the real partner or shareholder of the partnership or limited company or public limited company, as the case may be, and the related partnership or limited company or public limited company whose bid is also submitted to EGAT in this bidding, that bidder shall be deemed to have a relationship under (1), (2) or (3), as the case may be.

1.1.2 ***“Obstruction of Fair Price Competition”*** means any act committed by a bidder or bidders causing hindrance or obstruction or impeding the opportunity for fair price competition in the tendering of bid to EGAT, whether done by collusion, or by granting, requesting, or agreeing to grant, demand, accept or agreeing to accept money or property or other benefit or by committing an act of violence or by threatening to commit an act of violence or presenting a false document or doing any act in bad faith, with the objective of acquiring benefit among the other bidders or in order to give benefit to any specific bidder so that such person will be entitled to enter into a contract with EGAT or in order to avoid fair price competition, or in order to take advantage to EGAT which not being usual business practices.

DRAFT

1.2 Documentary List

This documentary list shall apply to the Enquiry, Bid for Supply, Lease, Hire of Work, or Hire of Consultant by Way of Selection.

	No. of page(s)	For EGAT only	
<u>Thai National Bidder</u>			
[] 1. Where the Bidder is a natural person or a group of persons other than a juristic person			
() (a) Natural Person		Yes	No
- Certified copy of identity card		<input type="checkbox"/>	<input type="checkbox"/>
() (b) Group of persons			
- Certified copy of partnership agreement or contract (if any)		<input type="checkbox"/>	<input type="checkbox"/>
- Certified copy of identity card(s) of partners or related documents according to Item 2 (a) and (b) of each participant of the group		<input type="checkbox"/>	<input type="checkbox"/>
[] 2. Where the Bidder is a juristic person			
() (a) Ordinary partnership or limited partnership			
- Certified copy of affidavit of incorporation		<input type="checkbox"/>	<input type="checkbox"/>
- Name list of managing partners and list of persons entrusted with controlling power (if any)		<input type="checkbox"/>	<input type="checkbox"/>
(Please fill in the form on page 10.)			
() (b) Limited company or public limited company			
- Certified copy of affidavit of incorporation		<input type="checkbox"/>	<input type="checkbox"/>
- Memorandum of Association		<input type="checkbox"/>	<input type="checkbox"/>
- Name list of managing directors and list of persons entrusted with controlling power (if any)		<input type="checkbox"/>	<input type="checkbox"/>
(Please fill in the form on page 10.)			
- Name list of major shareholders		<input type="checkbox"/>	<input type="checkbox"/>
(Please fill in the form on page 11.)			
[] 3. Other documents (if any)			
() Certified copy of any other registration required by Ministry of Commerce of Thailand		<input type="checkbox"/>	<input type="checkbox"/>
() Certified copy of registration for value added tax		<input type="checkbox"/>	<input type="checkbox"/>
()		<input type="checkbox"/>	<input type="checkbox"/>
()		<input type="checkbox"/>	<input type="checkbox"/>

No. of page(s)

For EGAT only

Non-Thai National Bidder

		For EGAT only	
		Yes	No
[]	4. Where the Bidder is a natural person or a group of persons other than a juristic person		
()	(a) Natural Person		
	- Certified copy of passport	<input type="checkbox"/>	<input type="checkbox"/>
()	(b) Group of persons		
	- Certified copy of partnership agreement or contract (if any)	<input type="checkbox"/>	<input type="checkbox"/>
	- Certified copy of passport of partners or related documents according to Item 5 of each participant of the group	<input type="checkbox"/>	<input type="checkbox"/>
[]	5. Where the Bidder is a juristic person		
	- Certified copy of affidavit of incorporation	<input type="checkbox"/>	<input type="checkbox"/>
	- Name list of managing partners, directors, etc., as the case may be, and list of persons entrusted with controlling power (if any)	<input type="checkbox"/>	<input type="checkbox"/>
	- Memorandum of Association (if any) (Please fill in the form on page 10.)	<input type="checkbox"/>	<input type="checkbox"/>
	- Name list of major shareholders (if any) (Please fill in the form on page 11.)	<input type="checkbox"/>	<input type="checkbox"/>
[]	6. Other documents (if any)		
()	<input type="checkbox"/>	<input type="checkbox"/>
()	<input type="checkbox"/>	<input type="checkbox"/>
()	<input type="checkbox"/>	<input type="checkbox"/>
()		
()		

Thai and Non-Thai National Bidder

		No. of page(s)	For EGAT only	
			Yes	No
[]	7. Where the Bidder is a joint venture / consortium			
	- Certified copy of association agreement	<input type="checkbox"/>	<input type="checkbox"/>
()	(a) If participant of a joint venture / consortium is not a juristic person			
	(i) Thai national			
	- Certified copy of identity card	<input type="checkbox"/>	<input type="checkbox"/>
	(ii) Non-Thai national			
	- Certified copy of passport	<input type="checkbox"/>	<input type="checkbox"/>
()	(b) If participant of a joint venture / consortium is a Thai-national juristic person			
	() (i) Ordinary partnership or limited partnership			
	- Certified copy of affidavit of incorporation	<input type="checkbox"/>	<input type="checkbox"/>
	- Name list of managing partners, and list of persons entrusted with controlling power (if any) (Please fill in the form on page 10.)	<input type="checkbox"/>	<input type="checkbox"/>
	() (ii) Limited company or public limited company			
	- Certified copy of affidavit of incorporation	<input type="checkbox"/>	<input type="checkbox"/>
	- Memorandum of Association	<input type="checkbox"/>	<input type="checkbox"/>
	- Name list of managing directors, and list of persons entrusted with controlling power (if any) (Please fill in the form on page 10.)	<input type="checkbox"/>	<input type="checkbox"/>
	- Name list of major shareholders (Please fill in the form on page 11.)	<input type="checkbox"/>	<input type="checkbox"/>

		No. of page(s)	For EGAT only	
			Yes	No
()	(c) If member of a joint venture / consortium is a Non-Thai national juristic person			
-	Certified copy of affidavit of incorporation	<input type="checkbox"/>	<input type="checkbox"/>
-	Name list of managing partners, directors, etc., as the case may be, and list of persons entrusted with controlling power (if any) (Please fill in the form on page 10.)	<input type="checkbox"/>	<input type="checkbox"/>
-	Memorandum of Association (if any)	<input type="checkbox"/>	<input type="checkbox"/>
-	Name list of major shareholders (if any) (Please fill in the form on page 11.)	<input type="checkbox"/>	<input type="checkbox"/>
[]	8. Other documents (if any)			
()	Certified copy of any other registration required by Ministry of Commerce of Thailand	<input type="checkbox"/>	<input type="checkbox"/>
()	Certified copy of registration for value added tax in Thailand	<input type="checkbox"/>	<input type="checkbox"/>
()	<input type="checkbox"/>	<input type="checkbox"/>
()	<input type="checkbox"/>	<input type="checkbox"/>
()	<input type="checkbox"/>	<input type="checkbox"/>

We hereby confirm that all documents detailed above are true and correct.

Signed

(Name of Bidder)

stamp company seal (if any)

List of Names of Manager / Managing Partner / Managing Director / Executive /
 Person Who Is Authorized to Manage the Business
 (Relationship in Management)

Bidder shall fill in and submit this form with his bid

Enquiry / Bid No : Enquiry / Bid Opening Date :

Name of Company / Partnership / Juristic Person :

No.	Name – Surname	Position	Name – Surname of Spouse	Name – Surname of Minor

We hereby confirm that all documents submitted are true and correct.

Signed _____
 (Name of Bidder)

Stamp company seal (if any)

Remarks

1. The unused wordings shall be struck out.
2. Duplicate this page as necessary.

List of Partner in Ordinary Partnership / Partner with Unlimited Liability in Limited Partnership /
Major Shareholder in Limited Company or Public Limited Company
(Relationship in Capital)

Bidder shall fill in and submit this form with his bid

Enquiry / Bid No. : Enquiry / Bid Opening Date :

Name of Company / Partnership / Juristic Person :

Registered Capital : (currency)..... Number of Share : Price per Share : (currency).....

No.	Name - Surname	Position	Number of Share (%) or Amount of Shareholder's Equity	Name – Surname of Spouse	Number of Share (%) or Amount of Shareholder's Equity	Name – Surname of Minor	Number of Share (%) or Amount of Shareholder's Equity

We hereby confirm that all documents submitted are true and correct.

Signed _____

(Name of Bidder)

Stamp company seal (if any)

Remarks

1. The unused wordings shall be struck out.
2. "Major Shareholder" means a shareholder who holds more than twenty-five (25) per cent of stake in an enterprise. The shareholding of spouse or minor of a person shall be regarded as being the shareholding of such person. In case of no major shareholder, please specify "No major shareholder" in the tabulation above.
3. Duplicate this page as necessary.
4. The Bidder shall submit List of Names of Manager/ Managing Partner/ Managing Director/ Executive/ Person Who Is Authorized to Manage the Business (Relationship in Management)/ and List of Partner in Ordinary Partnership/ Partner with Unlimited Liability in Limited Partnership/ Major Shareholder in Limited Company or Public Limited Company (Relationship in Capital) of the Bidder as per page 10-11 of this Additional Regulation.

Important Information

for

Invitation to Bid No. BBS1-SWG-01

The purpose of this section is to inform the Bidders to **carefully study** the details of the revised terms and conditions in the bidding documents. The following provisions have been **recently revised** as stated hereunder:

Article A-5. Preparation and Delivery of Bids and Article B-1. Preparation of Bids

Details on how to prepare the proposal have been revised. Bids shall be prepared in accordance with the Instructions to Bidders contained in the Bidding Documents in one (1) original hard copy and one (1) electronic copy contained in USB flash drive.

Article A-5. Preparation and Delivery of Bids

Details of bid opening time and place shall be specified in the Tentative Schedule.

Article A-6. Availability of Bidding Documents

Availability of Bidding Documents has been changed from CD-ROM to electronic files for download via link provided by EGAT.

Channel of Documents Submission

For channel of document submission in the hereunder Articles, facsimile and telex has been replaced with letters submitted electronically or electronic mails (E-mails).

- Article B-1. Preparation of Bids
- Article B-4. Validity of Bids
- Article D-9. Notices
- Article E-17. Documents Required for Each Shipment
- Article F-8. Payment

Article B-2. Bid Prices

For Source of Supply and Service b., Prices for Equipment manufactured outside Thailand (imported Equipment) shall be firm, stated both on FOB Port of Shipment/Vessel and CFR Thai Port basis, and quoted in Thai baht, US dollar, euro, Japanese yen, renminbi (Chinese yuan), or in the Bidder's or Manufacturer's home currency only if his currency trading is prevailed at the time of bidding in any international market other than in Bidder's or Manufacturer's home country.

The following paragraph has also been added :-

“Prices for the following Equipment manufactured outside Thailand which was imported before the bid opening date shall be firm ex-works and quoted in Thai baht, provided that the Bidder shall submit any document(s) evidencing the importation date of such Equipment:

- Power Fuse
- Stationary Battery and Battery Charger
- Insulator for substation
- Cable Termination
- Compression Connector and Miscellaneous Hardware
- Bus Fittings
- Grounding Material
- Substation Miscellaneous”

Article E-16. Shipment

The Maritime Promotion Bureau has been updated to the Maritime Promotion Division and its contact information has also been updated.

Article F-8. Payment

After each payment is made, the Contractor or beneficiary shall issue and submit the receipt to EGAT as detailed in the paragraph added at the end of this article.

DRAFT

DATA SHEET

DATA SHEET

for

Invitation to Bid No. BBS1-SWG-01

This section consists of provisions that are specific to each procurement and supplement the information or requirements included in bidding documents.

Article A-1. Invitation

Insert the following as the second and third paragraphs of this article respectively:

“ The Letter of Award of Contract to be issued to the successful Bidder will be made after EGAT obtains the Project approval from the Government of Thailand, and the approval for Project implementation from the Government’s authority and/or other related entities as required (if any) by Thai laws.

Unless EGAT gets approval as such, the Project and the work under this invitation has to be cancelled. In the event such cancellation is required, all costs incurred by the Bidder in purchasing documents and preparing his bid shall be at his own account and will not be reimbursed by EGAT.”

Article B-3. Bid Security

The amount of bid security shall be USD 90,380.- or THB 3,050,000.-.

Article B-4. Validity of Bids

The validity of the bid shall be for one hundred and fifty (150) Days from the date specified for opening of bid.

Article B-8. Information to be Submitted with Bid

Item m. is not applicable

Article B-12. Evaluation and Comparison of Bids:

The evaluation of bid prices shall be on schedule basis.

Article E-29. Failure to Meet Requirements and F-10. Maintenance Guarantee

Maintenance Guarantee Period

- For all Equipment except 230 kV Compact Switchgear, Shunt Reactor, 200 MVA 230 kV and above Power Transformer and 500 kV System Voltage Equipment

The Contractor shall guarantee the proper functioning of Equipment for a period of one (1) Year except the following Equipment the guarantee period of which shall be as follows :

<u>Equipment</u>	<u>Period of Guarantee (Year)</u>
- Fault Recording System	2
- Control and Protection System	2

- For 230 kV Compact Switchgear
The Contractor shall guarantee the proper functioning of Equipment for a period of three (3) Years.
- For Shunt Reactor, 200 MVA 230 kV and above Power Transformer and 500 kV System Voltage Equipment
The Contractor shall guarantee the proper functioning of Equipment for a period of five (5) Years.

Defective Equipment to be replaced with the whole new set

For GIS, Power Transformer, Power Circuit Breaker, Shunt Reactor, in case EGAT, at its sole discretion, requires the Contractor to replace any defected Equipment, the Contractor shall replace the Equipment with the whole new set as specified in Failure to Meet Requirements in section E and Maintenance Guarantee in section F.

Article F-9. Liquidated Damages for Late Delivery of Equipment

The Liquidated Damages shall be at the rate of one-tenth of one (0.10) per cent of the price of each complete Schedule of Equipment not timely delivered for each Day of delay. This sum is payable regardless of the actual loss and/or damages incurred.

DRAFT

SECTION A
INVITATION TO BID

INVITATION TO BID NO. BBS1-SWG-01
SUPPLY OF 230 kV COMPACT SWITCHGEAR
TRANSMISSION SYSTEM FOR HYDRO-FLOATING SOLAR
HYBRID PROJECT BHUMIBOL DAM UNIT 1

A-1. Invitation

The Electricity Generating Authority of Thailand (EGAT) hereby invites sealed bids for furnishing and delivering of 230 kV Compact Switchgear under Transmission System for Hydro-Floating Solar Hybrid Project Bhumibol Dam Unit 1 hereinafter called Equipment in accordance with the terms, conditions and Specifications described in these Bidding Documents.

A-2. Eligibility of Bidders: General Requirements

All Bidders shall meet the following requirements; failure to so comply shall constitute sufficient ground for rejection.

- a. The Bidder shall be a partnership, firm or company, either alone or in joint venture or in consortium.
- b. The Bidder must have purchased the bidding documents from EGAT. For a joint venture or a consortium, only one (1) member of the joint venture or consortium is required to purchase the bidding documents.

In case the Bidder's name is not exactly the same as the purchaser's name, the purchaser shall notify EGAT of the name of the Bidder in writing prior to the bid opening time.

- c. The Bidder shall be well-established and maintain a permanent place of business. For a joint venture or consortium, all members of the joint venture or consortium are required to meet this qualification.
- d. The Bidder shall not be named in the List of Work Abandoners published by the Permanent Secretary, Ministry of Finance, and/or in the Debarment List and/or in the List of Work Abandoners declared by EGAT.

- e. For the Bidder who changes name before submitting the bid, his experience records in previous name shall be considered as the experience records of the Bidder.
- f. The Bidder shall not be a Jointly Interested Bidder with other Bidders as from the date of EGAT's issuance of this invitation to bid, or shall not be a person who undertakes any action as an "Obstruction of Fair Price Competition" as defined in Additional Regulation for this invitation.
- g. The Bidder shall not either be EGAT's consultant or involve in EGAT's consultancy company under this invitation, or have EGAT's personnel involved in his business as shareholder having voting right that can control his business, director, manager, officer, employee, agent or consultant except the ones who are officially ordered by EGAT to act or participate therein.
- h. The Bidder shall not be the person who is privileged or protected not to be taken any legal proceeding under Thai court; provided that such Bidder's government declares that such special privilege is waived.
- i. In case of a joint venture or consortium, the Bidder shall carry out all the provision of the Equipment and all Work under such formation from the time of bidding until the fulfillment of the Contract and the parties to the joint venture or the consortium shall accept joint and several liability for performing all obligations under the bid and the Contract.
- j. The Bidder shall not propose to supply the Equipment from the country under the state of war whether declared or not.
- k. The Bidder shall have adequate fund to meet financial obligations incidental to this Contract.
- l. The Bidder shall submit documentary evidence established in accordance with Article B-8. Information to be Submitted with Bid to demonstrate the Bidder's sufficient eligibility to bid and qualification to perform the Contract.

A-3. Eligibility of Bidders: Technical Requirements

- 1. All Bidders shall meet the following requirements; failure to so comply shall constitute sufficient ground for rejection.*
 - a. The Bidder shall manufacture or supply the Equipment or Work as required under this invitation to bid.

- b. If the Bidder is a new company formed by acquisition of or merger with other companies or business units before submitting the Bid, the experience records of any of such previous companies or business units that meet the requirements set forth herein are acceptable as the experience records of the Bidder.
- c. The Bidder shall have no just or proper claims pending against the Bidder with respect to breach in the performance of contract on other similar works awarded by EGAT. If the Bidder is a new company formed by acquisition of or merger with other companies or business units, the pending claim of any of such previous companies or business units shall be considered pending claim of the Bidder.
- d. The Bidder shall have sufficient capacity to carry out the Work.
- e. The Bidder shall propose the Equipment manufactured by the qualified manufacturers who shall fulfill the following requirements:
 1. Being well-established and maintaining a permanent place of business.
 2. The manufacturer shall have the experience records that meet the requirements set forth herein.

Reference records of either parent or affiliated companies shall not be considered as the records of such manufacturer.

3. If the Manufacturer is a new company formed by acquisition of or merger with other companies or business units, and any of such previous companies or business units has the experience records that meet the requirements set forth herein, such experience records are acceptable as the experience records of the new company, provided that each item of the equipment to be supplied under this bid shall be manufactured from the same source of supply as indicated in each of such relevant supply records as described in Item e.5 below. Otherwise, it shall not be acceptable and shall be sufficient grounds for rejection.

For the avoidance of doubt, it is not allowed to combine the experience records of the previous companies or business units in order to meet the experience requirements.

4. Regularly manufacturing of Equipment of the type and ratings proposed.
5. Having one of the following qualifications for the required Equipment as follows:
 - 5.1 Proposing the Equipment of the type and ratings which have ever been accepted by EGAT.

OR

- 5.2 Having a supply record of Equipment of the type proposed at nominal system voltage of 220 kV or above, 3000 A or above, 50 kA or above, with successful operation/use of at least three (3) consecutive years in an overseas country (not his own country) and at least three (3) three phase sets.

However, the Equipment of the type and ratings proposed shall have a supply record of successful operation/use of at least three (3) consecutive years in overseas country (not his own country) and at least one (1) three phase set.

In case that supply record of Equipment of the type and ratings proposed fulfilled the requirement, the manufacturer may propose a newly developed or modified type of such Equipment with successful operation/use of at least one (1) year in overseas country (not his own country) and at least three (3) three phase sets. The detailed information of the development or modification shall be submitted with his proposal. EGAT, however, reserves the right and will make its own judgment whether or not to consider or accept the proposed developed or modified type.

6. Having a past design test record of the Equipment as proposed or having a design test record of Equipment of the same type and ratings as proposed from parent manufacturer or parent company, parent manufacturer or parent company shall certify and be responsible for design, production and qualification control. If specified in EGAT's specification, such past design test record shall conform to the test specified in EGAT's specification.
7. Proposing the manufacturer who has no just or proper claims pending against Equipment on other similar works.

In case the manufacturer is a new company formed by acquisition or merger with other companies or business units, the pending claim of any of such previous companies or business units shall be considered pending claim of the manufacturer.

A-4. Joint Venture or Consortium

In the event that the successful Bidder is a joint venture or a consortium formed of two or more companies, EGAT requires that the parties to the joint venture or the consortium accept joint and several liability for all obligations under the Contract.

A-5. Preparation and Delivery of Bids

Bids shall be prepared in accordance with the Instructions to Bidders contained in the Bidding Documents in one (1) original *hard copy and one (1) electronic copy contained in USB flash drive*, in English, on the bid forms included for this purpose and shall be accompanied with a bid security as required under Article B-3. Bid Security in a separate sealed envelope.

For preparation of original hard copy, each page of the original hard copy shall be marked with the volume number and the page number in the lower right-hand corner, for example, Volume 1 of 10 and Page 1 of 100.

For preparation of electronic copy, each volume of the signed original hard copy shall be scanned into one (1) PDF file and each PDF file shall be named according to the volume number.

The USB flash drive shall contain electronic files of the proposal in the following formats :-

- PDF files of all pages of each volume of the proposal, and*
- Excel files of filled-in Proposal Data, and*
- Excel files of filled-in Price Schedule*

In the event of any discrepancy between the original hard copy and the electronic file(s), the original hard copy shall govern.

The envelope of the bids will be marked in capital letters in the lower left-hand corner as follows :

INVITATION TO BID NO. BBS1-SWG-01

SUPPLY OF 230 kV COMPACT SWITCHGEAR

**TRANSMISSION SYSTEM FOR HYDRO-FLOATING SOLAR
HYBRID PROJECT BHUMIBOL DAM UNIT 1**

and shall be addressed and delivered to :

International Procurement Department - Transmission Segment
Procurement and Inventory Management Division
Electricity Generating Authority of Thailand
Bangkruai, Nonthaburi 11130
Thailand

on or before 10:00 a.m., Bangkok Standard Time,*see Tentative Schedule*.....

If the envelope(s) is not sealed, marked and addressed as required above, EGAT will assume no responsibility for the bid misplacement or premature opening.

Bids will be opened publicly at the *place and* time specified *in Tentative Schedule*.

Bids received after the time stipulated herein shall be rejected and returned unopened.

A-6. Availability of Bidding Documents

The Bidding Documents are available for examination *and online purchase at <http://www4.egat.co.th/fprocurement/biddingeng/>* and can be obtained *by downloading via link provided by EGAT* upon payment to EGAT, non-refundable, in the amount of USD 70.- or Baht 2,000.-. These prices include the value added tax.

DRAFT

SECTION B
INSTRUCTIONS TO BIDDERS

INSTRUCTIONS TO BIDDERS

Overview of the Procurement Process

Bid prices and the Contract Price shall include value added tax (VAT) imposed under the law of Thailand. The medium cost announced by EGAT is inclusive of VAT and other relevant expenses.

The amounts of performance security, maintenance security, and liquidated damages shall also be based on the Contract Price which is inclusive of VAT (if any).

For evaluation and comparison of Bids, the bid price shall be evaluated according to the conditions specified in the bidding document.

The procurement process is summarized in the following diagram.

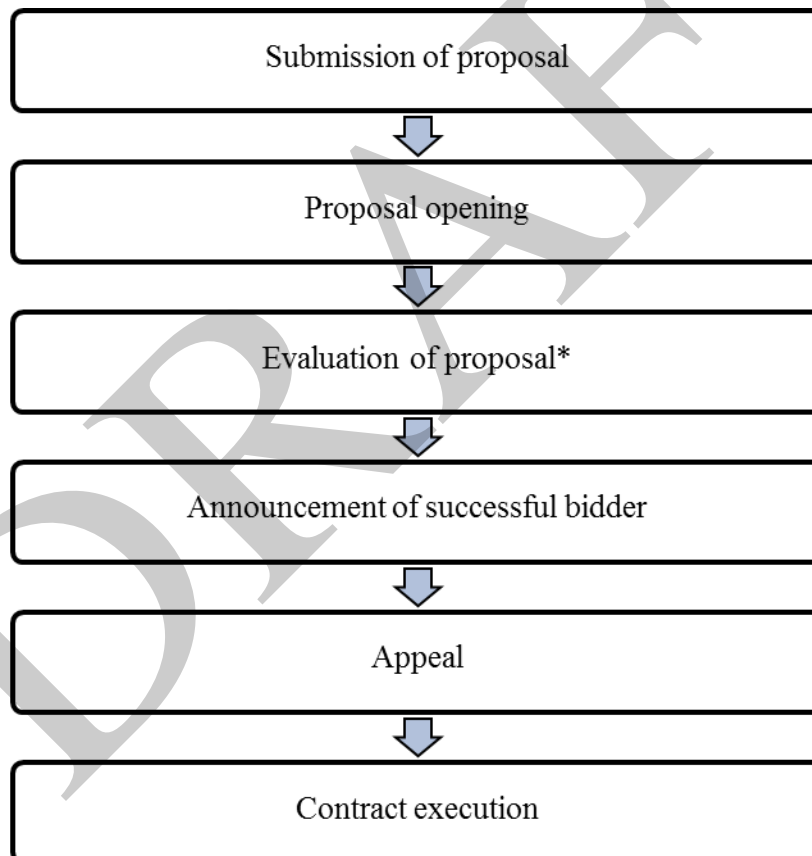

*Remarks

1. The Bidder shall be deemed to have carefully examined all of the terms, conditions and Specifications of the Bidding Documents.
2. EGAT will take into consideration the conformity of the bid to the requirements of the Bidding Documents as well as the suitability for the purpose intended.
3. EGAT will not be bound to accept the bid with the lowest indicated cost. EGAT reserves the right to accept the bid which in its judgement is the lowest evaluated bid.

B-1. Preparation of Bids

- a. Bids shall be prepared in English, in one (1) original *hard copy clearly marked “Original” and one (1) electronic copy contained in USB flash drive*, submitted at the place and time specified for receipt of bids.

In the event of any discrepancy between *the original hard copy and the electronic copy, the original hard copy* shall govern.

For Proposal Data, Bidder shall fill in information of Proposal Data in Excel files contained in the Bidding Documents, and submit one (1) original hard copy with the PDF and Excel files in USB flash drive to EGAT at the same time of bid submission.

For price quotation, Bidder *shall fill in* bid prices in an Excel files of Price Schedules contained in the Bidding Documents in accordance with Price Quotation Instructions in Section C, Part 1: Price Proposal, and submit one (1) original *hard copy with the PDF and Excel files in USB flash drive* to EGAT at the same time of bid submission.

VAT at the prevailing rate shall be filled automatically in the Summary of Bid Price of the price schedule in the Excel file subject to Article B-2. Bid Prices.

However, in case Bidder is a consortium formed of two or more companies, Bidder must also submit one (1) original hard copy *with the PDF and Excel files* of price schedules of the Work performed by each member of the consortium in addition to hard copies *with the PDF and Excel files* of the total bid price as specified above.

If any discrepancy between the bid prices of the Work performed by each member of the consortium and the bid prices of the Bidder occurs, the bid prices of the Bidder shall govern and the bid prices of the Work performed by each member of the consortium shall be adjusted accordingly.

In the event of discrepancy between the original hard copy *and the PDF or Excel files* submitted, the original hard copy shall govern.

- b. Bidder shall not submit more than two (2) proposals and the proposal(s) to be submitted shall conform to the specifications. In case of any deviation from the specifications, Bidder shall follow the provisions under Article B-9. Deviations from Specifications.
- c. The "Original" shall be prepared on the bid forms included and made a part of the Bidding Documents, which shall be submitted with all applicable blanks in the bid forms properly filled in, and shall be manually signed in ink by a person or

persons duly authorized. The letter of authorization shall be indicated by written power-of-attorney accompanying the bid.

All pages of the bid, except for unamended printed literature, shall be initialled by the person or persons signing the bid.

- d. The bid shall contain no interlineations, erasures or overwriting except as necessary to correct errors made by the Bidder, in which case such corrections shall be initialled by the person or persons signing the bid.
- e. Modification by letter or *by letter submitted electronically or by electronic mail (E-mail)* to bids already submitted will be considered if received prior to the time fixed for the receipt of bids. Confirmation by letter of any modification *evidenced* by post mark or by *letter submitted electronically or by electronic mail (E-mail)* should be sent to EGAT not later than the deadline for submission of Bids.
- f. No Bidder will be permitted to alter his bid after the bids have been opened, but clarifications not changing the substance of the bid therein may be accepted.
- g. Bidder may quote for any schedule or all schedules as called for, but shall quote for all items of the schedule(s) proposed. Consideration will be made as stipulated in Article B-12. Evaluation and Comparison of Bids.
- h. Any price discount to be offered shall be clearly stated in the Discount Form accompanied with the Bid to be submitted on the bid opening date specified herein.

B-2. Bid Prices

Currency

Bid prices as shown in Article C-1. Price Schedule shall be firm, not subject to adjustment and payable in the currencies as follows :

- a. The bid price shall be quoted in Thai baht, US dollar, euro, Japanese yen, renminbi (Chinese yuan), or in the Bidder's or Manufacturer's home currency only if his currency trading is prevailed at the time of bidding in any international market other than in Bidder's or Manufacturer's home country.

If the currencies quoted by the Bidder do not conform to the requirement set forth herein, EGAT reserves the right to convert the bid price to US dollars by using the exchange rate on the Bloomberg screen which is announced at 10.00 a.m. (Bangkok Time) on the bid opening date. Such converted bid price in US dollars shall be treated as the Bidder's proposed bid price. In such case the Contract Price for such portion under the Contract shall be made in US dollars.

Subject to paragraph a. above, in case the Bidder expects to incur a portion of its expenditures in the performance of the Contract in more than one currency and wishes to be paid accordingly, the bid price shall be expressed in different currencies and the respective amount in each currency together making up the total price.

- b. Local expenditures shall be quoted in Thai Baht.
- c. Payments will be made in the currency or currencies in which the bid prices have been stated.

Source of Supply and Service

- a. Prices for Equipment manufactured in Thailand shall be firm ex-works prices and quoted in Thai Baht. Any import duty and taxes (value added tax included) assessed by the Government of Thailand at the port of entry on imported raw materials or components shall be paid by the Contractor and included in these ex-works prices.
- b. Prices for Equipment manufactured outside Thailand (imported Equipment) shall be firm, stated both on FOB Port of Shipment/Vessel and CFR Thai Port basis, and quoted in currencies specified above. Any import duty, excise tax (if any) and value added tax to be assessed by the Government of Thailand at the port of entry shall not be included in the quoted bid prices.

Prices for the following Equipment manufactured outside Thailand which was imported before the bid opening date shall be firm ex-works and quoted in Thai baht, provided that the Bidder shall submit any document(s) evidencing the importation date of such Equipment:

- ***Power Fuse***
- ***Stationary Battery and Battery Charger***
- ***Insulator for substation***
- ***Cable Termination***
- ***Compression Connector and Miscellaneous Hardware***
- ***Bus Fittings***
- ***Grounding Material***
- ***Substation Miscellaneous***

- c. Prices for services including cost of installation supervisor (if any) shall be firm.
- d. All expenses incurred for the Work specified in Article F-1. Scope of Work shall be included in the quoted Bid Prices.

Price Schedule

The Bidder shall enter a unit price, an amount, or a lump sum price, as required, for every item listed in the price schedule. If the unit price as entered does not conform to the amount entered for the same item, the unit price shall govern. If the sum of the amount entered for individual items does not conform to the total amount entered for these amounts under total bid prices, then the sum of the amount entered for the individual items shall govern.

Where quantity and total price only are required, the unit price shall be taken as the stated total price divided by the quantity specified.

Except for foreign supply, VAT at the prevailing rate shall be filled automatically in the Summary of Bid Price of the price schedule in the Excel file. However, the Contract Price shall include VAT only for the portion of Work which is subject to VAT.

B-3. Bid Security

The original of the bid submitted shall be accompanied with a bid security in the form of a cash deposit, or a cashier cheque issued by a local bank, or a bank guarantee or a letter of guarantee issued only by a local bank or an acceptable financial institution in Thailand, or by a foreign bank counter-guaranteed by a local bank as primary obligor. In case of a cash deposit or a cashier cheque, only Thai baht can be made.

The bid security shall be in a form as per specimen attached or in any other form with essential content in accordance with the specimen, and made payable to EGAT in the amount as specified in Data Sheet. Any bid not being accompanied with bid security shall be rejected. The bid security shall remain in force up to and including ninety (90) Days after the expiry date of the bid validity.

The bid security shall be forfeited in favor of EGAT if :

- a. The Bidder withdraws his bid after the bid is opened; or
- b. The successful Bidder fails for any reason to execute the Contract or to furnish a performance security.

The Bidder may, upon EGAT's request to extend the bid security when it has expired, refuse to do so without forfeiting the bid security. A Bidder granting the request will be neither required nor permitted to modify his bids.

The bid security of unsuccessful Bidder(s) will be returned as decided by EGAT or within thirty (30) Days following EGAT's acceptance of the successful Bidder.

The bid security of the successful Bidder will be returned upon execution of the Contract and after the performance security furnished has been accepted by EGAT.

B-4. Validity of Bids

The validity of the bid shall be as specified in Data Sheet.

In the event EGAT requires the validity period to be extended, EGAT may in writing or by *letter submitted electronically or by electronic mail (E-mail)* so notify the Bidders at least fourteen (14) Days prior to the expiry date of the validity period, in which event any Bidder not agreeing to such request for extension may withdraw his bid by so advising EGAT in writing or by *letter submitted electronically or by electronic mail (E-mail)* prior to the expiry date of the original validity period. If the advice of withdrawal shall not have been received by EGAT prior to the said date, the extension shall be deemed to have been accepted by the Bidder, and the Bidder shall be required to extend the effective period of the bid security accordingly.

B-5. Delivery of Bids

Where bids are submitted by mail, the hour and date of receipt of the bid will be taken as that certified by EGAT. For all bids delivered directly, a receipt will be furnished to the Bidder indicating the place, hour, and date of delivery. Late bids will be returned unopened.

B-6. Withdrawal of Bids

Bids may be withdrawn only on written requests which are received by EGAT prior to the time fixed for the receipt of the bids. Negligence on the part of the Bidder in preparing his bid confers no right for the withdrawal of the bid after it has been opened. Whenever a bid has been withdrawn, it will be returned unopened to the Bidder.

B-7. Interpretation of Bidding Documents before Bid Opening

If a prospective Bidder is in doubt about the true meaning of any part of the Bidding Documents, the Bidder may submit to EGAT a written request for a reply or an interpretation; provided that sufficient time is allowed for a reply to reach the prospective Bidder prior to the date specified for bid opening. An interpretation will be given in the form of a Supplemental Notice furnished to all prospective Bidders. Receipt of all Supplemental Notices shall be acknowledged by each prospective Bidder on the Proposal. Oral interpretation of the Bidding Documents will not be binding.

B-8. Information to be Submitted with Bid

Each Bidder shall submit with his bid the following documents, data and information in English language in addition to any other information called for elsewhere in the Bidding Documents in order to enable EGAT to fully evaluate the Proposal of the Bidder :

- a. Name of manufacturer and country of origin and type or model of Equipment he proposes to furnish.
- b. Data, drawings, catalogue and descriptive materials which will show equipment arrangement, general dimensions, principles of operation, extent of factory assembly, and the materials from which parts are made.
- c. Sufficient references describing the technical experience of the manufacturers, including lists of the Equipment supplied and installed overseas. If possible, certificates issued by the user and/or consulting engineers supporting the said work and record of commercial operation in good condition should also be submitted.
- d. Copies of Auditor's certified balance sheet of the Bidder for the past three (3) consecutive years.
- e. In case the local manufactured Equipment is proposed, the sufficient documentary evidence, if any, showing that the manufacturers have been acknowledged for producing standard product by the Thai Industrial Standard Institute (TISI), Ministry of Industry, or registered with TISI, or ISO 9000 certified by the National Accreditation Council of Thailand (NAC) or obtained the privilege from the Board of Investment or accepted by EGAT for manufacture of such Equipment, is required to be submitted with the Bid.
- f. Sufficient evidence documents clearly demonstrating that a firm/company who changes its name, merges with, or acquires other company/companies, or forms a new company by merging its business unit with those of other companies, and the experience records of the new company clearly demonstrating that it has sufficient evidence of running the business as before.
- g. A statement of proposed minor deviations from the Specifications along with complete specifications and all necessary descriptive literature for any proposed alternative Equipment or procedure, as required under Article B-9. Deviations from Specifications.
- h. Where Proposal Data Forms are provided, the Bidder shall enter all information as directed.

- i. Where the Specifications provide for submission of a sample or samples, the Bidder shall submit same together with his bid.
- j. Joint Venture/Consortium Agreement with a statement that each member of a joint venture/consortium will be jointly and severally responsible and liable for the complete execution of the work (in case the Bidder is a joint venture or consortium).
- k. Confirmation Form of not being a Jointly Interested Bidder with other Bidders and not being a person who undertakes any actions as an Obstruction of Fair Price Competition, and Registration/Non-registration with the Revenue Department as a VAT registrant.

If the Bidder has registered as a VAT registrant, he shall submit EGAT an evidence of VAT registration. On the contrary, if the Bidder is not registered as a VAT registrant, he shall inform EGAT whether he will register as a VAT registrant or not.

In case the Bidder is a consortium, each member of the consortium shall fill in the Confirmation Form provided for consortium Bidders.

- l. Filled-in Documentary List and documents required according to Additional Regulation.
- m. A statement indicating that the parent manufacturer shall certify and be responsible for the design, production process and quality control. This information is required only for the Equipment specified in Data Sheet.

Should the Bidder fail to submit any of the document described above and neglect to submit the same to EGAT within the time as specified by EGAT, such failure shall be sufficient reason for rejection of his bid.

Verbal statements made by the Bidder at any time regarding quality, quantity, or arrangement of Equipment will not be considered.

If alternative Equipment is indicated in the bid, it shall be understood that EGAT will have the option of selecting any one of the alternates so indicated and such selection shall not be a cause for extra compensation or extension of time.

In case the Bidder proposes alternative Equipment, with the condition to supply any one of the alternates so indicated at his option, such bid will be considered conditional and may be considered sufficient reasons for rejection.

B-9. Deviations from Specifications

Unless otherwise provided in the Specifications, the quality of Equipment and workmanship shall comply in all respects with the Standards required under the bidding documents.

If the Bidder proposes any minor deviations from the specifications, he shall submit a statement of each proposed deviation referenced to the particular Article of these specifications, details on the design drawings or article, paragraph and section of referenced standards or specifications. Full details of all minor deviations together with confirmation shall be submitted with the bid in a form provided in Section C. The Bidder shall submit, with his bid, copies of the standards or specifications proposed for his deviations. In case there is no statement in the form provided in Section C in the Bidder's proposal on the proposed deviations, the bid shall be regarded by EGAT as conforming in all respects to the terms and conditions and Specifications as stated in the bidding documents at no additional cost to the bid price.

Notwithstanding the foregoing, it is at EGAT's sole discretion in determining whether any of such proposed deviations is acceptable and in determining whether it is minor or major deviation.

B-10. Rejection of Bids

EGAT reserves the right not to accept the lowest evaluated bid.

Bids shall be strictly based on the Specifications and terms and conditions in the Bidding Documents. Should any bid fail to comply with the terms and conditions stipulated in these Bidding Documents, especially those under Article pertaining to payment or be incomplete, conditional or obscure, or contain additions not called for, or irregularities of any kind, it will be liable to rejection.

EGAT also reserves the right to reject any or all bids submitted without giving reason or to reject the bid from any Bidder who fails to satisfy EGAT that the bid complies with the terms and conditions stipulated in these bidding documents without any non-compliance which is deemed substantial and advantageous over other Bidders.

B-11. Delivery Time

Delivery time required is indicated for each respective Price Schedule in the Proposal section of the Bidding Documents, and shall be carefully observed. However, no preference will be given in the bid evaluation for earlier delivery than the stipulated delivery period.

All bids specifying delivery time later than those indicated may be rejected.

B-12. Evaluation and Comparison of Bids

Bid prices pursuant to Article B-2. Bid Prices will be evaluated as follows :

1. The evaluation of bid prices shall be specified in Data Sheet.
2. Bid prices will be converted into Thai Baht at the selling exchange rates, published by the Bank of Thailand, www.bot.or.th between Baht and other currencies on the bid opening date.
3. The rate of import duty prevailed on the bid opening date will be used for the purpose of bid evaluation of CFR Thai Port Price.
4. The prices to be used for evaluation and comparison purpose shall be as follows :
 1. Ex-works price including VAT for the final sale direct to EGAT for locally manufactured Equipment
 2. CFR Thai Port of Equipment to be imported plus the calculated insurance premium of 0.072% of [CFR price+10% (CFR price)], import duty, excise tax (if any), value added tax to be assessed by the Thai Government at the port of entry for imported Equipment , and 0.6 % of CFR price for customs clearance

The rate of import duty to be used for price comparison shall be as follows:

- a) For Equipment consisting of separate components which are intended to contribute together as a functional unit and imported under partial import entry - using a normal single tariff rate published in the Customs Tariff Decree for such Equipment
- b) For other Equipment and spare parts
 - i) In case any imported Equipment and spare part is proposed from one (1) country of origin for the same item:
 - Country of Origin Under Free Trade Agreement (FTA) – using lower comparing rate between the FTA rate and the normal rate published in the Customs Tariff Decree;
 - Country of Origin Under Non FTA – using a normal rate published in the Customs Tariff Decree.
 - ii) In case any imported Equipment and spare part is proposed from different countries of origin for the same item, a normal rate published in the Customs Tariff Decree for such Equipment and spare part will be used for price comparison.

3. Cost of local transportation including VAT, if any
4. Cost of installation supervisor including VAT, if any
5. Guaranteed losses of Equipment, if any, at the rate as stipulated in the Proposal Data.

Price for optional items, if any, will not be taken into consideration; however, Bidders shall also quote the prices thereof as required.

B-13. Acceptance of Bids

EGAT will not be bound to accept the bid with the lowest indicated cost. EGAT reserves the right to accept the bid which in its judgement is the lowest evaluated bid. In making its selection, EGAT will take into consideration the conformity of the bid to the requirements of the Bidding Documents and Specifications, guaranteed delivery time, the suitability for the purpose intended and whenever applicable, compensating factors will be applied to deviation or departures from Specifications. EGAT will also take into consideration whether the Bidder's experience, organization, facilities and financial resources will assure the successful carrying out of the Work under the Contract within the time specified.

B-14. Appeal

Disqualified or unsuccessful Bidders who see that their disqualification or failure are due to EGAT's non-compliance with EGAT's procurement regulations may appeal to EGAT within fifteen (15) Days from the date of receipt or announcement, whichever comes first, of EGAT's final evaluation result. An appeal shall be made in writing and clearly state the cause of appeal and argument with referred facts or regulations and related documents. Appealing does not constitute a ground for suspending the ongoing procurement process unless EGAT's Governor agrees otherwise.

The Contract or Purchase Order shall not be executed until the period of appeal has ended and there is no appeal. In the event there is an appeal during such period, the Contract or Purchase Order shall not be executed unless EGAT's Governor concurs.

Decision of EGAT's Governor is final and conclusive.

B-15. Award of Contract

The Contract will be awarded as soon as practicable after opening of the bids, to the Bidder with the lowest evaluated bid. EGAT reserves the right to award the Contract on the basis of standards and specifications as proposed by the Bidder, if in the opinion of EGAT, they are considered acceptable.

At the time of execution of the Contract, the successful Bidder shall furnish the performance security in accordance with the conditions of Contract in the specimen of performance security provided in the bidding documents.

Failure to comply with the condition as expressed in the specimen of performance security will lead to withdrawal of award and cancellation of Contract, and in this respect EGAT reserves the right to award the Contract to the Bidder with the next lowest evaluated substantially responsive bid and the Bidder who defaults shall have his bid security forfeited in favor of EGAT.

After EGAT notifies the successful Bidder that his bid has been accepted, EGAT will send the Bidder the Contract Documents incorporating all agreements between the parties not later than ninety (90) Days after confirmation of Letter of Award of Contract.

Promptly but not later than fifteen (15) Days after receipt of the Contract, the successful Bidder shall sign and date the Contract and return it to EGAT.

B-16. Bidder's Responsibility

The Bidder shall be deemed to have carefully examined all of the terms, conditions and Specifications of this Invitation to Bid, and also to have fully informed himself as to all conditions, local or otherwise, affecting the carrying out of the Work of the Contract, and to have formulated an estimate of the facilities available and needed.

The Bidder shall also be liable to any rules and regulations as well as Acts enforced in the Kingdom of Thailand. Failure to do so will be at the Bidder's risk.

B-17. Supplemental Notices

Supplemental Notices to the Bidding Documents may be issued prior to the date of opening of bids to clarify the Bidding Documents or to reflect modifications in the design or Contract terms. Each supplemental notice issued will be distributed to each person or organization to whom the Bidding Documents have been issued. The recipient shall acknowledge receipt of each supplemental notice by signing and returning in a reasonable time the receipt form distributed with the supplemental notice. All supplemental notices issued shall become a part of the Contract Documents.

B-18. Cost of Bidding

Bidders will not be reimbursed for any expenses they may incur in preparing and submitting their bids.

B-19. Cancellation of Bid

EGAT reserves the right not to accept any quantity or item or schedule or package, or to cancel the bid without purchasing any item. Bidders shall not be entitled to claim EGAT for any losses and/or damages in this connection. EGAT also reserves the right to cancel the bid should there be any reasonable grounds that bidder is not in good faith in submitting bid such as submitting false documents.

In case of bid cancellation, EGAT will not be responsible for any losses and/or damages and will not refund payment of Bidding Documents.

DRAFT

SPECIMEN OF BID SECURITY

Whereas.....(hereinafter called "the Bidder") has submitted his bid dated.....for.....(hereinafter called "the Bid") under Invitation to Bid No.....KNOW ALL MEN by these presents that WE.....of.....having our registered office at.....(hereinafter called "the Guarantor") are bound unto Electricity Generating Authority of Thailand (hereinafter called "EGAT") in the sum of..... (in words :) for which payment well and truly to be made to EGAT, the Guarantor binds itself, its successors and assigns by these presents. Sealed with the Common Seal of the said Bank this.....(date).....day of.....(month).....,(year).....

THE CONDITIONS of this obligation are :

1. If the Bidder withdraws his bid during the period of bid validity specified in the Bidding Documents; or
2. If the Bidder, having been notified of the acceptance of his bid by EGAT during the period of bid validity;
 - (a) fails or refuses to execute the Contract, if required; or
 - (b) fails or refuses to furnish the Performance Security, in accordance with the Instructions to Bidders;

We, the Guarantor, unconditionally undertake to pay to EGAT as the primary obligor, up to the above amount upon receipt of its first written demand, without EGAT having to substantiate its demand.

This guarantee will remain in force up to and including ninety (90) Days after the expiry date of the bid validity.

(Signature of the Bank)

DRAFT

**SECTION C
PROPOSAL**

INVITATION TO BID NO. BBS1-SWG-01
PROPOSAL
FOR
SUPPLY OF 230 kV COMPACT SWITCHGEAR
TRANSMISSION SYSTEM FOR HYDRO-FLOATING SOLAR
HYBRID PROJECT BHUMIBOL DAM UNIT 1

C-1. Price Schedule

The undersigned Bidder, having carefully examined the Bidding Documents, hereby offers and proposes to perform the services and to furnish the Equipment on the basis of FOB Port of Shipment/Vessel or CFR Thai Port as specified in the Delivery Schedule and Distribution List for foreign supply or Ex-works delivery for local supply, in accordance with all provisions and conditions as described herein, all for the prices stated in the Schedule(s) attached.

Note : 1. Article C-1. Price Schedule

For imported Equipment, EGAT reserves the right to award the Contract on either FOB Port of Shipment/Vessel or CFR Thai Port basis.

2. Article E-12. Performance Security

The performance security required under Article E-12. Performance Security shall be ten (10) per cent, round up to the nearest whole number, of the Contract Price. Cost for furnishing the performance security shall be spread over the items proposed.

C-2. Penalty for Equipment Not Meeting Guaranteed Characteristics

The losses of Equipment shall be evaluated with the same rate as stipulated in the Proposal Data.

If the Equipment proposed fails to meet the guaranteed characteristics or the price of the measured losses is higher than the price of the guaranteed losses, the Contract price of Equipment shall be reduced by the different amount of the comparison between the price of the measured losses and the price of the guaranteed losses.

C-3. Guaranteed Delivery Time

Delivery Time of Equipment is required as indicated in the Delivery Schedule and Distribution List attached. The undersigned Bidder guarantees to make and to complete the delivery of Equipment proposed as required by EGAT.

Whenever the Equipment in any item are sub-itemized, the Contractor shall endeavor not to make partial shipment/delivery by sub-items.

In case of failure on the part of the Contractor to comply with the provision of the above paragraph, it is hereby understood that the Equipment in such particular items shall be deemed undelivered unless and until each all sub-items have been shipped/delivered.

C-4. Drawing and Document Submission Schedule

Drawing and Document Submission Schedule is required as indicated in Article F-11. Drawings and Documents to be Furnished by Contractor. The undersigned Bidder guarantees to submit all drawings and documents as required by EGAT.

C-5. Estimate of Deliveries

The estimated number of individual shipment/delivery, shipping point or points, estimated delivery date and estimated shipping weights and volumes for each individual shipping will be as follows :

<u>Number of Shipments</u>	<u>Item No.</u>	<u>Shipping Point</u>	<u>Estimated Delivery Date from Shipping Point</u>	<u>Total Weight kg.</u>	<u>Total Volume Cu.m.</u>
-----	-----	-----	-----	-----	-----
-----	-----	-----	-----	-----	-----
-----	-----	-----	-----	-----	-----
-----	-----	-----	-----	-----	-----

C-6. Bid Security

Bid security in the amount of _____,
(in words)
_____ has been deposited with EGAT.
(number)

C-7. Supplemental Notices

The undersigned Bidder certifies that the following Supplemental Notices have been received for the Contract Documents :

Proposal Submission Date _____ Day of _____ A.D. _____

Firm's Name _____

By _____

Title _____

Firm's Address _____

Witness

DRAFT

PART 1: PRICE PROPOSAL

PART 1 : PRICE PROPOSAL

PRICE QUOTATION INSTRUCTIONS

This part of the Bidding Document comprises :

1. Summary of Bid Prices
2. Price Schedules

Cost of Supply of Equipment comprises Foreign Portion and Local Portion. For Foreign Portion, Bidder is allowed to quote price in only four (4) different currencies. For Local Portion, default currency is Baht (THB).

Bidder shall fill in the price schedules in the Excel file(s), item by item. Then, the total prices for each schedule and Summary of Bid Prices will be automatically calculated.

Filling-in the data shall be in accordance with the following instructions :

1. Bidder shall fill in all data required in blue cells of the price schedules - Currency and Unit Price.
2. For local portion, the default is THB.
3. For foreign portion, Bidder shall fill a currency code in a column "Currency".

Remarks: Price Schedules are created in Microsoft Office Excel 2007.

INVITATION TO BID NO.BBS1-SWG-01
SUMMARY OF BID PRICE
SUPPLY OF 230 KV COMPACT SWITCHGEAR
TRANSMISSION SYSTEM FOR HYDRO-FLOATING SOLAR HYBRID PROJECT BHUMIBOL DAM UNIT 1

No.	Description	Currency	Supply of Equipment	Supply of Equipment	Foreign Currency (excluding VAT)	Local Currency (excluding VAT) Baht
			Foreign Supply	Local Supply		
			CFR Thai Port	Ex-works Price (excluding VAT) Baht		
			Amount	Amount		
1	Schedule 1 : 230 kV Compact Switchgear					
BID PRICE				Baht		Baht
VAT				Baht		Baht
SUMMARY OF BID PRICE				Baht		Baht

INVITATION TO BID NO.BBS1-SWG-01
Schedule 1 : 230 kV Compact Switchgear
SUPPLY OF 230 KV COMPACT SWITCHGEAR
TRANSMISSION SYSTEM FOR HYDRO-FLOATING SOLAR HYBRID PROJECT BHUMIBOL DAM UNIT 1

Item No.	Description	Qty.	Unit	Currency	Supply of Equipment				Supply of Equipment		Foreign Currency		Local Currency			
					Foreign Supply				Local Supply		Ex-works Price (excluding VAT) Baht		(excluding VAT)		(excluding VAT) Baht	
					FOB Vessel	Cost of Transportation to Thai Port	CFR Thai Port		Unit Price	Amount						
Unit Price	Unit Price	Unit Price	Amount	Unit Price	Amount	Unit Price	Amount	Unit Price	Amount							
1-1	245 kV 3150 A 50 kA Compact Switchgear as per Ratings and Features RF CW8350(IEC)and Dwg. No.BB2-S-1,total height at terminal of compact switchgear shall be 6.00 m(preferable)	4									XXXXX	XXXXX	XXXXX	XXXXX		
1-2	Local Control Cubicle for CW8350(IEC)for Item No.1-1*	4									XXXXX	XXXXX	XXXXX	XXXXX		
1-3	Steel Supporting Structure for CW8350(IEC)for Item No.1-1*	4									XXXXX	XXXXX	XXXXX	XXXXX		
1-4	Maintenance Closing Device for CB of Compact Switchgear RF CW8350(IEC)	1	set								XXXXX	XXXXX	XXXXX	XXXXX		
1-5	Special tools and appliances for complete installation and maintenance for CW8350(IEC)	1	set								XXXXX	XXXXX	XXXXX	XXXXX		
1-6	Service of Installation Supervisor of Compact Switchgear Item No.1-1		man day			XXXXX	XXXXX	XXXXX	XXXXX	XXXXX	XXXXX					
	Note : The SF6 gas in a quantity equivalent to 115% of the total equipment actual requirement shall be provided as follows: - 100% of SF6 gas quantity shall be shipped in returnable steel bottles which shall be returned back to Contractor. - 15% of SF6 gas quantity shall be shipped in non-returnable steel bottles which shall become the property of EGAT.															
Total Price for Schedule 1										Baht				Baht		

* The design of supporting structures and LCC for Compact Switchgear shall be verified by Compact Switchgear manufacturer.

INVITATION TO BID NO.BBS1-SWG-01
Service of Installation Supervisor (Schedule 1)
SUPPLY OF 230 KV COMPACT SWITCHGEAR
TRANSMISSION SYSTEM FOR HYDRO-FLOATING SOLAR HYBRID PROJECT BHUMIBOL DAM UNIT 1

Item No.	Description	Qty.	Unit	Currency	Foreign Currency (excluding VAT)		Local Currency (excluding VAT) Baht	
					Unit Price	Amount	Unit Price	Amount
1-6	Service of Installation Supervisor of Compact Switchgear Item No.1-1		man day					

Note:

1. The quoted total man-days for installation supervisor shall be the required number of days for complete installation, erection, field test and commissioning of all equipment as specified.
2. In addition to the quoted total man-days above, EGAT will also pay the following :
 - a. Travelling time from and to Supervisor's home office as well as travelling time from and to the installation site including ten (10) working days of operation, if any, which will be at the same rate as the cost quoted per man-day.
 - b. Airfares round trip economy class between the Supervisor 's home office and Bangkok by the most expeditious and direct route.
3. Local transportation from and to installation site will be provided by EGAT.
4. If the working man-days are less than the quoted total man-days, the payment shall be on the basis of actual man-days.
5. For man-days exceeding the quoted total amount, no payment shall be made by EGAT. Any such additional man-days approved by EGAT shall be paid on the quoted man-days rate.

DRAFT

PART 2: PROPOSAL DATA

COMPACT SWITCHGEAR

FORM PD 163
Aug. 2024

PROPOSAL DATA

PROCUREMENT REFERENCE

SCHEDULE NO.

BIDDER.

ITEM NO.

- a. Manufacturer / country of origin
- b. Type
- c. Applied standards
- d. General rating
 - Rated voltage kV
 - Maximum service voltage kV
 - Rated frequency Hz
 - Power frequency withstand level kV
 - Lightning impulse withstand level kV
 - Rated continuous current A
 - Rated short-time (1s) withstand current for main and earthing circuits kA
 - Rated peak withstand current for main and earthing circuits kA
- e. Type of enclosure
 - Single phase enclosure
 - Three phase enclosure
- f. Material
 - Enclosure
 - Conductor
- g. Conductor connecting piece
 - Type
 - Material
- h. SF₆ Gas
 - Rated filling pressure at 20 °C
 - For circuit breaker compartment kg/cm²
 - For all other compartment kg/cm²
 - Alarm pressure at 20 °C
 - For circuit breaker compartment kg/cm²
 - For all other compartment kg/cm²
 - Minimum functional pressure at 20 °C
 - For circuit breaker compartment kg/cm²
 - For all other compartment kg/cm²
 - Design pressure of enclosures
 - For circuit breaker compartment kg/cm²
 - For all other compartment kg/cm²
 - Operating pressure of pressure relief device
 - For circuit breaker compartment kg/cm²
 - For all other compartment kg/cm²
 - Internal fault Short-circuit current kA
 - Weight of SF₆ gas filling (Complete) kg
 - SF₆ gas leakage rate %/year

(Certified test record shall be submitted together with tender document during the bidding as an evidence for consideration of evaluation)
- i. Rated supply voltage of closing and opening devices and auxiliary circuits Vdc

COMPACT SWITCHGEAR

FORM PD 163
Aug. 2024

PROPOSAL DATA

PROCUREMENT REFERENCE

SCHEDULE NO.

BIDDER.

ITEM NO.

- j. Temperature limitations for
 - Gas dew point °C
 - Buses and connections °C
 - External parts subjected to contact by personnel °C
 - k. Constructional features
 - Mass of the heaviest transport unit kg
 - Length of longest section for transportation m
 - l. Space Heating
 - Install heating W
 - Number of heater
 - Rated voltage V
 - m. Net weight of each compact switchgear kg
- Circuit Breaker**
- a. Type
 - b. Single pole and/or three pole operated
 - c. Number of breaks per pole
 - d. Applied standard
 - e. Rated voltage kV
 - f. Maximum service voltage kV
 - g. First pole to clear factor
 - h. Power frequency withstand voltage
 - Across contacts kV
 - Phase to earth kV
 - i. Lightning impulse withstand voltage
 - Across contacts kV
 - Phase to earth kV
 - j. Frequency Hz
 - k. Current rating
 - Rated continuous A
 - Rated short circuit current at max kV kA
 - Limited overload capacity A
 - l. Interrupting rating
 - Max asymmetrical interrupting current kA
 - 1 s short time current kA
 - Max opening and interrupting time at rated voltage
 - Opening time ms
 - Interrupting time ms
 - Current at max interrupting time A
 - Interrupting time of resistive current ms
 - Mechanism stroke mm
 - Interrupter stroke mm
 - Opening velocity (contact part) m/s

COMPACT SWITCHGEAR

FORM PD 163
Aug. 2024

PROPOSAL DATA

PROCUREMENT REFERENCE

SCHEDULE NO.

BIDDER.

ITEM NO.

- m. Asymmetrical interrupting rating
 - Max asymmetrical interrupting current kA
 - Max interrupting time at 25-100% of asymmetrical interrupting capability ms
 - Max interrupting time below 25% of asymmetrical interrupting capability ms
 - n. Closing rating
 - Closing and latching current at max kV kA
 - Making capacity-peak at max kV kA
 - Closing time at rated operations ms
 - o. Capacitive current
 - Rated capacitance current switching kA
 - Corresponding to max line length of km
 - Rated transient overvoltage factor
 - p. Temperature rise of contacts at nominal current °C
 - q. Operating mechanism

	Closing	Tripping
- Manufacturer type	<input type="text"/>	
- Mechanism type (spring, hydraulic, etc)	<input type="text"/>	<input type="text"/>
- Operating voltage range (min/max)	<input type="text"/> / <input type="text"/>	<input type="text"/> / <input type="text"/> Vdc
- Current rating of coil	<input type="text"/> A	
- Command duration	<input type="text"/>	<input type="text"/> ms
 - r. Reclosing duty cycle
 - s. Rated reclosing time ms
 - t. Spring charged mechanism
 - Model no
 - Motor rating W Vdc
 - Max charging time at rated voltage s
 - u. Stored energy requirements Operation
 - v. Max recharging time after CO operation s
- Disconnecting Switch**
- a. Type
 - b. Number of breaks per pole
 - c. Applied standard
 - d. Rated voltage kV

COMPACT SWITCHGEAR

FORM PD 163
Aug. 2024

PROPOSAL DATA

PROCUREMENT REFERENCE

SCHEDULE NO.

BIDDER.

ITEM NO.

- e. Maximum service voltage kV
- f. Power frequency withstand voltage
 - Phase to earth kV
 - Across the isolating distance kV
- g. Lightning impulse withstand voltage
 - Phase to earth kV
 - Across the isolating distance kV
- h. Frequency Hz
- i. Rated continuous current A
- j. Rated peak withstand current kA
- k. Rated short time (1 s) withstanding current kA
- l. Type of contact
- m. Material of contact
- n. Thickness of silver on contact surfaces mm
- o. Operating mechanism
- p. Operating time
 - Closing s
 - Opening s
- q. Operating and control voltage Vdc

High Speed Grounding Switch

- a. Type
- b. Rated voltage kV
- c. Power frequency withstand voltage
 - Phase to earth kV
- d. Lightning impulse withstand voltage
 - Phase to earth kV
- e. Rated short circuit making current kA
- f. Rated short time (1 s) withstand current kA
- g. Type of contact
- h. Material of contacts
- i. Thickness of silver on contacts surfaces mm
- j. Operating mechanism
- k. Operating and control voltage Vdc

COMPACT SWITCHGEAR

FORM PD 163
Aug. 2024

PROPOSAL DATA

PROCUREMENT REFERENCE

SCHEDULE NO.

BIDDER.

ITEM NO.

Maintenance Grounding Switch

- a. Type
- b. Rated voltage kV
- c. Power frequency withstand voltage
 - Phase to earth kV
- d. Lightning impulse withstand voltage
 - Phase to earth kV
- e. Rated short time (1 s) withstand current kA
- f. Type and material of contacts
- g. Operating mechanism
- h. Operating and control voltage Vdc
- i. Motor Drive mechanism
 - Model no
 - Motor rating W Vdc
- j. Operating time
 - Closing (@min./rated/max. voltage) s
 - Opening (@min./rated/max. voltage) s

Voltage Transformer

- a. Manufacturer/ Country
- b. Type / Model / Catalog No.
- c. Applied standard
- d. Maximum service voltage kV
- e. Voltage ratio
- f. Secondary voltage rating
 - No 1 secondary winding
 - No 2 secondary winding
 - No 3 secondary winding
- g. Burden
 - No 1 secondary winding
 - No 2 secondary winding
 - No 3 secondary winding
 - Simultaneous
- h. Accuracy class

COMPACT SWITCHGEAR

FORM PD 163
Aug. 2024

PROPOSAL DATA

PROCUREMENT REFERENCE

SCHEDULE NO.

BIDDER.

ITEM NO.

Current Transformer

- a. Manufacturer/ Country
- b. Type / Model / Catalog No.
- c. Applied standard
- d. Maximum service voltage kV
- e. Rated Primary Current A
- f. Rated Secondary Current A
- g. No of core
- h. Current ratio
- i. Accuracy class
- j. Continuous thermal current rating factor

Bushing

- a. Manufacturer/ Country
- b. Type / Model / Catalog No.
- c. Applied standard
- d. Maximum service voltage kV
- e. Type of internal insulation
- f. Type of external insulation
- g. Nominal specific creepage distance mm/kV
- h. Cantilever load N
- i. Type of line termination

DRAFT

Manufacturer's successful operation supply record in overseas country for Compact Switchgear

Manufacturer / Country : _____ / _____ For RF No. _____

Customer / Country	Substation	Quantity	Equipment Rating			Applied System Rating			Type / Model No.	Rated filling gas pressure (compartment)		Type of Circuit Breaker		Date of Operation
			Voltage (kV)	Current (A)	Short Circuit Current (kA)	Voltage (kV)	Current (A)	Short Circuit Current (kA)		Circuit Breaker	Other	Type of interrupter of Circuit Breaker (Self blast / Puffer / etc.)	Number of breaks per pole	

The above information is to prove that manufacturer has experience conforming to that required by Article relevant to Eligibility of Bidders.

PART 3: DELIVERY SCHEDULE AND DISTRIBUTION LIST

INVITATION TO BID NO. BBS1-SWG-01
Delivery Schedule and Distribution List
Transmission System for Hydro-Floating Solar Hybrid Project Bhumibol Dam Unit 1
Schedule 1 : 230 kV Compact Switchgear

Item No.	Description	Qty	Job no.	Substation	Delivery Required by EGAT (within months after confirmation of Letter of Award of Contract)
					CFR Thai Port / Ex-works / DDP EGAT's Store
1-1	245 kV 3150 A 50 kA Compact Switchgear as per Ratings and Features RF CW8350(IEC) and Dwg. No. BB2-S-1	3	BBS1-01-S01	BB2	12
		1	BBS1-01-S01	SPARE	12
1-2	Local Control Cubicle for CW8350(IEC) for Item No.1-1	3	BBS1-01-S01	BB2	12
		1	BBS1-01-S01	SPARE	12
1-3	Steel Supporting Structure for CW8350(IEC) for Item No.1-1	3	BBS1-01-S01	BB2	12
		1	BBS1-01-S01	SPARE	12
1-4	Maintenance Closing Device for CB of Compact Switchgear RF CW8350(IEC)	1	BBS1-01-S01	BB2	12
1-5	Special Tools and Appliance for complete installation and maintenance for CW8350(IEC)	1	BBS1-01-S01	BB2	12

Thai Port = BKK Port

DRAFT

**SECTION D
CONTRACT**

CONTRACT
SUPPLY OF 230 kV COMPACT SWITCHGEAR
TRANSMISSION SYSTEM FOR HYDRO-FLOATING SOLAR
HYBRID PROJECT BHUMIBOL DAM UNIT 1

No. _____

This Contract is executed and delivered this _____ day of _____,
B.E. _____ (A.D. _____), between

ELECTRICITY GENERATING AUTHORITY OF THAILAND

represented by _____ of said Authority, hereinafter called "EGAT", and

(Contractor)

represented by _____, age _____ years, nationality _____, hereinafter called
the "Contractor".

EGAT and the Contractor mutually agree as follows :

D-1. Contract Documents

The following documents attached to this Contract are incorporated and made a part of this
Contract, as though fully written out and set forth herein :

Data Sheet

- A. Invitation to Bid
- B. Instructions to Bidders
- C. Contract Price, Delivery Time of Equipment and Proposal Data
- D. Contract
- E. General Conditions
- F. Special Conditions
- G. Ratings and Features
- H. Bill of Materials (None)
- I. Specifications
- J. Drawings
- K. Supplemental Notices

L. Attachments :

M. Changes :

All of the foregoing documents are referred to herein as the Contract Documents. They are also incorporated into this Contract and made a part hereof all codes, designations, standards, standard specifications and similar Equipment which are referred to in the Specifications and Special Conditions.

D-2. Acceptance of Proposal

EGAT has accepted the proposal of the Contractor for furnishing the Equipment in conformity and in accordance with and subject to all the terms and conditions of these Contract Documents.

D-3. Agreement

The Contractor agrees to sell and EGAT agrees to buy the Equipment as described in these Contract Documents.

D-4. Obligation of Contractor

The Contractor agrees to perform well and faithfully all of the services and to furnish all of the Equipment described in these Contract Documents, and to supply and provide all Equipment, labor and other things requisite for or incidental to the said Work.

D-5. Obligation of EGAT

EGAT agrees, subject to the terms and conditions of these Contract Documents, to pay to the Contractor the amount shown, and at the rates and times and in the manner set forth in these Contract Documents.

D-6. Mutual Obligations

EGAT and the Contractor mutually agree to perform, fulfill, abide by, and submit to any and all of the provisions and requirements and all matters and things contained or expressed in, or reasonably to be inferred from these Contract Documents.

D-7. Deposit of Performance Security

The Contractor agrees to deposit with EGAT an acceptable performance security in accordance with the Contract Documents.

D-8. Assignment

The Contract or any part thereof shall not be assigned or pledged without the written consent of EGAT, nor shall the Contractor assign or pledge any money due, or to become due, to him hereunder, without the prior written consent of EGAT.

D-9. Notices

All notices called for by the terms of this Contract shall be effective only at the time of receipt thereof and only when received by the parties to whom they are addressed at the following addresses :

EGAT : Governor
Electricity Generating Authority of Thailand
Bangkruai, Nonthaburi 11130
Thailand

Contractor : _____

All notices called for by the terms of this Contract shall be in the form of registered letters or *letters submitted electronically or electronic mails (E-mails)* in the English language.

D-10. Integration

EGAT and the Contractor agree that this Contract, including the Contract Documents, expresses all of the agreements, understandings, promises, and covenants of the parties, and that it integrates, combines, and supersedes all prior and contemporaneous negotiations, understandings, and agreements, whether written or oral, and that no modification or alteration of this Contract shall be valid or binding on either party, unless expressed in writing and executed with the same formality as this Contract, except as may otherwise be specifically provided in this Contract.

D-11. Counterpart

This Contract is executed in two (2) identical counterparts: one (1) for EGAT and one (1) for the Contractor.

ELECTRICITY GENERATING AUTHORITY
OF THAILAND

CONTRACTOR :

BY _____
()

BY _____
()

WITNESS :

WITNESS :

BY _____
()

BY _____
()

DRAFT

SECTION E
GENERAL CONDITIONS

GENERAL CONDITIONS

E-1. Definitions

Whenever the following terms are used in the Contract Documents, they will have the following meanings :

- EGAT : The Electricity Generating Authority of Thailand, having its Head Office at Nonthaburi, Thailand, and its authorized representative or representatives
- Engineer : Firm or company assigned by EGAT to provide engineering, consulting or construction management services in support of EGAT
- Bidder : Any person or firm or company or joint venture or consortium of firms submitting bid to EGAT for furnishing the services and Equipment described in the Contract Documents, in response to this Invitation to Bid
- Contractor : Any person or firm or company or joint venture or consortium of firms including appointed representatives, successors and assignees thereof, whose bid has been accepted by EGAT for furnishing of the services and Equipment described in the Contract Documents
- Subcontractor : Any person or firm or company (other than the Contractor) to whom any part of the Contract has been sublet, with the consent of EGAT, by the Contractor
- Contract : The agreement between EGAT and the Contractor, and all Appendices and Schedules thereto including Invitation to Bid, Instructions to Bidders, Proposal, General Conditions, Special Conditions, Specifications, Ratings and Features, Drawings, Supplemental Notices and any other documents referred to in, or connected with the Contract, eventhough the said documents are issued after execution of the Contract
- Contract Price : The sum specified in Section C which is inclusive of VAT (if any) subject to such additions thereto or deductions therefrom as may be made under the provisions hereinafter contained

Equipment	:	Machinery, apparatus, materials, goods, including accessories and spare parts to be supplied under the Contract and specifically described in the Specifications
Work	:	All the work to be done by the Contractor for design manufacture, shop test, transportation, and delivery of the Equipment ex-works, FOB Port of Shipment/Vessel or CFR Thai Port or at EGAT's store/site as agreed, including, if required, supervision for installation at site and supervision for field tests of the Equipment under the Contract
Thai Port	:	Commercial ports in Thailand including but not limited to Bangkok Port, Laem Chabang Port, Sriracha Harbour Port, Siam Seaport, Maptaphut Port, Songkhla Port, Phuket Harbour Port or Suvarnabhumi Airport, as the case may be
Bangkok Port	:	Bangkok Wharf (Klong Toey Port) and all other commercial ports in Bangkok Metropolitan area
Supervisor (if required)	:	Contractor's employee assigned as installation supervisor including assistant supervisor, to supervise and be responsible for the installation, erection, adjustment, field tests, and commissioning of the Equipment supplied under the Contract
Option (if any)	:	Equipment to be quoted by the Bidder which EGAT reserves the right to accept or omit in whole or in part
Year	:	Calendar year
Month	:	Calendar month
Day	:	Calendar day

E-2. Intent of Contract Documents

All of the Contract Documents are complementary, and what is called for by one shall be as binding as if called for by all. In the case of any discrepancy between any of the Contract Documents, or any defective description or ambiguity, the matter shall be promptly submitted to EGAT, which shall promptly make a determination in writing. Any adjustment by the Contractor without this determination shall be at the Contractor's own risk and expense. In all cases of discrepancy, defective description, or ambiguities, the interpretation given by EGAT shall be binding on the Contractor, subject to the provisions of Article E-31. Dispute Resolution, included in these General Conditions.

E-3. Applicable Law and Legal Jurisdiction

The applicable law of this Contract shall be the law in force in the Kingdom of Thailand. Should there be any ambiguity or discrepancy arising out of or in connection with the Contract Documents, the interpretation thereof shall be made in accordance with Thai laws. Any litigations between the parties that may arise out of or in connection with this Contract or the breach or termination thereof or the performance of work thereunder shall be submitted to the Court of Thailand for decision, except as may be otherwise specifically provided in these Contract documents.

E-4. Statutory Requirements

Throughout the continuance of the Contract, the Contractor shall conform to all laws of the Kingdom of Thailand, and to all regulations, by-laws, ordinances, or orders made thereunder, and to the lawful requirements of any public, municipal, or other authority, in any way affecting or applicable to the Contractor or its operations.

E-5. Patents and Copyrights

The Contractor shall indemnify and hold EGAT, its officers, agents, and employees harmless against and from liability of any nature or kind, including costs and expenses for or on account of any copyrighted or uncopyrighted composition, secret process, patented or unpatented invention, article, or appliance manufactured, delivered, or used in carrying out the Work under the Contract. All drawings and the information contained therein as well as the use of any process, material or Equipment developed in the course of carrying out the Work under the Contract shall become the property of EGAT where EGAT shall have the right to use any or all of them for any purpose either for present or future projects. For the avoidance of doubt, none of them will be used solely for any commercial benefit which is not related to EGAT work.

E-6. Subcontracts

The Contractor shall not assign or transfer the Contract or any part thereof or any benefit or interest therein or thereunder, any monies due or become due under this Contract to any other person or persons.

The Contractor shall not be allowed to subcontract the whole of the Work under this Contract. Subcontracting of any part of the Work shall be subject to the prior written consent of EGAT. Such consent, if given, shall not relieve the Contractor from full and entire responsibility under this Contract.

If the Contractor desires to subcontract any part or parts of the Work called for by the Contract, he shall notify EGAT in writing to that effect and shall state in such notice the nature and extent of the part or parts of the Work called for by the Contract proposed to be subcontracted and name of the person proposed as Subcontractor. Unless and until written approval is given by EGAT, approval for which shall not be unreasonably withheld, the Contractor shall not subcontract any part of the Work. All requirements specified in these Contract Documents shall be applicable to Subcontractors also.

No contractual relation shall exist between EGAT and the Subcontractors, and the Subcontractors are not to enjoy any privileges conferred on the Contractor by this Contract.

Any Work done by any Subcontractor who has not been approved by EGAT shall be subject to rejection or stoppage of Work by EGAT. In such case the Contractor cannot claim delay or request for time extension of the Contract completion date and/or make financial claim to EGAT.

E-7. Export Charges

All tariffs, duties and other taxes or charges levied by the country of origin of the Equipment shall be paid by the Contractor, and such expenses shall be included in the cost of the Equipment.

E-8. Import Duty and Taxes

EGAT will pay all costs of procuring the necessary permits and licenses for importation into Thailand, and will pay import duty and any taxes including value added tax imposed at the port of entry on the Equipment to be supplied by the Contractor and imported into Thailand for the Work under this Contract.

EGAT will not pay import duty and taxes on either the personal effects of the Contractor's employees, such as personal articles, household furnishings and appliances, and goods of any kind imported for the personal use of the Contractor's employees whether imported by an employee or by the Contractor, or in respect of food, tobacco, liquor and other commissary goods imported by the Contractor or by his employees.

EGAT will not pay import duty and taxes including value added tax on equipment, tools, instruments and machinery imported by the Contractor for purpose of carrying out the work under the Contract. All processes of importation shall be arranged by the Contractor.

Equipment, tools, instruments and machinery which are certified by the Contractor that they are required for installation, test and commissioning of the Work at the site and they are intended for re-exportation can be temporarily exempted from import duty and taxes including value added tax. All Equipment thereof shall be imported under the name of the Contractor and be in accordance with the rules and regulations of the Customs Department of the Kingdom of Thailand.

EGAT will assist the Contractor for such temporary exemption of import duty and taxes including value added tax by issuing a letter confirming such temporary import. Import duty and taxes including value added tax for the temporarily imported Equipment shall be paid by the Contractor to the Customs Department before re-exportation at the rate to be specified by the Customs Department at the time of importation for the whole period they have been imported into the Kingdom of Thailand. Temporary importation of the Equipment is subject to approval of the Customs Department and the deposit of a bond with the Customs Department in the amount to be notified by the Customs Department is required. All costs for submission of information and data if required by the Customs Department and the cost of provision of the bond shall be borne by the Contractor.

In view of numerous advantages, the ATA Carnet system or other systems may be arranged for shipment of the said temporarily imported equipment by the Contractor (if required). Any charge incurred and/or any liability shall be borne by the Contractor.

E-9. Value Added Tax

Pursuant to the Revenue Code of Thailand, EGAT shall be responsible and pay when due for the value added tax imposed on the supply of Equipment, including local transportation (if any) and/or on the provision of services under this Contract. EGAT shall in no case be responsible for the value added tax collectible on any payment made by the Contractor under any subcontract or under any other circumstances and the Contractor shall comply with the rules and regulations of the Revenue Code of Thailand.

In case there is any change on the rate of value added tax imposed by the Government of Thailand, the amount of value added tax comprised in the Contract Price shall be adjusted to reflect such change, provided that the price of the Work shall remain unchanged.

E-10. Income and Other Taxes

Income and other taxes assessed or collected by the Government of Thailand, or any subdivision thereof, or any municipality therein on the Contractor and his employees shall be under the responsibility and account of the Contractor.

In accordance with the Revenue Code of Thailand, should the payment under this Contract be subject to income tax and withholding tax of any kind is required to be withheld by EGAT, such withholding tax shall be deducted by EGAT from each payment and EGAT will be responsible to remit such withholding tax to the Revenue Department of Thailand on behalf of the Contractor. In case any payment being made through the letter of credit or being made directly from foreign source whereby the withholding tax cannot be deducted from payment, the Contractor is required to immediately inform EGAT once each such payment is made to the Contractor, and the withholding tax of which will be paid from EGAT's own fund to the Revenue Department in the same manner as aforesaid. Such withholding tax amount as advanced by EGAT on behalf of the Contractor shall be reimbursed by the Contractor to EGAT within the period of time fixed by EGAT.

In the case where the Contractor considers that the transaction under this Contract is exempted from income tax of Thailand (under any circumstance), the Contractor shall submit, together with his proposal(s), a statement detailing such exemption and the valid documentary evidence. Should EGAT rely on the statement so submitted, no deduction for withholding tax shall be made from payment. However, if the tax authority of Thailand determines that such exemption is not applicable, the Contractor shall then be responsible for the amount(s) equal to the withholding tax, plus the amount(s) of tax exceeding those of withholding tax, including the surcharge and/or penalties imposed on EGAT and the Contractor. The responsibility and liability of the Contractor as provided in the preceding sentence shall survive termination of the Contract.

If the Contractor fails to immediately inform EGAT of the payment as required under the second paragraph preventing EGAT from remitting the withholding tax to the Revenue Department within seven (7) Days from the end of the month in which such payment is made, or fails to pay and/or reimburse EGAT for any amount required under this Article within the period of time fixed by EGAT, such period not to be shorter than fifteen (15) Days from the date of EGAT's notice for payment, EGAT has the right to claim directly from the Contractor or claim from Performance Security or Maintenance Security, as the case may be, or deduct or setoff from any money due to the Contractor under this Contract

for the outstanding amount, surcharge and/or penalty (if any) together with interest at the rate of Minimum Overdraft Rate (MOR) plus two (2) per cent calculated from the due date up to the date the payment is made in full.

EGAT will proceed with the tax matters under the Contract by relying on the information and document submitted by the Contractor in relation to the Bidder's status and tax liability. If the Revenue Department of Thailand differently determines the status and tax liability, the Contractor shall be responsible and liable for any cost and expense, penalty and/or surcharge incurred and/or imposed on him and EGAT in relation thereto.

E-11. Fees and Duties

Any and all immigration fees, stamp duties, and other fees assessed or collected by the Government of Thailand, or by any subdivision thereof, or by any municipality therein, on this Contract, on the Contractor and/or his personnel shall be paid by the Contractor. Any taxes collectible under this Contract, other than those stipulated in this Contract, shall be at the responsibility and account of the Contractor.

The stamp duty for any service contract (Construction, Hire of Work, Consultancy Service, Transportation, Supervisor, etc.) with the Contract value of the service portion lower than baht 200,000.- is required to be affixed by the Contractor on the original copy and the counterpart of the Contract. In case the value of the service portion is baht 200,000.- and over, payment of such stamp duty by the Contractor shall be made in cash to the Revenue Department of Thailand or its authorized subdistrict offices. In either case, the stamp duty is required to be affixed or paid, as the case may be, within fifteen (15) Days after the date of Contract execution, otherwise the Contractor shall be liable to pay for any and all penalties imposed for the delay as required by law.

The Contract value of the service portion to be calculated for stamp duty under this provision shall be the price excluding value added tax.

For a foreign Contractor who has no representative in Thailand, EGAT will, upon receipt of written request from the Contractor, affix or pay for stamp duties from EGAT's own fund on behalf of the Contractor, the Contractor is therefore required to reimburse EGAT for such stamp duties plus any and all penalties imposed by law for delay, if such delay is due to Contractor's failure to make written request to EGAT as aforesaid within a reasonable period of time.

If the Contractor fails to reimburse EGAT for any and all amount as required under this Article within the period of time fixed by EGAT, such period not to be shorter than fifteen (15) Days from the date of EGAT's notice for payment, EGAT has the right to claim directly from the Contractor or claim from Performance Security or Maintenance Security,

as the case may be, or deduct or setoff from any and all money due to the Contractor under this Contract for the outstanding amount together with interest at the rate of Minimum Overdraft Rate (MOR) plus two (2) per cent calculated from the due date up to the date the payment is made in full.

E-12. Performance Security

The Contractor shall, at the time of execution of the Contract, deposit with EGAT a performance security for the due and proper performance of this Contract in the amount of ten (10) per cent, round up to the nearest whole number, of the total Contract Price. The performance security shall insure payment of any obligations, penalty, damages, liquidated damages, or expenses for which the Contractor may become liable to EGAT.

The amount of the performance security shall be adjusted or the Contractor may deposit a new performance security in the amount of ten (10) per cent, round up to the nearest whole number, of the additional Contract Price to cover the Contractor's obligation in case the Contract Price is increased due to change of the Work under the Article E-21. Changes and Extra or Omitted Work.

The performance security shall be in the form of a cash deposit, or a cashier cheque issued by a local bank, or a bank guarantee or letter of guarantee issued only by a local bank or an acceptable financial institution in Thailand, or by a foreign bank counter-guaranteed by a local bank and, made payable to EGAT in the same currency as that of the Contract. In case of a cash deposit or a cashier cheque, only Thai baht portion of the Contract Price can be made. EGAT may at any time, upon application by the Contractor, approve the substitution for any performance security held under this Article by other performance security on such terms and conditions as may be approved by EGAT. The Contractor shall bear the cost of the performance security.

The conditions of the guarantor's obligations in the performance security shall include, inter alia, the following :

- (1) The guarantor shall unconditionally guarantee, as primary obligor and not as surety merely, payment of any obligations, penalties, damages, liquidated damages, or expenses for which the Contractor may become liable to EGAT.
- (2) No extension of time, change in, addition to, or other modification of the terms of the Contract or Work to be performed thereunder, or of the specifications or other Contract Documents shall in anyway release the guarantor from any liability under the performance security, and the guarantor shall thereby waive notice of any such extension of time, change, addition or modification.

- (3) The performance security shall be valid and remain in full effect from the date of execution of the Contract until the issuance of the Acceptance Certificate by EGAT or the acceptance of Equipment deemed to be made by EGAT against submission of the Maintenance Security accepted by EGAT.

Unless and until an official receipt is issued in respect to a security deposit, EGAT will not recognize or accept any such deposit as fulfilling the requirements of this Article. Failure to deposit a performance security at the time specified above in this Article or such extended time as may be approved by EGAT shall be a breach of this Contract and EGAT is entitled to terminate the Contract or suspend any payment for Work performed until the performance security has been accepted by EGAT. EGAT shall not be liable for any losses, expenses and/or damages resulting from such payment suspension.

If any performance security furnished under this Article becomes unacceptable to EGAT, or if any guarantor fails to furnish reports as to guarantor's financial condition from time to time, as requested by EGAT, the Contractor shall promptly furnish such additional or alternative security as may be required by EGAT from time to time to protect the interests of EGAT up to an amount equal to the amount of the security.

In the event of any default or breach of this Contract by the Contractor, EGAT may convert into money any performance security which does not consist of money, and the proceeds shall be deemed to be a cash deposit under this Article. EGAT shall not be liable for any cost, expenses and/or loss incurred in connection with such conversion.

The performance security, in case of a bank guarantee, or letter of guarantee, shall be in conformity with the specimen acceptable to EGAT as shown herein at the end of these General Conditions.

E-13. Inspection and Tests

All Equipment furnished and all Work performed under this Contract shall be subject to inspection by EGAT or EGAT's authorized representatives at its option. While such Work is in progress to ascertain that the completed Work will comply in all respects with the standards and requirements set forth in the Contract Documents. Notwithstanding such inspection, the Contractor will be responsible for the acceptability of the finished Work.

EGAT or EGAT's representatives shall at all times have access to the Work whenever it is in preparation or progress and the Contractor shall provide proper facilities for such access and shall furnish promptly, without additional charge, all facilities, labor and material reasonably needed for safe and convenient inspection by EGAT or EGAT's representatives. The Contractor shall notify EGAT at least two (2) Months in advance

when and where the Equipment and the Work will be available for each inspection and test. Any expense incurred by EGAT or EGAT's representatives to inspect the Equipment and the Work or to attend the test caused by false call of the Contractor for inspection and tests shall be borne by the Contractor.

If any Work should be covered up, or otherwise made inaccessible, without the approval of EGAT, it shall, if required by EGAT, be uncovered and made accessible for examination. Any such cover, which is required in the finished Work, shall be restored to EGAT's satisfaction at the Contractor's expense.

The acceptance of any Work or Equipment covered by these Contract Documents, or the making or waiving of any inspection or witnessing of any tests shall in no way relieve the Contractor of full responsibility for the quality, character and satisfactory operation and performance of the complete Work, and every part of it, as outlined in these Contract Documents, nor shall it prejudice or affect the rights of EGAT as set forth in the Contract.

Unless otherwise specifically provided in the Contract, the expenses directly required for all labor, tools, instruments, other materials and Equipment necessary for performance of the tests shall be borne by the Contractor.

The Contractor shall at his own expense conduct shop tests in accordance with the Specifications and submit the results of the tests to EGAT upon completion of tests. EGAT reserves the right to inspect all Equipment either in person or via video conference during its manufacture or fabrication and prior to its preparation for shipment, to inspect its packing when ready for shipment, and to witness any or all tests.

In the event the results of the tests do not satisfy the requirements of the Specifications or the guaranteed performance, the Contractor shall rectify to improve the Equipment until satisfactory results are obtained and shall conduct all necessary retests at his own expense.

Any delay in delivery due to the retest shall not constitute a release of the Contractor from his responsibility for delay. Any expenses incurred by EGAT in attending these retests shall be borne by the Contractor.

EGAT reserves the right to send one or more of EGAT's employees, not as inspectors, to the Contractor's plant to witness the fabrication, assembly and testing of any or all parts of the Equipment being furnished under this Contract. Travelling expenses and per diem of such employee or employees shall be borne by EGAT.

E-14. Preparation for Shipment and/or Delivery

The Contractor shall submit shipment and/or delivery schedule for EGAT's approval at least thirty (30) Days in advance before each shipment and/or delivery is made. No shipment and/or delivery shall be made prior to EGAT's approval which will be notified to the Contractor within fifteen (15) Days after receipt of the said shipment and/or delivery schedule.

All imported and local Equipment to be delivered under this Contract shall be satisfactorily packaged in such a manner to protect them from damage during transportation and for outdoor storage at the site in hot, wet, humid and dusty conditions. In addition, the imported Equipment shall also be satisfactorily packaged for moist tropical ocean shipment. Where necessary, heavy parts shall be mounted on skids so that cable slings for handling can readily be attached. Where it is unsafe to apply external slings to a package, attached slings shall be provided and shall project through the package so that attachment can readily be made.

In order to keep the damage to non-water proof Equipment during the transportation at minimum level, the Contractor and/or supplier is required to put an umbrella mark on every package of the Equipment.

In order to accelerate the dispatch of the Equipment to the site, the Contractor is required to arrange packaging of the Equipment in such a manner that a complete set of one unit shall be packed in package(s) or crate(s) with indication of designated substation but each individual package or crate shall contain the Equipment for only one unit or part of a complete set of one unit or otherwise as directed in the Instructions for Packaging attached at the end of Section E. General Conditions.

For Power Transformer and Shunt Reactor, in addition, all accessories, which are packed in aforesaid manner shall be contained in a container per transformer except for transformer insulating oil, radiators and conservator including other accessories which for dimensional reason after packaging are unable to be contained in the said container. However, spare parts shall be contained in a separate container per each shipment or Contract to be awarded. The containers to be used shall become the property of EGAT. The dimensions of containers shall be as follows : -

<u>Container Dimensions</u>	<u>Door Dimensions</u>
Height 2.59 m.	Height 2.28 m.
Width 2.44 m.	Width 2.33 m.
Length 6.05 m.	

In addition, details of Equipment and substation destination per container shall be identified in Bill of Lading.

Detailed breakdown prices for spare parts of Equipment shall be also indicated in the invoice.

Prior to delivery of all Equipment, packaging details shall also be submitted to EGAT for approval.

The cost incurred for repair or replacement of any damages to the Equipment due to improper packaging shall be at the Contractor's expense.

Each individual package or crate shall be clearly and plainly tagged or marked for identification as follows:

EGAT, THAILAND

PROJECT NAME : _____

CONTRACT NO. : _____

SUBSTATION : _____

CASE NO. : _____

ITEM NO. : _____

DESCRIPTION : _____

EGAT'S SERIAL NO. : _____ (if any)

In addition to this, the following instructions shall be observed :

- a. Each box, crate, case, bundle or piece of loose Equipment shipped must show the following information clearly marked on its body :
 1. Gross weight in kilograms
 2. Net weight in kilograms
 3. Dimensions in centimeters
- b. All boxes, crates, cases, bundles, loose pieces, etc. must be marked consecutively from No. 1 upward throughout all shipments to completion of the order without repeating the same number.
- c. The packing list must indicate whether shipment is partial or complete, and shall incorporate the following information on each container, etc., according to its individual shipping number:
 1. Export case markings
 2. Case number
 3. Container number (for Power Transformer and Shunt Reactor)
 4. Item number
 5. Gross weight and net weight in kilograms
 6. Dimensions in centimeters
 7. Complete description of Equipment
 8. EGAT's serial No. (if any)

E-15. Clearance and Weight Limitations

The largest unloading facilities at Bangkok Wharf are 35 metric ton cranes. Lifts heavier than 35 tons will have to be handled by ocean freighter on-board lifting equipment. Ocean freighters of the 10,000 tons class regularly calling at Bangkok Wharf have off-loading capacities to handle 50 tons.

The largest unloading facilities at Laem Chabang Port are 30 metric ton cranes. Lifts heavier than 30 tons will have to be handled by ocean freighter on-board lifting equipment.

Generally, unloading at Thai Port and highway transportation are subject to the following limitations:

Dimensions	Limitations		
	Unloading at Bangkok Wharf/ Highway Transportation		Unloading at Laem Chabang Port/Maptaphut Port
Weight (tons)	60.0	>60.0-135.0	120.0
Width (meters)	3.5	3.5	4.5
Length (meters)	10.0	10.0	25.0
Height from Loading Platform (meters)	3.7	4.0	4.0

The Contractor shall therefore exercise due care to pack the Equipment to meet the above transport limitations.

For Power Transformer and Shunt Reactor, the shipping weight of the largest part is indicated in Ratings and Features.

E-16. Shipment

Shipment of Equipment from port of embarkation to the final port of discharge shall be effected by using Thai vessels through the sea freight forwarder appointed by the Contractor. The Contractor is required to notify EGAT of the name of the sea freight forwarder one (1) week prior to shipment.

According to the regulations of *the Maritime Promotion Division*, Marine Department (as amended from time to time), shipments by non-Thai vessels can be made after receipt of permission granted by *the Maritime Promotion Division*, Marine Department as requested by the Contractor.

The Contractor is, therefore, required to immediately contact *the Maritime Promotion Division*, Marine Department for such permission with supporting documents of the case thereof for arrangement of the permission in advance.

The Contractor shall follow all other regulations stated in the Mercantile Marine Promotion Act B.E. 2521 and the regulations of *the Maritime Promotion Division*, Marine Department (as amended from time to time).

The Contractor shall be liable for any and all costs and expenses, losses and/or damages suffered by EGAT as a result of the Contractor's failure to comply with such regulations.

For more information, the Contractor may contact *the Maritime Promotion Division, Marine Department at telephone No. 66 2233 1311-8 extension 387 and facsimile No. 66 2639 4778, <https://maritimepromotion.md.go.th/>*

All imported Equipment shall be shipped on Conference Line or on seaworthy oceangoing vessels which are members or associate members of the International Association of Classification Societies (IACS) and ISM Code Certified Vessels. Vessels over fifteen (15) years of age shall not be used for shipment under this Contract unless they : -

- a) have been used for the carriage of general cargo on an established and regular pattern of trading between a range of specified ports and do not exceed twenty-five (25) years of age, or
- b) were constructed as containerships, vehicle carrier or double-skin open-hatch gantry crane vessels (OHGCs) and have been continuously used as such on an established and regular pattern of trading between a range of specified ports, and do not exceed thirty (30) years of age.

Shipment shall be made under deck except for such Equipment which for dimensional reasons cannot be stowed in the vessels hold. In case Equipment cannot be stowed in the vessel hold, permission shall be obtained from EGAT prior to loading such Equipment on deck. Such approval shall not be unreasonably withheld. The Contractor shall in any case be responsible for proper packing for protection of such Equipment loaded on deck of the vessel. Shipment of all Equipment by dry cargo container will be accepted, but all the incidental expenses shall be borne by the Contractor.

For shipment of Equipment under this Contract, transshipment is allowed.

Any delicate Equipment, materials, instruments and tools including but not limited to computers, electronic parts, etc., shall be shipped by airfreight. The Contractor shall be responsible for proper packing for protection of such Equipment loaded on cargo hold of the aircraft.

Air freight shipment to airport of disembarkation in Thailand shall be effected through the air freight forwarder appointed by the Contractor. The Contractor is required to notify EGAT of the name of the air freight forwarder one (1) week prior to shipment.

E-17. Documents Required for Each Shipment

a. For Seafreight

For accounting procedure, the Contractor is required to send to EGAT the bill of lading, invoice and master packing list immediately by *letter submitted electronically or by electronic mail (E-mail)* but not later than three (3) Days after the Equipment are actually loaded free on board (FOB Vessel) at the port of Shipment.

One (1) original negotiable bill of lading, three (3) original signed invoices and packing lists shall be mailed directly to EGAT by express airmail within four (4) working days after the date of departure of the ocean-going vessel from the port of shipment.

Two (2) original negotiable and five (5) copies of non-negotiable bill of lading, ten (10) original signed invoices and three (3) copies of packing lists shall be submitted to EGAT through the Bank within the time as specified in the letter of credit. - This requirement is applied only in case payment is made by letter of credit.

b. For Airfreight

For accounting procedure, the Contractor is required to send to EGAT the airway bill, invoice and master packing list immediately by *letter submitted electronically or by electronic mail (E-mail)* but not later than three (3) Days after the Equipment are actually loaded on the air carrier at the airport of departure.

Three (3) original signed invoices and packing lists shall be attached to the airway bill and dispatched together with the airfreight shipment.

One (1) copy of airway bill, two (2) original signed invoices and packing lists shall be sent directly to EGAT by courier within four (4) working days after the date of departure of the carrier from the airport.

Two (2) copies of airway bill, ten (10) signed invoices and three (3) copies of packing lists shall be submitted to EGAT through the bank within the time as specified in the letter of credit. - This requirement is applied only in case payment is made by letter of credit.

To act in accordance with the rules and regulations of the Customs Department of the Kingdom of Thailand, as well as to enable EGAT to expedite clearing the Equipment from the Customs House accordingly, the following declarations, other than regular statements, have to be made in English in the invoice for any transaction concluded with EGAT.

- a. Country from which Equipment is purchased as well as country of origin; if the Equipment is produced in the country or group of countries where there are trade agreements between such country or group of countries and the Kingdom of Thailand, preferential treatment on import duty and taxes for importation of the Equipment is required;
- b. Electricity Generating Authority of Thailand as consignee and Thailand as consigning country
- c. Date and Number of Contract;
- d. Name of Project, if any;
- e. Marking and numbers, as well as gross weight and volume;
- f. Details of Equipment, i.e. names, kinds, qualities, quantities, net weights, and other particulars as available for each type including trademarks or other symbols of such Equipment. If there are no trademarks or symbols, the invoice shall indicate "no trademarks", "no symbols", as the case may be;
- g. Selling price or value of Equipment per unit expressed in the type of currency under transaction and representing actual price or value of Equipment as stated in the price schedules or price breakdown, as the case may be;

If the Contractor fails to specify the price or value of Equipment according to the Contract in the invoice prepared for shipment, the Contractor shall be held responsible for the following:

1. In case of over value or price of Equipment stated in the invoice, the Contractor shall be responsible for reimbursement to EGAT for the import duty and taxes (excluding value added tax) collected by the Customs Department and the insurance premium (excluding value added tax) on the over value or price of Equipment as well as interest. Value added tax imposed in connection thereto shall be EGAT's responsibility. The Contractor shall also refund to EGAT the amount of over value payment as well as interest. The interest to be applied under this Article shall be Minimum Overdraft Rate announced by Krung Thai Bank plus two (2) (MOR+2) percent calculated from the date of EGAT's payment of the over value payment, import duty and taxes as well as insurance premium until the date of the Contractor's settlement of the same in full.
2. In case of under value or price of Equipment stated in the invoice, the Contractor shall be responsible for reimbursement to EGAT the surcharges imposed on additional import duty and taxes at the rate currently established by

the Customs Department as well as interest (if any) and also shall be responsible for compensation to EGAT for cost incurred in repair or replacement of the damaged Equipment which is not covered by insurance due to under value or price of Equipment stated in the invoice.

- h. Other expenses:
 - 1. Packing charges (if any)
 - 2. Insurance premiums (if insured)
 - 3. Freight
 - 4. Others (if any)

The Contractor shall, at the time of shipment, prepare and submit a certificate of origin(s) for the Equipment required as per point a. above together with the invoice and other shipping documents for EGAT to obtain the benefit from preferential treatment on import duty and taxes for importation of the Equipment from the country or group of countries where there are trade agreements between such country or group of countries and the Kingdom of Thailand. For each shipment, all items of Equipment requiring certificate of origin shall be included in only one (1) certificate of origin except as otherwise specified in any trade agreement. The trade agreements shall include but not be limited to the following:

- 1. Common Effective Preferential Tariff (CEPT) Scheme for the ASEAN Free Trade Area (AFTA);
- 2. Agreement between the Kingdom of Thailand and Japan for an Economic Partnership; and
- 3. Agreement between the Government of the Kingdom of Thailand and the Government of the People's Republic of China on Accelerated Tariff Elimination under the Early Harvest Programme of the Framework Agreement on Comprehensive Economic Cooperation between ASEAN and China.

If the Contractor advises EGAT in writing before shipment that it is unable to provide a certificate of origin to EGAT, the Contractor shall be responsible for all costs incurred including but not limited to reimbursement to EGAT for the excess amount of the import duty and taxes (except value added tax) paid by EGAT to Customs Department.

Further to the above, if the Contractor delays to provide a proper certificate of origin to EGAT, the Contractor shall be responsible for all costs incurred including but not limited to reimbursement to EGAT for the storage charges and the interest on the excess amount of import duty and taxes (except value added tax) paid by EGAT to the Customs Department at the rate of Minimum Overdraft Rate announced by Krung Thai Bank plus two (2) (MOR+2) percent calculated from the date of EGAT's payment of import duty and taxes up to the date of receipt of the excess amount of import duty and taxes refund from the Customs Department.

However, if the Contractor fails to provide such proper certificate to EGAT, the Contractor shall be responsible for all costs incurred including but not limited to reimbursement to EGAT for the storage charges and the excess amount of import duty and taxes (except value added tax) paid by EGAT to the Customs Department as well as interest on the said excess amount of import duty and taxes at the rate of Minimum

Overdraft Rate announced by Krung Thai Bank plus two (2) (MOR+2) percent calculated from the date of EGAT's payment of import duty and taxes up to the date of acknowledgement that the certificate cannot be issued in conformity with requirement of the Free Trade Agreement.

The Contractor is also required to study the existing trade agreements and any new trade agreement between the Kingdom of Thailand and a country or group of countries published in the website of Customs Department (www.customs.go.th) and/or Ministry of Commerce (www.moc.go.th), and ask for more information from EGAT in order that EGAT can obtain the benefit from preferential treatment on import duty and taxes for importation of the Equipment from the country or group of countries where there are trade agreements between such country or group of countries and the Kingdom of Thailand.

Fullest conformity with the requirements of the Customs Department of the Kingdom of Thailand mentioned above is essential as a condition precedent.

Unless by force majeure, failure to furnish EGAT with these shipping documents and the certificate of origin within the specified period and strictly in accordance with conditions stipulated above thereby causing impossibility of making prompt customs clearance of the Equipment from Thai Port, the Contractor shall, upon receipt of the EGAT's notice, reimburse EGAT for go down rent / storage charge and other expenses arising from or in consequence of the nonconformity with the above specified requirement.

E-18. Force Majeure

The Contractor shall not be in default under this Contract because of any delays in delivery or in completion of the Work on the separable parts thereof which delays are caused by force majeure; provided, that the Contractor shall notify EGAT in writing of the cause of any such delay within fifteen (15) Days after the end of the event which results in the delay. Upon receipt of any such notice of delay, EGAT will promptly ascertain the facts and the extent of the delay and will extend the time for the delivery and assembly of the Equipment or the time for completing the Work when, in the opinion of EGAT, the delay is caused by force majeure or the findings of fact to justify an extension. EGAT's decision shall be binding on the Contractor, subject to the provision of Article E-31. Dispute Resolution included in these General Conditions.

"Force Majeure" shall be defined as any event, the happening or pernicious results of which could not be prevented even though a person against whom it happened or threatened to happen were to take such appropriate care as might be expected from him in this situation. (Normal rains, inundation, dearth of water, and the overturning or sinking of barges in canals, rivers, or streams and similar events shall not be considered as force majeure).

E-19. Transportation Insurance

Transportation insurance from the port of shipment/from the Contractor's premise(s) to EGAT's Store and/or EGAT's site will be under the responsibility of EGAT.

E-20. Transfer of Title

The title of ownership for the Equipment furnished under this Contract shall be passed to EGAT at the time the Equipment is actually loaded onto the vessel at the port of shipment, or into charge of the air carrier at the port of departure, or at the time the Equipment is actually delivered ex-works and the Contractor's statement or delivery order confirming delivery of the Equipment ex-works has been certified by EGAT's representative. However, this transfer of title shall not be construed as an acceptance of the Equipment. The Contractor shall continue to be responsible for the quality and performance of the Equipment, and for their compliance with the Specifications as well as any loss, theft or damage of the Equipment during the course of execution of the Contract, until final acceptance of the Work by EGAT and the fulfillment of the guarantee provision of the Contract.

E-21. Changes and Extra or Omitted Work

EGAT may at any time authorize changes in, additions to, or deductions from the Equipment to be furnished under the Contract. Changes, additions, or deductions shall be authorized only by written notice served by EGAT upon the Contractor and such notice shall be treated as an integral part of the Contract. Adjustments, if any, in the amounts to be paid to the Contractor by reason of any such change, addition, or deduction shall be determined by one or more of the following methods :

- a. by unit price contained in the Price Schedules
- b. by an acceptable lump sum or unit price proposal from the Contractor
- c. on a cost-plus limited basis not to exceed a specific limit. A cost-plus limited basis is defined as the cost of Equipment, labor, and insurance, plus fifteen (15) per cent of the said cost to cover superintendence, general expense, and profit.

No claim for an addition to the Contract Price shall be valid unless authorized as described in this Article. If the parties are unable to agree to the method to be employed in determining adjustments in the Contract Price, the method shall be determined by EGAT.

E-22. Termination and Suspension of Contract

EGAT may, by written notice sent to the Contractor, terminate the Contract, in whole or in part, at any time for its convenience. The notice of termination shall specify that termination is for EGAT's convenience, the extent to which performance of work under the Contract is terminated, and the date upon which such termination becomes effective.

The Equipment that are completed and ready for shipment within thirty (30) Days after the Contractor's receipt of notice of termination shall be purchased by EGAT at the Contract terms and prices. For the remaining Equipment, EGAT may elect :

- a. to have any portion completed and delivered at the Contract terms and prices and/or
- b. to cancel the remainder and pay to the Contractor an agreed amount for partially completed Equipment and for materials and parts previously procured by the Contractor.

E-23. Default and Termination

Should the Contractor :

- a. fail to furnish the Equipment or carry out the Work in accordance with this Contract; or
- b. refuse or fail to prosecute the Work or any part thereof which shall ensure its completion within the time specified in this Contract or any authorized extension of time by EGAT; or
- c. fail to furnish the Equipment and/or complete the Work or any part thereof within the time specified in this Contract or any authorized extension of time by EGAT; or
- d. commit any breach or fail to comply with any of the provisions of this Contract; or
- e. notify EGAT in writing that the Contractor is unable or unwilling to furnish the Equipment or complete the Work or any part thereof; or
- f. become insolvent or bankrupt or make an arrangement or composition with the Contractor's creditors or, being a corporation, go into liquidation whether compulsory or voluntary (except for the purpose of reorganization); or
- g. by himself or by any person on his behalf, give or offer any money or benefit of forbearance to any employee of EGAT and/or any employee of the Engineer who has duties or responsibilities in connection with the acceptance of the proposal or the making of this Contract;

then, in any of such events, the Contractor shall be in default under this Contract, and EGAT may at his sole discretion take any one or more of the following actions that it considers appropriate :

- (i) suspend payments under this Contract until the default has been rectified;
- (ii) cancel or terminate the Contract in whole or in part;
- (iii) take that part of the furnishing of Equipment or the Work, in respect of which the delay or default has occurred, out of the hands of the Contractor or any other person in whose control or possession it is;
- (iv) reduce the Contract Price by an amount equal to the reduction in value to EGAT of the Equipment as actually delivered.

The Contractor shall be liable for all losses and/or damages including but not limited to the increased installation costs and increased administrative costs, suffered by EGAT as a result of the Contractor's default. The Contractor shall have no claim for payment with respect to Work thereafter performed.

All such damages may be recovered by EGAT from the Contractor in any court of competent jurisdiction or, without prejudice to that right, by deduction from any money due or becoming due to the Contractor under this Contract, or from any security deposited, or, after use of the property and materials of the Contract for completion of the work, as provided in this Contract, such property and materials may be sold and the proceeds shall be applied to any remaining obligations of the Contractor.

E-24. Indemnification by the Contractor

The Contractor shall fully indemnify and hold harmless EGAT and its employees and officers from and against any and all suit, actions or administrative proceedings, claims (including any claim for copyright or patent infringement), demands, losses, costs, expenses (including attorney's fees and expenses) and damages of whatsoever nature except breach or default, in respect of death or injury of any person or loss of or damage to any property caused by any act or omission of the Contractor or the Contractor's own officers, directors, agents, employees, Contractors or Subcontractors arising in any manner whatsoever, except any injury, death or property damage caused by the negligence of EGAT, its contractors, employees, officers or agents.

E-25. Limitation of Liability

The liability of the Contractor to EGAT arising from default or termination under the Contract in aggregate shall not exceed the total Contract Price.

E-26. Consequential Damages

Neither party shall be liable to the other party for any indirect, incidental, consequential or punitive damages as a result of the performance or nonperformance of the obligations imposed pursuant to this Contract, unless such indirect, incidental, consequential or punitive damages are foreseen or could have been foreseen at the time of execution of the Contract.

E-27. Vesting of Contract in Receiver

If the Contractor shall compound with his creditors, or shall become bankrupt or insolvent, or carry on business under a receiver, or become incapable from any cause whatsoever of carrying out the Work, any such receiver or any person in whom by law the Contract shall become vested, shall forthwith give notice to EGAT of the fact that the Contract has become vested in it and shall take all reasonable steps to carry on the Work at a rate fulfilling the Contract requirements. Thereupon, if EGAT so desires, such receiver or other such person as aforesaid shall have the option, during the period of one (1) Month from the date when the Contract becomes so vested in it, of carrying out the Contract. In the event of the Work being stopped, this option shall be opened only for a period of fourteen (14) Days from the stoppage date. In the event of the receiver or such other person not electing to carry out the Contract or EGAT not approving the carrying out of the Contract by the receiver, the Contractor shall then be in default and EGAT may proceed in accordance with Article E-23. Default and Termination.

E-28. Extension of Time

If, by reason of any of the following :

- a. Negligence or default on the part of EGAT or its agents,
- b. Alteration in or addition to the Work,
- c. Suspension of the Work at the written direction of EGAT for reasons beyond the control of the Contractor,
- d. War, insurrection, riot or civil commotion or delay caused thereby,
- e. Strikes, not caused by the Contractor's management,
- f. Lawful order of civil or military authorities,
- g. Unusually natural calamities, acts of God,
- h. Any other unforeseen circumstance beyond the Contractor's control.

The Contractor claims that he has been unduly delayed in the progress of the Work, he shall make written request to EGAT for an extension of time for completion of the Work or any portion of it.

Should EGAT consider such claim to be valid, it will grant such extension of time as may seem reasonable to EGAT, without thereby prejudicing or in any manner affecting the validity of the Contract. No extension of time will be granted unless the Contractor makes the written request within fifteen (15) Days after the end of the event which results in the delay.

Other than claiming an extension of time for completion of the Work or any portion of it, the Contractor shall not have any further recourse or claim against EGAT, nor shall he have any right of action against EGAT for loss or damage suffered by reason of such delay.

E-29. Failure to Meet Requirements

EGAT shall have the right to require the Contractor to make any changes in the Equipment or Work covered by this Contract, which may be necessary in the opinion of EGAT, to make the Equipment or Work conform to the requirements of the Contract Documents, without additional cost to EGAT. Any defects in the Equipment or workmanship or other failure, to meet the requirements of the Contract, including errors and omissions on the part of the Contractor, which are disclosed prior to final payment or prior to acceptance by EGAT,

or after completion of all tests, whichever occurs at the later date, shall, if so directed by EGAT, be corrected or replaced promptly by the Contractor at the expense of the Contractor.

In case of replacement of Equipment due to non-conformity with EGAT's specifications and/or defects found prior to acceptance of Equipment by EGAT or replenishment for short pack or returning of repaired Equipment due to such defect, the Contractor shall, upon receipt of EGAT's written notice supported with the receipt issued by the relevant parties, be responsible for reimbursement of the expenses incurred for the following :

- All re-export charges (if any)
- Import duty and taxes
- Landing charges, rents and handling charges (ocean freight)
- Storage charges (air freight)
- Truck hire
- Labour charges

These expenses shall exclude value added taxes, which will be EGAT's responsibility.

The contractor shall be also responsible for reimbursement of Service charges for customs clearance (if any) including value added tax.

Any latent defects not disclosed prior to the date of final payment or prior to acceptance or after completion of all tests, whichever occurs at the later date, but disclosed within the guarantee period as specified in Article F-10.a., shall be corrected or replaced promptly by the Contractor at the expense of the Contractor, except that the cost of import duty and taxes, inland transportation and installation of the replacement parts for foreign supply Equipment, and the cost of inland transportation and the installation of the replacement parts for local supply Equipment will be borne by EGAT.

For Equipment specified in Data Sheet, in case EGAT, at its sole discretion, requires the Contractor to replace any defected Equipment, the Contractor shall replace the Equipment with the whole new set at its own costs and expenses including the cost of all re-export charges (if any), import duty and taxes, landing charges, rents and handling charges (ocean freight), storage charges (air freight), truck hire, labour charges, service charges for customs clearance, inland transportation and installation of the Equipment.

The Contractor shall extend the provisions of his liability to cover all repair and replacement parts furnished from the day immediately following the date of completion of such repair or replacement as follows:

Time of Malfunctioning and/or Defect Found	Guarantee Period Extension				
	Equipment with 1-Year guarantee period	Equipment with 2-Year guarantee period	Equipment with 3-Year guarantee period	Equipment with 4-Year guarantee period	Equipment with 5-Year guarantee period
First Year	For a new period of one (1) Year.	For a new period of two (2) Years.	For a new period of three (3) Years.	For a new period of four (4) Years.	For a new period of five (5) Years.
Second Year	n/a	For a new period of one (1) Year.	For a new period of two (2) Years.	For a new period of three (3) Years.	For a new period of four (4) Years.
Third Year	n/a	n/a	For a new period of one (1) Year.	For a new period of two (2) Years.	For a new period of three (3) Years.
Fourth Year	n/a	n/a	n/a	For a new period of one (1) Year.	For a new period of two (2) Years.
Fifth Year	n/a	n/a	n/a	n/a	For a new period of one (1) Year.

The Contractor shall, if required by EGAT in writing, search under the directions of EGAT for the cause of any defect, imperfection or fault appearing prior to the acceptance of Equipment or in the period of maintenance guarantee. Unless such defect, imperfection or fault shall be one for which the Contractor is liable under the Contract, the cost of the work carried out by the Contractor in searching as aforesaid shall be borne by EGAT. If such defect, imperfection or fault shall be one for which the Contractor is liable under the Contract, the cost of the work carried out in searching as aforesaid shall be borne by the Contractor and he shall in such case repair, rectify and make good such defect, imperfection or fault at his own expense.

E-30 Operation or Use of Unsatisfactory Equipment

If the operation or use of the Equipment proves to be unsatisfactory to EGAT, EGAT shall have the right to operate and use such Equipment until they can be taken out of service for correction by the Contractor of such latent defects, error, or omissions and for replacement in whole or in part, if correction is unsuccessful or infeasible. The period of such operation or use shall not exceed one (1) Year from the day immediately following the date of acceptance of Equipment by EGAT.

E-31. Dispute Resolution

Any dispute arising out of or in connection with this Contract, interpretation, breach, or termination thereof shall be settled by amicable discussion between authorized representatives of each Party. Either Party may at any time send a written notice to the other Party requesting for an appointment of authorized representative for a settlement of any dispute hereunder. The Parties agree to make diligent and good faith attempt to resolve such dispute in an equitable manner. If the authorized representatives of both Parties are unable to resolve such dispute within 30 Days after commencement of the discussion for dispute resolution or other extended period of time as mutually agreed by both Parties, either Party may file a lawsuit to the court having jurisdiction in Thailand for settlement of such dispute. Each Party agrees that the final court judgment shall be conclusive and binding upon the Parties.

Pending decision of the court, both Parties shall continue to perform their respective obligations under this Contract.

E-32. Language and Numbers

All drawings, designs, specifications, manuals, nameplates, markings, operating instructions, statements, schedules, notices, documents, and all written communications between EGAT and the Contractor, concerning this Contract, shall be in the English language and in the metric system of weights and measures unless otherwise specified.

SPECIMEN OF GUARANTEE

To :

Date

Electricity Generating Authority of Thailand
Bangkruai, Nonthaburi, 11130

Thailand

Re : Performance Security for Contract No. _____

Gentlemen :

In accordance with the provision of the Contract for _____ No. _____ (hereinafter referred to as the Contract) the contents of which have been noted by us that Messrs. _____ (hereinafter referred to as the Contractor) has to deposit with Electricity Generating Authority of Thailand (hereinafter referred to as EGAT) a Performance Security for the proper and faithful performance of the Contract in the amount of _____ (in words : _____) which is _____ per cent, round up to the nearest whole number, of the total Contract Price, we, the _____ as instructed by the Contractor, agree unconditionally to irrevocably guarantee as primary Obligor, the payment to EGAT on its first demand, without whatsoever right of objection on our part and without its first claim to the Contractor, in the amount not exceeding : _____ (in words : _____) in the event the obligations expressed in the above mentioned Contract have not been fulfilled by the Contractor, giving EGAT the right of claim for penalty, damages, liquidated damages or any expenses for which the Contractor may become liable to EGAT under the Contract.

We further agree that no extension of time, change in, addition to or other modification of terms of the Contract or Work to be performed thereunder, or of the Specifications or other Contract Documents, which may be made between EGAT and the Contractor, shall in any way release us from any liability under this guarantee, and we shall thereby waive notice of any such change, addition or modification.

This Performance Security shall be valid and remain in full effect from the date of execution of the Contract until the issuance of the Acceptance Certificate by EGAT or the acceptance of Equipment deemed to be made by EGAT against submission by the Contractor of the Maintenance Security accepted by EGAT.

Yours very truly,

Authorized Signature

Instructions for Packaging

Name of Equipment	Packed per complete set of one unit/units	Packed per Substation
1. Power Transformer	√(1)	-
2. Distribution Transformer	√(1)	-
3. Shunt Reactor	√(1)	-
4. Surge Arrester	√(1)	-
5. Current Transformer	√(1)	-
6. CC, CCVT, VT	√(1)	-
7. GIS	-	√
8. Shunt Capacitor Bank	-	√
9. Power Circuit Breaker	√(1)	-
10. Disconnecting Switch	√(1)	-
11. AC/DC Dist. Board, LCUS, LRP	√(1)	-
12. Stationary Battery	√(1)	-
13. Lighting Fixture	-	√
14. Identification and Danger Notice Plate	-	√
15. Control and Protection System	√(1)*	-
16. Computerized Control System	-	√
17. Power Line Carrier	-	√
18. Teleprotection	-	√
19. Line Trap	-	√
20. Battery Charger	√(1)	-

- Note :**
1. Number in parenthesis represents maximum number of complete set of one unit/units packed in an individual package or crate.
 2. * In case of spare for control and protection system, such Equipment shall be packed per board, but in case of loose control and protection system, such Equipment of whichever substation shall be packed in the same package or crate of that substation.
 3. Other substation Equipment not mentioned shall be packaged in such a manner that it will not cause unreasonable expenses or delay to EGAT in distribution of such Equipment to the designated substation.
 4. Prior to delivery of all Equipment, packaging details shall be submitted to EGAT for approval.

DRAFT

SECTION F
SPECIAL CONDITIONS

SPECIAL CONDITIONS

F-1. Scope of Work

The Contractor shall perform, furnish and deliver the Equipment as required by these Contract Documents.

For imported Equipment, Transportation from Thai Port to sites shall be EGAT's responsibility. However, the Contractor shall, at his own expenses and responsibility, perform unloading the Equipment at the port or airport of disembarkation in Thailand.

For local supply, Transportation from the Contractor's premises to the sites shall be EGAT's responsibility. However, the Contractor shall, at his own expenses and responsibility, perform loading the Equipment on EGAT's trucks or trailers at the Contractor's premises and shall be liable for all losses and/or damages to the Equipment as well as any expenses causing therefrom.

F-2. Responsibility of Contractor

The Contractor shall be solely responsible for ensuring that the Work throughout is executed in the most substantial, proper and workmanlike manner, with the best quality materials and conforming to the best engineering practice for the operating conditions specified; the drawings and quality control are performed or made in accordance with the Contract; and services reasonably to be furnished though not specifically provided in the Contract are furnished; all to EGAT's entire satisfaction notwithstanding that certain portions of the work may be executed by the Subcontractor.

F-3. Cooperation with Other Contractors

The Contractor, if required, shall exchange with other Contractor furnishing associated Equipment, all necessary drawings and other information required to insure the complete and proper design and manufacture of the Equipment to be furnished under these Specifications. One (1) copy of all drawings and correspondence, relating to information interchanged between Contractors, shall be sent to EGAT in Nonthaburi, Thailand.

***F-4. Supervision of Installation**

Subject to the desire and decision of EGAT, the Contractor may be required to furnish the services of qualified and experienced supervisor(s) who has at least three years experience on the particular Work required under the Contract and shall be the permanent employee of the manufacturer of the Equipment. For 230 kV (or lower) Power Circuit Breaker and 115 kV (or lower) Gas-Insulated Switchgear, the permanent employee of the representative of the manufacturer is acceptable, provided that such employee is certified by the manufacturer.

The scope of responsibility of the supervisor on behalf of the Contractor is as follows :

- a. Supervise and be responsible for the installation, erection, adjustment, field test and commissioning of the Equipment.
- b. Prepare formulation sheets for a check list, test sheet, release form and field report to be discussed with EGAT before performing the installation work.
- c. Submit four copies of report summarizing the work performance, from the beginning to the completion of the supervisory period, to EGAT within one month after finish the installation work or final inspection. The report shall include the following :
 1. Note on pending matter i.e. faulty and omitted equipment, performance deficiency etc.
 2. Problem concerning installation performance.
 3. Photographs showing progress of the installation work periodically until the work is completed.

The Contractor shall, in each and every instance, cooperate fully with the construction personnel installing and/or operating the Equipment and the Work, the operations of the supervisor shall be coordinated with the program of construction at the site as directed by EGAT.

The supervisor shall report at EGAT in Nonthaburi, Thailand, on the date designated by EGAT after a reasonable advance notice from EGAT, and shall remain until the Equipment have been in satisfactory operation for at least ten (10) working days as determined by EGAT, unless released earlier by EGAT.

The installation supervisor must be able to understand, speak, read and write the English language fluently. Should an interpreter be necessary, the cost of such interpretation service shall be at the Contractor's expense.

*If installation supervisor is required as specified in Price Schedule, this provision shall apply to this Contract.

F-5. Acceptance Tests

After the Equipment have been installed and placed in satisfactory operation, they may be tested by and at the expense of EGAT to determine whether or not all requirements of these Contract Documents have been met and the Contractor's guarantees have been fulfilled. The Contractor will be permitted to have his representative present at his own expense. If the tests show that the requirements or guarantee have not been met, the Contractor shall, at his own expense, make all necessary corrections. Additional tests will then be made to demonstrate to EGAT's satisfaction the effectiveness of these corrections. These additional tests will be at the Contractor's expense. Unless the necessary corrections have been made, the conditions of the Contract shall be considered unfulfilled.

All tests will be performed in accordance with the latest applicable Test Codes, unless otherwise stated.

F-6. Failure to Meet Performance Guarantees

If EGAT elects to accept the Equipment which do not meet any performance guarantee or which do not meet other requirements of these Contract Documents, as may be determined by factory test, field test or operation under service conditions, appropriate adjustment will be made of the Contract Price for such Equipment; provided that no such adjustment will be made until after the Contractor has been given a reasonable opportunity to repair, improve, or replace defective Equipment or parts thereof wherever practicable.

F-7. Acceptance Certificate

When EGAT is satisfied with the Equipment or agrees to accept the Equipment under the provision of Article F-6. Failure to Meet Performance Guarantees and there are no major unsettled claims against the Contractor by EGAT, EGAT will issue a written Acceptance Certificate against submission by the Contractor of maintenance security(ies) as specified in Article F-12. Maintenance Security and effective for a period of time as specified in Article F-10.a.

The Acceptance Certificate will list all deficiencies and reservations as a result of the inspection and tests performed, if any.

The purpose of the maintenance security is to guarantee the proper functioning of the Equipment supplied by the Contractor with a provision that the effective period of the maintenance security shall automatically be extended in case that the obligations stipulated in Article F-10. Maintenance Guarantee are not fulfilled.

A form of maintenance security acceptable to EGAT is shown in Article F-12. Maintenance Security.

F-8. Payment

Payment in foreign currency will be made in the currency or currencies in which the price has been stated in the price schedules. The Contractor has to inform EGAT the mode of payment he requires for payment for foreign currency portion together with detail of bank account No., beneficiary's name and address etc. If the Contractor requires the payment of foreign currency portion to be paid directly to the suppliers, he has to inform EGAT which portion of the Contract Price, as stipulated in the term of payment of the Contract, to be paid accordingly. In case the local Contractor requires foreign currency or currencies to be paid directly to him, payment of such foreign currency or currencies will be made to the local Contractor in Thai Baht by using the selling exchange rate published by the Bank of Thailand on the payment date.

In case the Contractor requires the payment of foreign currency portion to be made through letter of credit, EGAT will, if there is no fault or any delay caused by the Contractor, establish the letter of credit in the name of the Contractor or Suppliers not later than thirty (30) Days after signing the Contract. The Contractor shall be responsible for all bank charges inside and outside Thailand and including opening, amendment, reimbursing charges, payment commission, cable charges, discrepancy fee, acceptance commission and others (if any) arising from Letter of Credit.

Payment in local currency will be made directly by EGAT.

The Contractor or beneficiary has to inform EGAT by mailed letter or *letter submitted electronically or by electronic mail (E-mail)* immediately the date upon which he has received the original letter of credit *to be* opened in his favour.

Payment will be made in the following manner :

a. Payment for Equipment (except Spare Parts and Optional Items)

Foreign Supply

1. Eighty (80) per cent of the Contract Price will be paid after delivery FOB Port of Shipment (FOB Vessel) on the basis of pro rata value of each shipment against presentation of invoices, shipping documents, EGAT's letters of approval for shipment and EGAT's letter of approval for test report* of the relevant Equipment including EGAT's letter(s) of approval for final drawings only for Control and Protection Equipment.

*Test report means the report of tests specified in Article E-13. Inspection and Tests.

2. Ten (10) per cent of the Contract Price of each Schedule will be paid against presentation of Drawing and Document Acceptance Certificate to be issued by EGAT to certify the receipt of all drawings and documents required from the Contractor under Article F-11. Drawings and Documents to be Furnished by Contractor for such schedule, provided that payment shall not be made until EGAT has received from the Contractor the original signed negotiable Bill of Lading and appertaining documents giving evidence of shipment of the main Equipment of that Schedule.
3. Ten (10) per cent of the Contract Price of each Schedule will be paid after the Equipment have been installed, tested and operated or used for a period of 30 Days and the acceptance of the said Equipment has been made by EGAT against presentation of Acceptance Certificate to be issued by EGAT and submission of maintenance security by the Contractor. EGAT will list the minor pending claim(s), if any, and payment will be made by deducting such claimed amount.

However, if, through no fault of the Contractor or of the Equipment, such installation, test and operation or use of the Equipment are delayed beyond a period of six (6) Months after complete delivery at Thai Port; payment of this ten (10) per cent will be made as soon as possible but not later than the ninth (9th) Month after complete delivery and it shall be deemed as if acceptance of Equipment is made by EGAT at the end of the said sixth (6th) Month and the guarantee period shall start therefrom against submission of maintenance security by the Contractor.

In case there is some minor claim(s) or minor fault of the Contractor, the payment of this ten (10) per cent shall be made by deducting such claimed amount and the guarantee period of this part will start after such minor claim(s) has been settled by the Contractor and acceptance of which has been made by EGAT.

Local Supply

1. Eighty (80) per cent of the Contract Price will be paid on the basis of pro rata value of each delivery against presentation of the Contractor's statement or delivery order confirming the ex-works delivery of Equipment duly certified by EGAT's representative*, EGAT's letters of approval for delivery and EGAT's letter of approval for test report** of the relevant Equipment including EGAT's letter(s) of approval for final drawings only for Control and Protection Equipment.

*EGAT's representative means the authorized EGAT's Store personnel to verify the quantity of Equipment according to the packing list to be delivered to the Site.

**Test report means the report of tests specified in Article E-13. Inspection and Tests.

2. Ten (10) per cent of the Contract Price of each Schedule will be paid against presentation of Drawing and Document Acceptance Certificate to be issued by EGAT to certify the receipt of all drawings and documents required from the Contractor under Article F-11. Drawings and Documents to be Furnished by Contractor for such schedule, provided that payment shall not be made until EGAT has received from the Contractor the statement or delivery order and appertaining documents giving evidence of delivery of the main Equipment of that Schedule.
3. Ten (10) per cent of the Contract Price of each Schedule will be paid after the Equipment have been installed, tested and operated or used for a period of 30 Days and the acceptance of the said Equipment has been made by EGAT against presentation of Acceptance Certificate to be issued by EGAT and submission of maintenance security by the Contractor. EGAT will list the minor pending claim(s), if any, and payment will be made by deducting such claimed amount.

However, if, through no fault of the Contractor or of the Equipment, such installation, test and operation or use of the Equipment are delayed beyond a period of six (6) Months after complete ex-works delivery; payment of this ten (10) per cent will be made as soon as possible but not later than the ninth (9th) Month after complete delivery and it shall be deemed as if acceptance of Equipment is made by EGAT at the end of the said sixth (6th) Month and the guarantee period shall start therefrom against submission of maintenance security by the Contractor.

In case there is some minor claim(s) or minor fault of the Contractor, the payment of this ten (10) per cent shall be made by deducting such claimed amount and the guarantee period of this part will start after such minor claim(s) has been settled by the Contractor and acceptance of which has been made by EGAT.

b. Payment for Spare Parts

One hundred (100) per cent will be paid after complete delivery against presentation of invoices, shipping documents and EGAT's letter of approval for shipment for foreign supply or the Contractor's statement or delivery order confirming the delivery of Equipment ex-works duly certified by EGAT's representative* and EGAT's letter of approval for test report** of the relevant Equipment and the acceptance has been made by EGAT. The guarantee period shall start from the day immediately following the date of the acceptance of the Spare Parts.

*EGAT's representative means the authorized EGAT's Store personnel to verify the quantity of Equipment according to the packing list to be delivered to the site.

**Test report means the report of tests specified in Article E-13. Inspection and Tests.

c. Payment for Optional Items

Payment for Equipment

One hundred (100) per cent will be paid after complete delivery with presentation of invoices, shipping documents and EGAT's letter of approval for shipment and the acceptance has been made by EGAT. The guarantee period shall start from the day immediately following the date of the acceptance of Equipment.

Payment for Mechanical Operation Life Test (if any)

One hundred (100) per cent of the cost of the Mechanical Operation Life Test will be paid after the test has been performed successfully and test report has been accepted by EGAT.

d. Payment for Field Test Cost

One hundred (100) per cent of Field Test Cost will be paid after the test has been performed successfully and the test report has been accepted by EGAT.

e. Payment for Installation Supervisor

Payment for the services of the installation supervisor will be made within thirty (30) Days after his release by EGAT. Payment will be made on the basis of actual working man-days at the quoted cost per man-day up to a maximum equal to the total man-days quoted. For man-days exceeding the quoted total man-days, no payment shall be made by EGAT unless the Contractor can claim for any delays in

the progress of the work caused by EGAT. Any such additional man-days approved by EGAT shall be paid on the basis of the quoted man-day rate.

The number of quoted man-days shall include Sundays and shall cover a seven (7) day workweek, if required by the construction program. The working hours shall be forty-eight (48) hours per week, eight (8) hours per day, the working hours over 8 hours per day if requested by EGAT will be counted as overtime at 1½ times the regular hourly rate.

The amount to be paid for each Day for the services of the supervisor shall include for all salary, subsistence expense, insurance, compensations and personal expense of the supervisor, and all liabilities and responsibilities thereto. EGAT will pay for round-trip economy class air transportation for the installation supervisor between the Contractor's home office and Bangkok by the most expeditious and direct route on trip basis by draft after receipt of the Contractor's invoice supported with the used air ticket of such supervisor. The remission of immigration fees and taxes collectible by the Kingdom of Thailand shall not be paid by EGAT, as described in Article E-11. Fees and Duties.

After each payment is made, the Contractor or beneficiary shall issue and submit the receipt to EGAT at e-mail : FFMS@egat.co.th within three (3) calendar days upon receipt of such payment. The details of receipt shall include but not be limited to the following:

- *Company name and address*
- *The receipt date of payment*
- *Lists of Goods/Services the payment is made for*
- *Payment amount in numbers and in words*
- *Recipient signature*

F-9. Liquidated Damages for Late Delivery of Equipment

In the event of failure by the Contractor to make delivery of any Equipment within the time set forth in the Contract, plus any extension thereof authorized by EGAT as provided in the Contract, such failure shall be a default under the Contract for which the Contractor shall be liable for payment to EGAT as liquidated damages at the rate specified in Data Sheet.

Whenever any Equipment under any item is to be used together with other Equipment in other item as specified in Price Schedule as a complete set or unit, the Contractor shall make sure that they shall be shipped together as a complete set or unit. Failure on the part of the Contractor to comply with this requirement, the liquidated damages for late delivery of partial shipment shall be imposed on the Contractor for the whole amount of the Contract Price of such related items.

Notwithstanding, in case the Contractor fails to make delivery of minor part of any Equipment within the time set forth in the Contract and such late delivery does not have any effect to the performance of the Equipment, the Contractor shall be liable for payment to EGAT as liquidated damages at the rate of one-tenth of one (0.10) per cent of the total price of the minor part of the Equipment not timely delivered for each Day of delay. The price of such delayed minor part of the Equipment shall be determined by EGAT. EGAT shall, at his own discretion, determine whether such late delivery Equipment is the minor part and has any effect to the performance of the Equipment or not.

The payment of such liquidated damages shall not relieve the Contractor of his obligations to complete the Work under the Contract.

In case any Equipment is defective or does not conform to the requirements or specifications of the Contract where replenishment or correction or replacement must be made by the Contractor as per Article E-29. Failure to Meet Requirements, it shall be deemed that such Equipment has not yet been delivered unless such Equipment has been replenished or corrected or replaced, as the case may be, and delivered to EGAT at the delivery point specified in the Contract.

Payment of liquidated damages is contingent exclusively upon late delivery; in no case shall EGAT be required to substantiate any claim for payment of liquidated damages with proof of loss and/or damages. The liquidated damages shall be calculated for each Day of delay until the Equipment is delivered to EGAT excluding a period of time from the actual delivery date at the delivery point set forth in the Contract until the issuance of notification of defect or short pack or out of specification made by EGAT to the Contractor. This sum is payable regardless of the actual loss and/or damages incurred.

The Contractor shall not be liable for liquidated damages in the event of delay caused by force majeure.

F-10. Maintenance Guarantee

- a. The Contractor shall guarantee the proper functioning of the Equipment for a period as specified in Data Sheet from the day immediately following the date of acceptance of Equipment by EGAT; provided, however, that should any malfunctioning and/or latent defect in Equipment under normal use and service be found during the said period, and such malfunctioning and/or defective portion be repaired or replaced as stipulated in (c) and (d) hereinafter, then the guarantee period for such portion shall be extended from the day immediately following the date of completion of such repair or replacement as follows:

Time of Malfunctioning and/or Defect Found	Guarantee Period Extension				
	Equipment with 1-Year guarantee period	Equipment with 2-Year guarantee period	Equipment with 3-Year guarantee period	Equipment with 4-Year guarantee period	Equipment with 5-Year guarantee period
First Year	For a new period of one (1) Year.	For a new period of two (2) Years.	For a new period of three (3) Years.	For a new period of four (4) Years.	For a new period of five (5) Years.
Second Year	n/a	For a new period of one (1) Year.	For a new period of two (2) Years.	For a new period of three (3) Years.	For a new period of four (4) Years.
Third Year	n/a	n/a	For a new period of one (1) Year.	For a new period of two (2) Years.	For a new period of three (3) Years.
Fourth Year	n/a	n/a	n/a	For a new period of one (1) Year.	For a new period of two (2) Years.
Fifth Year	n/a	n/a	n/a	n/a	For a new period of one (1) Year.

The premium for the maintenance guarantee shall be paid by the Contractor.

- b. On the expiration of the maintenance guarantee period and if the Equipment is functioning normally, the Contractor shall thereafter be released of all obligations and responsibilities under the Contract and the maintenance security deposited in accordance with Article F-7. Acceptance Certificate, will be released and returned to the Contractor.
- c. If during the guarantee period EGAT finds any malfunctioning and/or defect in the Equipment, EGAT shall inform without delay the Contractor thereof, stating in writing the nature of the malfunctioning and/or defect, and the Contractor shall promptly commence to repair and make good or replace such malfunctioning and/or defect at the expense of the Contractor, except that the cost of import duty and taxes,

inland transportation and installation of the replacement parts for foreign supply Equipment, and the cost of inland transportation and the installation of the replacement parts for local supply Equipment will be borne by EGAT.

For Equipment specified in Data Sheet, in case EGAT, at its sole discretion, requires the Contractor to replace any defected Equipment, the Contractor shall replace the Equipment with the whole new set at its own costs and expenses including the cost of all re-export charges (if any), import duty and taxes, landing charges, rents and handling charges (ocean freight), storage charges (air freight), truck hire, labour charges, service charges for customs clearance, inland transportation and installation of the Equipment.

- d. If, after the repair or replacement performed in accordance with this Article, such Equipment continues to show malfunctioning and/or defect, EGAT may, at its option, demand further repair or replacement, and reserve the right to claim damages, if applicable, arising therefrom.
- e. If the Contractor fails to take action for starting up the necessary works for repair or replacement within fourteen (14) Days after receipt of EGAT's written notice of defect, the defect will be corrected by EGAT or any third party selected by EGAT at EGAT's discretion, and the cost of the corrections shall be on the responsibility and account of the Contractor.

In the event of an emergency where in the judgement of EGAT the delay resulting from giving formal notice would cause serious loss or damage which could be prevented by immediate action, defects may be corrected by EGAT or a third party chosen by EGAT without giving prior notice to the Contractor, and the cost of the corrections shall be paid by the Contractor. In the event such action is taken by EGAT, the Contractor will be notified promptly and shall assist wherever possible in making the necessary corrections.

F-11. Drawings and Documents to be Furnished by Contractor

EGAT reserves the right to require the Contractor to submit the drawings and documents listed in the tables attached at the end of this Section by the designated dates either by registered airmail for foreign mail and registered mail for local mail and/or by electronic files uploaded via document management system. However, cover letters shall be submitted in hard copy to EGAT.

After the requirement under this Article has been fulfilled by the Contractor, a Drawing and Document Acceptance Certificate will be issued by EGAT to certify the receipt of all required drawings and documents:

a. Drawings

- (1) Drawing Title and Sizes. The title of Contractor's drawing shall also include the followings :

ELECTRICITY GENERATING AUTHORITY OF THAILAND

EGAT's Contract No. _____

Item No. _____

Subs. Name _____

The sizes of the drawings except otherwise specified in the Specification shall be as follows :

<u>Size Designation</u>	<u>Dimensions in MM</u>	<u>Dimensions in Inches</u>
A0	841 x 1,189	(33.11 x 46.81)
A1	594 x 841	(23.39 x 33.11)
A2	420 x 594	(16.54 x 23.39)
A3	297 x 420	(11.69 x 16.54)
A4	210 x 297	(8.27 x 11.69)

- (2) Reference Drawings and Catalogues. General drawings showing principal dimensions and weights of Equipment, including controlling dimensions which affect space and handling requirements.

- (3) Drawings and Data for Approval. The Contractor shall submit for approval checked detail assembly drawings including firm dimensions, foundation details and setting diagrams, physical size and weights of all principal parts, complete operating characteristics and ratings of Equipment, connection and schematic wiring diagrams, descriptive information and any other information sufficient to demonstrate fully that the Equipment to be furnished will conform to the requirements and intent of these Contract Documents.

Schematic diagrams shall indicate the operation and function of all electrical Equipment, accompanied, where necessary, with explanatory notes. Wiring diagrams shall show the external connection required, sufficient for EGAT to complete interconnection cable diagrams.

One print each of the drawings submitted for approval will be returned to the Contractor by EGAT or its authorized representative within thirty (30) Days after receipt at EGAT's office, marked either "Approved",

"Approved Except as Noted", or "Returned for Correction"/"Not Reviewed". The notations "Approved" or "Approved Except as Noted" will authorize the Contractor to proceed with the manufacture of the Equipment covered by such drawing, subject to the correction, if any, indicated thereon. When prints of drawings have been "Returned for Correction"/"Not Reviewed"., the Contractor shall make the necessary revisions on the drawings and shall within thirty (30) Days resubmit drawings for approval in the same manner as before.

Any manufacturing done before approval of the drawings will be at the Contractor's risk. EGAT shall have the right to require the Contractor to make any changes in the design which may be necessary, in the opinion of EGAT, to make the Equipment conform to the requirements and intent of these Contract Documents without additional cost to EGAT. Approval of the Contractor's drawings shall not be held to relieve the Contractor of any part of his obligation to meet all of the requirements of these Contract Documents or of the responsibility for the correctness of his drawings.

- (4) Reproducibles of all final approved drawings shall be made on mylar films.
- b. Report of Shop Test. The Contractor shall furnish certified copies of reports of all tests required of the manufacturer to show compliance with the applicable standards and specifications. The cost of all tests and reports shall be borne by the Contractor.
- c. Instruction Manuals. The Contractor shall furnish complete set of instruction manuals and all final approved drawings (if any) for erection, operation, maintenance and repair of the Equipment, and for identification of parts. The instruction manuals shall be combined, assembled and bound in binders. Each binder cover shall be stamped with proper identification indicating name of Equipment, manufacturer's name and address, EGAT's Contract number, manufacturer's reference, etc.

Prior to the assembly and submittal of the instruction manuals, a proof of the cover lettering and the table of contents shall be submitted in sufficient time for EGAT's acceptance without delaying submittal of the finished manuals.

The CD-ROM (Compact Disc-Read Only Memory) of final drawings, final documents, test report and instruction manual, if required, shall conform to the applicable International Standard Organization 9660 (ISO 9660) and have capacity of approximately 700 Mbytes.

The data in CD-ROM shall be created by the following software :

Drawing

The Contractor shall submit all drawings created by CAD software as follows:

1. MICROSTATION software Version SE or
2. AUTOCAD software Version 2000

Any necessary information supporting the completion of reading files (such as special font etc.) shall be included in CD-ROM.

Documents

The Contractor shall submit all documents in Adobe Portable Document Format File (PDF format) and also Program of Acrobat Reader in order to read the file completely in CD-ROM.

Drawing/Document List

The Contractor shall submit the drawings/documents listing information in work sheets file provided by EGAT in CD-ROM in Microsoft Excel file format.

Drawing list of design drawings, as built drawings, manufacturing drawings shall also be submitted together with the drawings in the CD-ROM.

F-12. Maintenance Security

The Contractor shall provide to EGAT prior to the issuance of the acceptance certificate and as a condition for the release of the payment of the last instalment as specified in Article F-8. Payment, maintenance security(ies) in the amount of ten (10) per cent, round up to the nearest whole number, of the total Contract Price or ten (10) per cent, round up to the nearest whole number, of each schedule, excluding the cost of installation supervisor and cost of test(s), guaranteeing the Contractor's performance of the provision of Article F-10. Maintenance Guarantee. The Contractor shall oblige himself to attend to and replace, during the period of maintenance, all malfunctioning parts and for repair of all defects noted in the Work and communicated to the Contractor in writing by EGAT. In case of extended guarantee of the repaired or replaced Equipment, the Contractor may request for return of the original maintenance security and submit a new maintenance security in the amount of ten (10) per cent, round up to the nearest whole number, of the Contract Price of Equipment under the extended guarantee.

The maintenance security shall be in the form of a cash deposit, or a cashier cheque issued by a local bank, or a bank guarantee or letter of guarantee issued only by a local bank or an acceptable financial institution in Thailand, or by a foreign bank counter-guaranteed by a local bank, and made payable to EGAT in the same currency as that of

the Contract. In case of a cash deposit or a cashier cheque, only Thai baht portion of the Contract Price can be made. EGAT may at its absolute discretion refuse to approve any maintenance security offered or may at any time, upon application by the Contractor, approve of the substitution for any maintenance security held under this Article by other maintenance security on such terms and conditions as may be approved by EGAT.

The conditions of guarantor's obligations in the maintenance security shall include, inter alia; the following :

1. The guarantor shall unconditionally guarantee, as primary obligor and not as surety merely, payment of any obligations, damages, liquidated damages, performance penalties, or expenses for which the Contractor may become liable to EGAT.
2. No extension of time, change in, addition to, or other modification of the terms of the Contract or Work to be performed thereunder, or of the Specifications or other Contract Documents shall in anyway release the guarantor from any liability under the maintenance security, and the guarantor shall thereby waive notice of any such extension of time, change, addition or modification.
3. The maintenance security shall be valid and remain in full effect from the date of acceptance of Work until all obligations on the part of the Contractor under the Contract have been fulfilled.

Unless and until an official receipt is issued in respect to a maintenance security deposit, EGAT will not recognize or accept any such deposit as fulfilling the requirements of this Article. Failure to deposit a maintenance security at the time specified above in this Article or such extended time as may be approved by EGAT shall be a breach of this Contract and EGAT may, at its discretion, retain the payment of the last instalment of the total Contract Price.

If any maintenance security furnished under this Article shall become unacceptable to EGAT, or if any guarantor shall fail to furnish reports as to guarantor's financial condition from time to time, as requested by EGAT, the Contractor shall promptly furnish such additional or alternative maintenance security as may be necessary to satisfy the Contract requirements for a maintenance security.

In the event of any default or breach of this Contract on the part of the Contractor, EGAT may convert into money any maintenance security which does not consist of money, and the proceeds shall be deemed to be a cash deposit under this Article. EGAT shall not be liable for any cost, expenses and/or loss resulting from the conversion of any maintenance security deposit into money as herein provided. The Contractor shall bear the cost of the maintenance security.

The maintenance security, in case of a bank guarantee, or letter of guarantee, shall be in conformity with the following specimen.

SPECIMEN OF MAINTENANCE GUARANTEE

To :

Date :

Electricity Generating Authority of Thailand
Bangkruai, Nonthaburi 11130
Thailand

Re : Maintenance Security for Contract
No. EGAT _____

Gentlemen :

In accordance with the provision of the Contract for _____ No. EGAT _____ dated _____ (hereinafter referred to as the Contract), the contents of which have been noted by us that Messrs. _____ (hereinafter referred to as the Contractor) has to deposit with Electricity Generating Authority of Thailand, (hereinafter referred to as EGAT) a Maintenance Security to guarantee the proper functioning of the _____ of the Contract as specified in Article F-10. Maintenance Guarantee in the amount of _____ (in words : _____) which is ten (10) per cent, round up to the nearest whole number, of the total Contract Price or ten (10) per cent, round up to the nearest whole number, of each schedule of the said Work, excluding the cost of installation supervisor and cost of test(s), we, the _____ as instructed by the Contractor, agree unconditionally to irrevocably guarantee as primary Obligor, the payment to EGAT at its first demand, without whatsoever right of objection on our part and without its first claim with the Contractor giving EGAT the right of claim for penalty, damages, liquidated damages or any expenses for which the Contractor may become liable to EGAT under the Contract.

We further agree that no extension of time, change in, addition to or other modification of terms of the Contract or work to be performed thereunder, or of the Specifications or other Contract Documents, which may be made between EGAT and the Contractor, shall in any way release us from any liability under the Maintenance Security, and we shall thereby waive notice of any such extension of time, change, addition or modification.

This Maintenance Security shall be valid and remain in full effect for a period of _____ (...) Year(s) from the day immediately following the date of the acceptance of Equipment. If necessary, this Maintenance Security shall be extended as specified in Article F-10. Maintenance Guarantee.

Yours very truly,

Authorized Signature

Drawings and Documents to be Furnished by the Contractor
(For All Equipment except Control and Protection Equipment)

The Contractor shall submit by registered mail and/or by electronic files uploaded via document management system with the drawings and other documents listed below by the designated deadlines.

Should EGAT require the Contractor to submit the drawings and documents in electronic files via EGAT's document management system, the Contractor is also required to submit the drawings and documents in Print and CD-ROM at the number of copies listed in the parenthesis below.

Drawings/Documents	No. of copies		Deadline and Remarks
	P	CD-ROM	
Manufacturing and Delivery Schedule	1 (-)	- (-)	Within 60 Days after confirmation of Letter of Award of Contract
Quality Assurance Program (If requested by EGAT)	1 (-)	- (-)	Within 60 Days after confirmation of Letter of Award of Contract
Drawings or Documents "FOR REFERENCE"	4 (2)	- (-)	Within 90 Days after confirmation of Letter of Award of Contract
Drawings or Documents "FOR APPROVAL"	4 (-)	- (-)	Within 60 Days for foundation, steel supporting structure (if any) and within 90 Days for others after confirmation of Letter of Award of Contract
Drawings or Documents "FOR REAPPROVAL"	4 (-)	- (-)	Within 30 Days after receipt of returned approval drawings for correction
Drawings and Documents "FINAL DRAWING or FINAL DOCUMENT"	4 (2) *4 (-)	- (-)	Within 30 Days after receipt of approved drawings
Final Design Data	4 (-)	- (-)	Within 150 Days after confirmation of Letter of Award of Contract
Test Procedure (Factory Test)	1 (-)	- (-)	Within 150 Days after confirmation of Letter of Award of Contract
Test Schedule (Factory Test)	1 (-)	- (-)	Not less than 60 Days before testing for foreign supply Not less than 30 Days before testing for local supply
Test Report (Factory Test)	1 (-)	- (-)	Upon completion of tests
Installation Instruction	9 (7)	5 (5)	60 Days before first shipment/delivery
Instruction Manuals	9 (7)	5 (5)	Before shipment/delivery

Note : P = Print Drawing or Document
 CD-ROM = Compact Disc-Read Only Memory with capacity of approximate 700 Mbytes conforming to ISO 9660

*For Transmission Line Insulator, Hardware Assemblies and Line Accessories, Transmission Line Steel Tower, HTLS Transmission Line Conductor and Invar Transmission Line Conductor.

DRAFT

SECTION G
RATINGS AND FEATURES

G. RATINGS AND FEATURES

G -1. Ratings and Features

The following Ratings and Features sheet is attached hereto and made a part of the Contract Documents:

<u>RF No.</u>	<u>Description</u>	<u>Page</u>
CW8350(IEC)	245 kV Compact Switchgear	G2-G4

DRAFT



Ratings and Features	Designed : via ECM system	Validated : via ECM system	Revision 0	Page 1/2
RF No. CW8350(IEC)	Verified : via ECM system	Approved : via ECM system	Dated : via ECM system	

a.	Type	Outdoor, SF6 gas	
b.	Enclosure	Single phase enclosure	
c.	Rated voltage	245	kV
d.	Number of phases	3	
e.	Rated frequency	50	Hz
f.	Rated Insulation level		
	- Rated short-duration power-frequency withstand voltage, r.m.s.		
	- Phase-to-earth, across open switching device and between phases	460	kV
	- Across the isolating distance	530	kV
	- Rated lightning impulse withstand voltage, peak.		
	- Phase-to-earth, across open switching device and between phases	1,050	kV
	- Across the isolating distance	1,200	kV
g.	Current rating		
	- Rated normal current	3,150	A
	- Rated short-time (1 s) withstand current for main and earthing circuit	50	kA
	- Rated peak withstand current for main and earthing circuit	125	kA
h.	Circuit Breaker		
	- Type of mechanism	Spring Operating mechanism	
	- Rated Insulation level		
	- Rated short-duration power-frequency withstand voltage, r.m.s.		
	- Phase-to-earth, across open switching device and between phases	460	kV
	- Rated lightning impulse withstand voltage, peak.		
	- Phase-to-earth, across open switching device and between phases	1,050	kV
	- Rated normal current	3,150	A
	- Rated short-time (1 s) withstand current	50	kA
	- Rated short circuit breaking current	50	kA
	- Rated interrupting time	3	Cycles
	- Rated short circuit making current	125	kA
	- Rated permissible tripping delay	1	Sec
	- Rated reclosing time	20	Cycles
	- Type of tripping	Single pole and three poles	
	- Rated operating sequence	O - 0.3s - CO - 3 min - CO	
	- Control circuit voltage	125	V _{dc}
	- Max/Min control voltage		
	- Opening coil	137.5/87.5	V _{dc} /V _{dc}
	- Closing coil	137.5/106.25	V _{dc} /V _{dc}
	- External AC power source	400/230 V _{ac} , 50 Hz	



Ratings and Features	Designed : via ECM system	Validated : via ECM system	Revision 0	Page 2/2
RF No. CW8350(IEC)	Verified : via ECM system	Approved : via ECM system	Dated : via ECM system	

- i. Disconnecting Switch Combined with Standard Earthing Switch
- Type Triple pole, Triple throw and Single break
 - Rated Insulation level
 - Rated short-duration power-frequency withstand voltage, r.m.s.
 - Phase-to-earth and between phases 460 kV
 - Across the isolating distance 530 kV
 - Rated lightning impulse withstand voltage, peak.
 - Phase-to-earth and between phases 1,050 kV
 - Across the isolating distance 1,200 kV
 - Rated normal current 3,150 A
 - Rated short-time (1 s) withstand current 50 kA
 - Rated peak withstand current 125 kA
 - Operating mechanism Motor and emergency manual operation
 - Operating and control voltage 125 V_{dc}
- Note: The mechanism of each disconnecting switch combined with standard earthing switch shall be separated.
- j. Voltage Transformer and Current Transformer as specified in Rating and Features of VT and CT for Compact Switchgear Sheet
- k. Terminations
- Entrance Bushing (if any, see Single Line Diagram Drawing)
 - Number per feeder 3
 - Type SF₆ to Air
 - Rated current 3,150 A
 - Rated thermal short-time current 50 kA
 - Rated dynamic current 125 kA
 - Cantilever withstand load 5,000 N
 - Creepage distance ≥6,125 mm
 - Insulation level
 - Power-frequency withstand voltage, rms 460 kV
 - Lightning impulse withstand voltage, peak 1,050 kV
 - Terminal Terminal and Terminal connector suitable for 2x1272 MCM ACSR (supplied by contractor)
 - EMC at $1.1U_r/\sqrt{3}$ RIV ≤ 2,500 μV or partial discharge free
- l. Rated control circuit voltage 125 V_{dc}
- m. Total Height at Terminal of Compact Switchgear (Preferable) 6 m

Voltage Transformer

- for all VTs As specified in DWG. NO. BB2-S-1 Sheet 01/02, 02/02
- Quantity per feeder 3
- Highest voltage for equipment (U_m) 245 kV
- Rated primary voltage (U_{pr}) $230/\sqrt{3}$ kV
- Voltage ratio 1,155/2,000&1,155/2,000 : 1
- Secondary voltage rating
- No 1 secondary winding 115/66.4 V
- No 2 secondary winding 115/66.4 V
- Accuracy class
- No 1 secondary winding 0.2 & 3P
- No 2 secondary winding 0.2 & 3P
- Burden
- No 1 secondary winding 1 VA
- No 2 secondary winding 1 VA
- Simultaneous 1 VA
- Polarity Subtractive

Note: 1) Test for accuracy for both 0.2&3P classes shall be subjected simultaneously for each winding in Routine test.

Current Transformer

- for all CTs As specified in DWG. NO. BB2-S-1 Sheet 01/02, 02/02
- Quantity per phase 1 set
- No of core 5
- Current ratio 300/500/800/1,000/1,200/1,500/2,000/
2,200/2,500/3,000 :1//1//1//1//1 A
- Accuracy class & burden 5P20, 5 VA
- Continuous thermal current rating factor 1.0
- Polarity Subtractive
- Thermal short time current rating for 1 s 50 kA
- Mechanical short time current rating, peak 125 kA

DRAFT

SECTION I
SPECIFICATIONS

I. SPECIFICATIONS

I-1. Specifications

The following specifications are attached hereto and made a part of the Contract Documents :

<u>Specification No.</u>	<u>Description</u>	<u>Page</u>
163 (Jan. 2025)	Compact Switchgear	163.1 – 163.29

Specification No 163

Compact Switchgear

163-1 General. This specification covers the general technical requirements for the design, manufacture, testing at works, supply, supervision of erection and testing at site of the compact switchgear.

Specific ratings, characteristics, features and performance characteristics of equipment not cover herein are shown on the accompanying Ratings and Features sheets.

The compact switchgear shall be supplied together with all auxiliary equipment necessary for a complete installation.

163-2 Material and Workmanship. All materials used in the manufacture of the specified equipment shall be unused, of recent manufacture and of the kind, composition and physical properties be suited to their various purposes and in accordance with the best engineering practices.

Workmanship shall be of the highest grade and conform to the best modern practice for the manufacture of high grade machinery and electrical equipment.

All work shall be performed by mechanics and electricians skilled in their various trades.

The factory welders shall be qualified personnel Materials and process specifications needed for weldings shall meet the applicable requirements. Field weldings of the switchgear are to be avoided to achieve high quality of welding.

Maximum reliability is to be achieved by a minimum amount of erection on site. Sub-assemblies are to be erected and tested in the factory to a maximum extent. The size of the sub-assemblies should only be limited by the transport conditions.

All joints shall be machined and all castings shall be spot faced for bolt heads, nuts and washers. All screws, bolts, studs and nuts shall be metric system.

163-3 Design. The enclosure shall be designed as pressure vessels for the highest pressure that can occur during service.

The enclosure shall be of metal, permanently grounded and capable of withstanding the nominal and transient pressure to with it is subjected in service. Materials used in the construction of enclosures shall be of known and certified minimum physical properties on which calculations and/or proof test are based. The manufacture shall be responsible for the selection of materials and the maintenance of these minimum properties, based on certification of the material supplier, or test conducted by the manufacturer.

The design of all components, particularly those subject to shock or stress reversal, shall incorporate reasonable factor of safety in all cases.

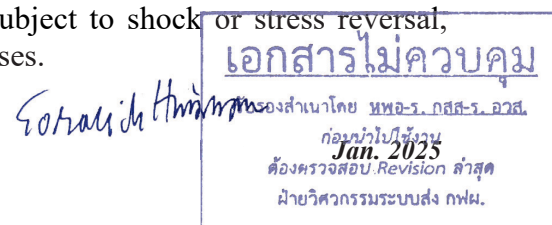

For supervision of the gas the following shall be provided :

- Each compartment shall be equipped with pressure gauge. The pressure gauge for each circuit breaker compartment shall be precisely shows the value of pressure with the Metric Unit of bar. ***Pressure gauge shall be gas-filled type except that oil-filled type pressure gauge is required to cope with the vibration occurred during CB operation.***
- ***The densimeter*** (gas density switch) with two pressure level contacts shall be installed for each phase compartment. A separate gas density switch shall be provided for each gas compartment, so that each can be monitored simultaneously.

If circuit breaker compartment is operated with a rated SF₆ Pressure higher than in adjacent compartment, a third contact for indicating over pressure shall be provided. ***Likewise, the above said third contact shall also be provided for any gas compartment that the rated pressure lower than the adjacent compartment(s).***

The gas density switch shall give an alarm in the first step and third step (if any) for each gas compartment and the second step lock out or automatically trip for the circuit breaker ***and give an alarm for other gas compartments.*** The gas compartments shall be provided separable gas section for density switch testing.

- All connections between gas compartments and gas monitoring devices shall be realised by copper pipes to maximize the operating safety.

The module shall be filled with SF₆ gas. The SF₆ gas shall comply with the requirements of IEC 60376 standard. All the gas seals shall be located at the flanges of the equipment enclosures. The manufacturer shall guarantee that the pressure loss within each individual gas compartment will not be more than 0.5% mass per year under most adverse conditions. SF₆ gas seals shall be tested with a leak detector such as an automatic halogen leak detector or similar instrument.

163-4 Service Conditions. All materials shall be suitable for installation and use at an altitude of 1000 m or less in a tropical climate with the following ambient conditions:

- maximum ambient air temperature: 45°C
- maximum relative humidity: 100%
- Pollution level: class III-Heavy (at least 25mm/kV)
- Installation Outdoor

without corrosion, deterioration or degradation of performance characteristics.

163-5 Codes and Standards. All equipment, materials, devices, fabrication and testing shall conform to the codes, specifications and standards listed below and all applicable codes, specifications and standard referred therein.

Sotrasida Hwinmye

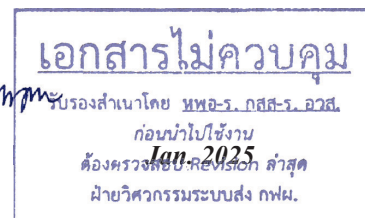

IEC	International Electrotechnical Commission
ANSI	American National Standards Institute
ASME	American Society of Mechanical Engineers
ASTM	American Society for Testing and Materials
AWS	American Welding Society
IEEE	The Institute of Electrical and Electronics Engineers
ICEA	Insulated Power Cable Engineer Association
NEMA	National Electrical Manufacturers Association

All threaded parts requiring external connection shall have UNC screw and pipe threads. All internal parts may have threads in accordance with the established specification in the country of manufacturer.

It is the intent that all equipment, materials, devices, fabrication and testing shall conform to the application codes, specifications and standards even though they are not specifically noted herein. Equivalent codes, specifications and standards established and approved in the country of equipment or material manufacture may be used subject to EGAT's approval. If this election is made, the Bidder shall so state and include in his bid the governing codes, specifications, and standards proposed together with an itemized list of specific deviations from the requirements of codes, specifications and standards referred herein.

The latest issue of all codes, specifications and standards shall govern.

The most stringent requirement, in the event of code, specification or standard conflict, shall govern. This specification shall govern in the event of discrepancies between it and applicable codes, specifications and standards.

163-6 Equipment Requirements

163-6.1 Composition of Switchgear. The following description refers to the attached single line diagram and drawings, which shall be installed and associated with dead tank gas circuit breakers, ~~disconnectors~~, ~~earthing~~ switches, ~~voltage~~ transformers, current transformers, ~~surge arresters~~, insulator, joint boxes, SF6/air bushing or cable termination, ~~control cubicles~~ and necessary support structures.

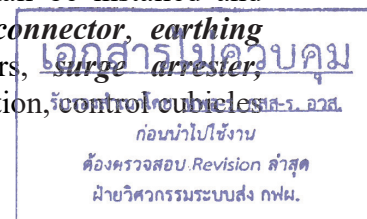

14 กุมภาพันธ์ 2568

163-6.2 Component of Compact Switchgear Equipment. All the components constituting the hybrid integrated multifunctional apparatus must have technology and performance identical to the relevant conventional AIS and GIS equipment in service since long period. Rupture diaphragms shall be provided in each gas compartments to prevent the enclosures from

uncontrolled bursting and suitable deflectors shall provide protection for the operating personnel.

Maximum rated SF₆ gas pressure (gauge) at 20°C shall not be more than 7.0 bar for all compartment.

The module shall be fully pre-fabricated, electrically and mechanically fully pre-tested (i.e. routine tests) at factory. The transport of the module shall be without dismantling of major parts such as circuit breakers, *disconnectors* and current transformers. The module shall be maintained the factory's certifications and therefore no HV tests will be necessary at the site. The module shall be designed in order to require the minimum civil work foundation. Replacement of one phase of the module shall be possible with a minimum down time of the substation.

In the design of the enclosure, heat absorption due to solar radiation shall be considered in accordance with IEC 62271-205.

Dismantling and reassembly of each module can be taken place at any time completely independent of the other.

163-6.3 Circuit Breaker

- a. The circuit breakers shall be designed, rated, tested and manufactured in accordance with applicable portions of IEC 62271-100 or approved equivalent standards, unless otherwise specified. Each power circuit breaker shall be of the 3-pole, electrically release-free (trip free), suitable for remote electrical closing and tripping, as well as for single pole and/or three pole tripping and reclosing (as specified in the Ratings and Features sheets) and furnished complete with operating mechanism and other accessories. The circuit breaker control system shall be completed with the anti-pumping circuit. Mounting wheels will not be accepted. Every types of circuit breaker shall be compatible for the internal inspection at site.
- b. **Interrupting Performance.** The circuit breakers shall be suitable for reclosing duty cycle, as specified in Ratings and Features sheet. Interrupter unit contact current carrying surfaces shall not be subject to deterioration caused by arcing. Arcing contacts faced with arc resistant material sufficient to interrupt circuit breaker full interrupting capability arcs shall be provided. Interrupters unit shall be opened and Arcing Contact shall be replaced for maintenance.
- c. **Control Circuit.** The functional control requirement shall be according to the functional control requirement as shown on the “*CB-CSA TYPICAL SCHEMATIC DIAGRAM*” attached, *regarding to the type of circuit breaker tripping (three pole trip or single pole & three pole trip).*

Sotraside Himmam

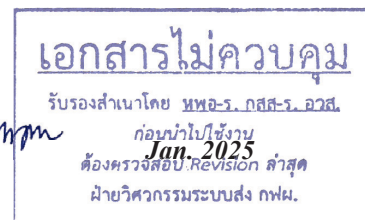

The tripping circuit shall be directly connected to the power supply and two (2) sets of separating current and magnetic circuit tripping coils for primary and back-up tripping.

For single pole and three poles operated circuit breaker, pole disagreement shall be provided.

A pole disagreement sensing circuit for single-pole operated circuit breaker shall be provided that will trip the breaker after a time delay if, after an attempt has been made to close the breaker, one or two of the poles fail to close. The time delay shall be adjustable over a range of approximately 0.1s to 0.5s. A contact shall also be provided for the station alarm.

An auxiliary switch to be supplied shall have not less than twenty extra contacts for the customers use, in addition to those regularly connected in the control circuits by the manufacturer, any one of which may be used as an "a" switch or as a "b" switch. All unused contacts will be wired to the terminal board for external connection. The contact ratings shall be 125 Vdc to 10 A minimum continuous.

d. Operating Mechanism

The operating mechanism shall be motor-operated spring-charged mechanism. Each mechanism shall have two operation counters: One can be reset to zero and the other can not be reset. The operating mechanism shall be mounted and enclosed in a weather-proof housing whose doors are so arranged as to make accessible parts of the mechanism usually requiring inspection or maintenance without removal interrupter or release SF₆ gas from the interrupter.

A position indicator shall be provided *for each mechanism* to show the open and closed positions of the circuit breaker. It shall be positively, mechanically, connected to the mechanism. The indicator shall be of white letter "I" on red background and white letter "O" on green background for closed and open position respectively and shall be located in such a way that visible from the far distance is possible with the mechanism housing closed.

Provision shall be made on each interrupter and its operating mechanism for the attachment of a device to record the operation of valves, contacts, etc., so that timing test can be made to verify the fact that the sequence of operation is as prescribed.

For purposes of inspection and adjustment, means shall be provided for safe manual closing of the breaker at a conveniently accessible place. The maintenance closing device shall be designed for the propose that the contacts can be operated slowly by one man to adjust the breaker when it is not in service. The maintenance closing device shall be provided in the quantity shown in the Price Schedule.

In order to prevent the overcharge of the operating mechanism *from both manual and electrical* operation, some self-protection device shall be provided to prevent damage to the operating mechanism or to slow down the degradation of the equipment. ***Overrun detection can be considered as the over-charge protection for electrical operation as well if the automatic charging-block function is integrated.***

Each operating mechanism shall be provided with its own motor spring charge equipment with a common control cabinet and shall be provided for:

- (a) The time required to charge the closing spring after the closing operation shall be less than 15 s.
- (b) Undervoltage alarm relay with contact suitable for operation on DC circuit to permit remote indication of loss of potential on the supply to the spring charged motor and its controls. Moreover Over-charged and Over-load relay for motor protection are required.
- (c) Spring charged indicator to indicate the state of energy stored in the spring ***which shall be able to be seen easily while performing manual operation.***
- (d) Means shall be provided to prevent the operation of the mechanism when maintenance work is being done. The mechanism shall be so arranged that emergency manual charging and release of the spring is possible without electrical means. Hand crank shall be provided for each circuit breaker (*1 ea per each 3-pole CB*). ***It shall be properly stored inside the mechanism box. If it is impossible to store inside, an additional stable support shall be designed for the crank storage in such a way that to attach the crank to the mechanism box. The electrical charging of the spring shall be prevented when the hand crank is engaged. On the other hand, for safety purpose, the hand crank shall not be able to be engaged when the electrical charging of the spring is being operated.***

163-6.4 Disconnecter and Earthing Switch. The switches shall conform to the applicable requirements of IEC 62271-102 Standard. All switches shall be triple pole single break type. The ***disconnectors*** and ***earthing*** switches shall be operated with 125 V DC motor, suitable for remote operation and a manual emergency drive mechanism shall be provided ***with manual operating tool (hand crank) for 1 ea per each type for each compact switchgear.*** Electrical operation shall be prevented when the manual operator device is engaged. The mechanism shall open and close all three poles simultaneously. Each motor drive shall be self contained and equipped with auxiliary switches. Life lubrication of the bearings shall guarantee the maintenance free. The ***disconnectors*** and ***earthing*** switches

operation (both motor and manually operated) are possible only when the circuit breaker is opened.

All switches with electrical control for closing and opening operation shall be 2-pole controls. Operating motor shall be provided with thermal overload protection.

The mechanical position indicator shall be equipped with each disconnecting switch and earthing switch. The indicator shall be of white letter "I" on red background and white letter "O" on green background for closed and open position respectively. In case DS/ES combined mechanism type is chosen, combined position indicator is acceptable which shall be of white letter "I" on red background for DS closed position, white letter "O" on green background for DS/ES open position and white letter "E" on blue background for ES closed(earthed) position. The position indicator shall be located in such a way that visible from the far distance is possible with the mechanism housing closed

All switches must be equipped with mechanical position indicators ***in the quantity of one for each mechanism.*** These indicators shall be positively and solidly connected to the drive shaft. Linkages and levers shall be avoided.

All switches positions of each phase shall be either directly visible e.g. through dedicated glass windows or by direct mechanical indicators. The disconnecting and the earthing operations, in any case, shall be executed into the full respect of the GIS technology in accordance to the relevant IEC standard.

a. ***Disconnecter.*** The ***disconnecter*** shall be mechanical locking in both open and close position and pad locked. Interlocking against circuit breaker, ***earthing*** switches and other ***disconnecter*** shall be provided.

All auxiliary contacts including the spare ones shall be wired up to terminal block in the local control cubicle for indication, control and interlock connection. Eight (8) spare normally-open and eight (8) spare normally-closed contacts shall be provided.

b. ***Earthing Switch.*** All maintenance ***earthing*** switches for grounding the current carrying part of the equipment, shall be of ***electrical motor operated completed with emergency manual operated*** which shall be withstand the short-circuit fault currents in fully closed position. The used earthing switches shall be based on the IEC 62271-102. The outgoing earthing switches on overhead lines and cables must be suitable for switching capacitive and inductive currents.

The ***earthing*** switches shall be fully interlocked with the ***disconnecter*** to avoid closing of ***earthing*** switch on to energized conductor and to prevent circuit breakers or ***disconnecter*** from closing to energize grounded conductors.

163-6.5 Current Transformers.

- a. The current transformers shall be ring-type cores mounted on bushings. The cores shall be located in a metallic case and it shall be insulated using resin. Change of ratio (at secondary terminal blocks) shall be available, having multi-ratio in accordance with the Ratings and Features sheets.
- b. The current transformers shall be dimensioned for protection and/or measuring purposes. The module shall be able to accommodate current transformers in both sides.
- c. The position of each primary terminal in the current transformer SF₆ gas section shall be clearly marked by two plates permanently fitted to the metal-clad at each end of the current transformer section.
- d. The current transformers shall be in accordance with **IEC 61869-2**.
- e. The current transformers shall have an accuracy classification in accordance with the Ratings and Features sheets and shall have uniformly distributed secondary windings with five taps. The current transformer shall be for relaying service in accordance with **IEC 61869-2**.
- f. The secondary leads *of the current transformer* shall be stranded copper conductors, appropriately sized as the follows: **6 mm² for a secondary current 5 A and 4 mm² for a secondary current 1.**
- g. All five leads of each current transformer secondary shall be terminated on a separate short-circuiting type terminal block. The terminal blocks may be located in the local control cabinet or in a separate box in an easily accessible location.
- h. Current transformer nameplates shall be mounted on the equipment adjacent to the associated transformer, or at the terminal board where secondary leads are terminated and shall be in accordance with applicable requirements of **IEC 61869-2**.

163-6.6 Voltage Transformers

- a. The voltage transformers shall be gas insulated for use as a voltage source for **protective and measuring**. The transformers shall be designed as an integral part of the compact switchgear system.
- b. The voltage transformers shall be single phase and shall comply with the requirement of **IEC 61869-3**. Ratios and accuracy classes shall be as specified in Ratings and Features sheets.

- c. The secondary leads of the **voltage** transformers shall be brought out to a terminal box. All connections shall be made with solderless connectors. Cartridge type fuses or **Miniature Circuit Breaker (MCB)** for short circuit protection in the secondary circuits shall be furnished and installed in the terminal box. The fuses shall be non-renewable type and the interrupting rating shall be suitable for this installation.
- d. The transformers shall have a single primary and double secondary and may be either cascade or single core and coil type.
- e. The neutral end of the primary shall be insulated **and** brought out through a bushing rated not less than 3 kV.
- f. Compressed connection shall be securely made by applying copper ferrules compressed with a high pressure tool. The temperature rise of compressed connections shall be no greater than that of the associated conductor.
- g. Winding and core shall be contained in a metal tank.
- h. The windings shall be designed to eliminate, as far as practical, capacitive coupling between the primary and secondary.
- i. The transformer neutral bushing shall be adequately grounded to the enclosure by means of a removable copper strap.

163-6.7 Control Equipment.

- a. The compact switchgear shall be provided with control equipment mounted in cabinets on 2.5 mm thick panels installed at an appropriate height above the circuit breaker foundation and be accessible to maintenance personnel to perform the following function.
 - (a) Control, interlock, and indicate the position of switching devices in the switchgear.
 - (b) Monitor the density of the gas in the various gas sections.
 - (c) Monitor the drive mechanisms of the **disconnectors** and **earthing** switches.
 - (d) Provide a connection point to central control equipment such as protective relays, measuring instruments, remote control interfacing etc.
- b. The circuit breakers and their associated **disconnectors** and **earthing** switches shall be equipped with control cubicles. The cubicles shall be equipped with circuitry and auxiliaries to show, perform or control the following functions :

เอกสารไม่ควบคุม
 รับรองสำเนาโดย ทพอ.ร. กสส.ร. อวส.
 ก่อนนำไปใช้งาน
 ต้องตรวจสอบ .Revision ล่าสุด
 ฝ่ายวิศวกรรมระบบขนส่งกฟผ.

14 กุมภาพันธ์ 2568

- (a) A schematic diagram showing the equipment's single line diagram (HV part) and identifying labels of primary HV components shall be affixed inside the cubicle. The diagram shall be marked on aluminum engraved plate or equivalent.
- (b) Indicators for showing the position of all circuit breakers, *disconnectors* and *earthing* switches.
- (c) Control switches for operating the circuit breakers, *disconnectors* and *earthing* switches.
- (d) Means shall be provided in the control cubical to allow selection of Local, Remote or Maintenance. The "Local-Remote-Maintenance" switch shall be a lever control switch according to the functional control requirement as show on the "CB-CSA TYPICAL SCHEMATIC DIAGRAM" attached.

When "Local-Remote-Maintenance" switch is in the "Local" position, the circuit breakers and *disconnectors* and *earthing* switches shall be operated from control switch on the local control cabinet. In "Remote" position the circuit breakers and *disconnectors* shall be operated either from computer control system or control switch in the remote control room. In "Maintenance" position, the interlocking for the circuit breakers and *disconnectors* shall be by-passed and tripping signals from protection system shall be blocked.

- (e) Electrical interlocking between *circuit* breaker and the disconnector and earthing switch shall be always available.
- c. All cubicles shall be equipped with *automatic lighting (door switch)*, duplex *universal* socket-outlet and thermostatically controlled heating element for maintain the interior of the operating mechanism cabinet at a minimum temperature of 5°C above ambient. The circuit shall have a normally open, auxiliary contact to indicate AC fail to the heater.
- d. The control cubicles shall be weatherproof enclosure (IP55) in accordance to IEC 60529 including hinged doors for opening with provisions for holding doors in the open position. All doors shall be lockable.
- e. A removable plate for conduit entry shall be provided at the bottom of the control cabinet.
- f. The module shall be supplied with a unique control cubicle, fully pre-fabricated, pre-wired and pre-tested as unique interface between the multifunctional module and the control and protection system of the whole substation.

Sotraside Himmam

<p style="text-align: center;">เอกสารไม่ควบคุม</p> <p style="text-align: center;">รับรองสำเนาโดย พหจ-ร. กสส-ร. อวส.</p> <p style="text-align: center;">ก่อนนำไปใช้งาน Jan. 2025</p> <p style="text-align: center;">ต้องตรวจสอบ.Revision ล่าสุด</p> <p style="text-align: center;">ฝ่ายวิศวกรรมระบบส่ง กฟผ.</p>

163-6.8 Terminations

- a. All bushings shall be of approved manufacture and shall be capable of meeting the applicable requirements of IEC 60137 made by composite material (silicon rubber over a fiberglass core) or porcelain. The porcelain color shall be chocolate brown.
- b. The rating of all bushings shall meet or exceed the requirements of the Ratings and Features sheets.

c. Line Terminations

- (a) Termination of the overhead lines into the compact switchgear shall be conventional SF₆ to air bushings.
- (b) The puncture strength of all SF₆ to air bushings shall be greater than the dry flash over value.
- (c) For porcelain used in bushings shall be wet process, homogeneous, nonporous, and free from cavities or other flaws. The glazing shall be uniform in colour and free from blisters, burns, and other defects. The color of porcelain shall be chocolate brown.
- (d) For composite bushings, the tracking and erosion type test has to be passed according to IEC 61462 and IEC 62217.
- (e) The bushings shall be suitable for the use intended. The bushings may be either condenser type or non-condenser type but regardless of the type, they shall have proper voltage stress control.

d. Cable Terminations

- (a) Cable termination complete terminating kit including gas partition shall be designed to corresponding with the incoming and outgoing cable.
- (b) SF₆ metal enclosed cable end housing, the stress cone with suitable sealing to prevent oil or gas, if any, leak into the SF₆ gas compartment, the base armature fittings to fasten the enclosure and the top armature fittings to fix the connecting electrode shall be provided. The connection between the cable conductor and the tabular conductor of the compact switchgear shall be made with corona free electrode.
- (c) Interface between cable and termination shall be in accordance with standard IEC 60859.

163-6.9 Bus conductor, Insulators and Barriers

- a. The barrier-insulators shall be capable of withstanding for 5 min, pressures of three times maximum pressure differential to which they will be subjected in service, defined as vacuum on one side and usual operating pressure on the other side.
- b. Insulators shall be given thermal cycle design tests and shall demonstrate dielectric and mechanical integrity after thermal cycling.
- c. Bus conductors and the various connectors shall be of tubular copper or aluminum and have finger type plug-in connectors to assure uniform contact pressure. The movable and fixed contact surfaces of the connectors shall be silver plated or inlaid.
- d. The conductor surface shall be smoothly finished to prevent any electrical discharges. A homogeneous uniform electric field shall be maintained within the enclosure.
- e. The temperature rise of the compact switchgear conductor and equipment at ambient temperature shall not exceed the following values

(a) Bus conductor	60 °C
(b) Portions of bus which shall be silver Plated : Contactors, terminals and connections	60 °C
(c) External surfaces (Total temperature)	
1. Accessible	70 °C
2. Inaccessible	105 °C
3. Normally handled by an operator	50 °C

- f. All other conditions regarding temperature limitations are as noted in IEEE Std. C37.122.

163-6.10 Foundation, Support Structure and Grounding System. All equipment shall be furnished with base frame, anchor bolts, hardwares, supporting steel structures as required for complete installation.

All metal parts other than those forming part of any electrical circuit shall be grounded to the grounding system. Any necessary terminals on any part of the equipment required for this purpose shall be provided. Enclosures shall be multi-point earthed. The earthing philosophy and other countermeasures shall prevent unacceptable transient voltages from appearing across sections of the compact switchgear, control circuits and transformer to compact switchgear connections.

The compact switchgear steel structure shall be made of stainless steel AISI 304L or hot dip galvanized steel in accordance with ASTM A 123.

163-6.11 Cable and Other Necessary Materials. In order to minimize wiring and cabling at the site and consequently the risk of wrong electrical connections are preferred those modules having plug-in connectors from the local control cabinet to the drive mechanism of the circuit breaker and to the drive mechanism of the disconnecter and the earthing switch. Cable plugs and sockets shall be of protection level IP68. Control and auxiliary devices shall be segregated by grounded metallic partitions from the power supply circuit.

The wiring of auxiliary and control circuits shall also be segregated from the power supply circuit.

163-6.12 Terminal Block, Wire and Device Designations. Every point of terminal block and wire shall be assigned a designation, with identical designation on each corresponding terminal block and wire as one of following formats:

Format#1 (One-line pattern): The designation on each wiring end shall consist of both origin and destination designations which separated by '/' symbol. The origin designation shall always be indicated on the side adjacent to where the wiring is terminated while the far side shall always indicate the destination designation of the wiring. Depending on the arrangement of Terminal Block, Device and Wiring, Wire designation on both ends of the same wiring may be different.

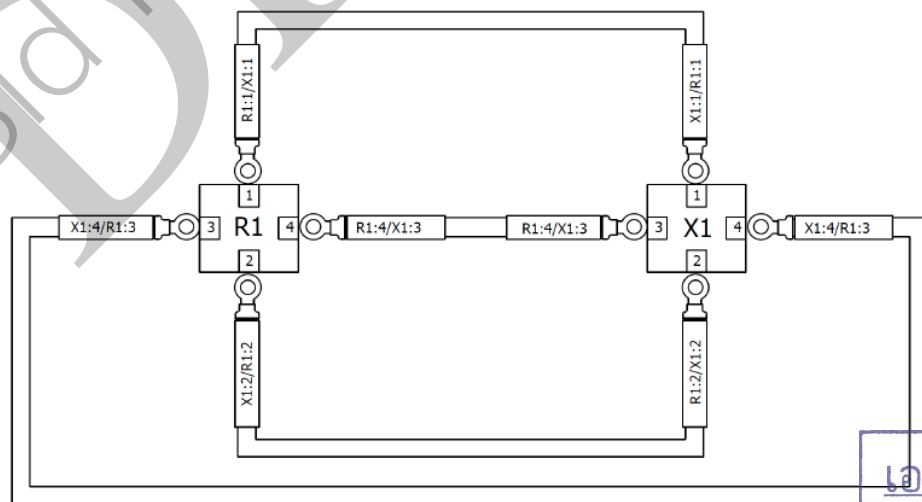

เอกสารไม่ควบคุม
 รับรองสำเนาโดย พทอ-ร. กสส-ร. อวส.
 ก่อนนำไปใช้งาน
 ต้องตรวจสอบ.Revision ล่าสุด
 ฝ่ายวิศวกรรมระบบส่ง กฟผ.

14 กุมภาพันธ์ 2568

Format#2 (Two-line pattern): The designation on each wiring end shall consist of both origin and destination designations. The origin designation shall be indicated on the first line while the second line shall indicate the destination designation of the wiring. Thus, Wire designation on both ends of the same wiring shall always be different (alternately between first line and second line). Most importantly, the first line and the second line shall be distinguished by appropriate solutions. For general wire marking sleeves with a full-circle design, the spacing below the first line to the second line shall be minimal and significantly less than the spacing below second line to first line; to make it clear which line is the first and which is the second.

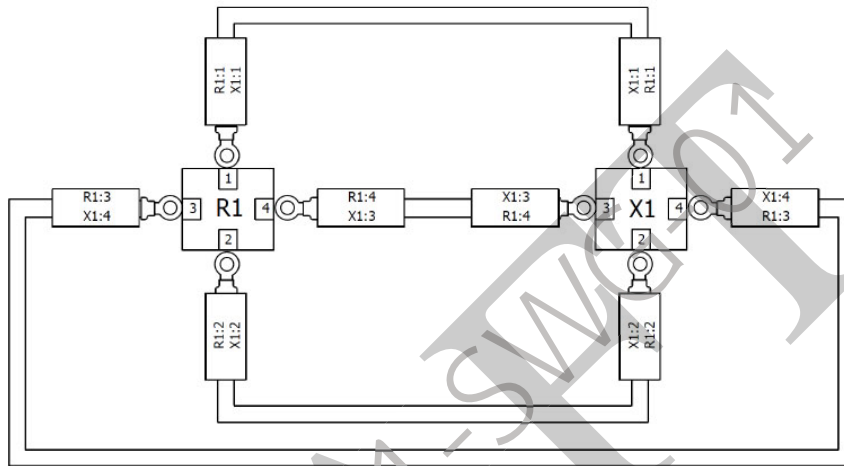

- The letters direction of wire mark shall be read from left to right (for horizontal wiring) and bottom to top (for vertical wiring)
- The terminal number of terminal block shall be arranged from top to bottom and left to right
- Only a single format shall be used. The use of both one-line and two-line formats is not permitted

This same designation shall also be indicated in the schematic and wiring diagrams. As a rule, a designation will not change until the wire is terminated or connected to other equipment. All wiring shall be designated at both ends by printing on wire designation sleeves. Wire designation shall be by permanent method unaffected by heat, solvents, or steam, and not easily dislodged. Each designation on the terminal blocks shall be machine-lettered, stamped, engraved or neatly marked with permanent ink on the removable marking strips provided for every terminal block. Approximately 20% of spare wire designation sleeve shall be furnished. Adhesive labels shall not be acceptable.

The terminal blocks for AC circuit and the terminal blocks for DC circuit shall be separately grouped as well as the AC terminal blocks shall be covered with transparent plastic box.

All wirings shall always be arranged inside the wire way.

เอกสารไม่ควบคุม
 รับรองสำเนาโดย นพอ.ร.กสจ.ร. อวส.
 ก่อนนำไปใช้งาน
 ต้องตรวจสอบ Revision ล่าสุด
 ฝ่ายวิศวกรรมระบบส่ง กฟผ.

163-6.13 Accessories. The following accessories shall be provided :

- a. **Terminal Pad.** Each equipment terminals for connecting to the line or other equipment shall be equipped with a suitable terminal pad unless otherwise specified. The terminal pad shall be provided with 14.3 mm (9/16 in) diameter holes with 45 mm (1 3/4 in) spacing between the centers of each hole in accordance with the NEMA Standards CC1.

The terminal pad shall be of high conductivity bronze, copper or aluminum alloy and shall be plated with hot flowed electro-silver or electro-tin to a thickness of not less than 0.0127 mm (0.0005 in). Whenever the larger terminal pads are required for higher current rating, the mounting holes shall conform to NEMA Standards CC1, and details of the mounting holes shall be submitted for approval.

- b. **Ground Terminal Connector.** The grounding terminal of the equipment shall be of the clamp type suitable for 4/0 AWG copper stranded conductor. Terminal connector shall be made of high conductivity material and shall be complete with corrosion resistance bolts, nuts and lock washers.
- c. **Overpressure Relief Device.** Each compartment shall be equipped with overpressure relief device to relieve abnormal pressure occurred in the event of an internal arcing fault, damage shall be confined to within the gas compartment where the fault occurred and the enclosure shall be prevented from rupturing, irrespective of the fault duration.
- d. **Position Indicator.** The mechanical position indicator shall be equipped with circuit breaker, *disconnect* and *earthing* switches. The indicator shall be of white letter "I" on red background and white letter "O" on green background for closed and open position respectively and shall be located in such a way that visible from the far distance is possible with the mechanism housing closed.

163-7 Cleaning, Painting and Corrosion Protection. All equipment, accessories, piping and wiring shall be provided with tropical finish to prevent corrosion and fungus growth.

Surface to be painted shall be cleaned to base metal and shall be thoroughly dry before application of any paint. After cleaning, the surface shall be given priming or sealing coat of paint. The primary coat shall be of the kind matching the finish paint mentioned above and shall have a rust preventive affect which followed by two coat of final paint.

The exposed portion of all equipment to be erected at the site shall be shop-coated with primary paint and finish paint. After the equipment has been installed at the site, the Contractor shall carry out touch up painting. Control cubicles and control boxes for auxiliary equipment, motors, pumps, tanks and other shop-finished products by manufacturer's standard shall be shop-finished with spray painting and shall not undergo painting at site.

Sotraside Himman

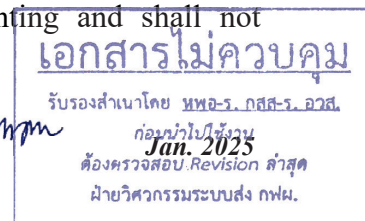

All ferrous material shall be hot dip galvanized. All other non ferrous parts shall be of seawater resistant material like aluminium alloy with copper content. Steel parts shall be zinc coated; aluminium cast parts can remain unpainted.

163-8 Nameplate. Nameplates shall be furnished and mounted at least the following :

163-8.1 Nameplate of Compact Switchgear. A nameplate of anodized aluminum with white lettering or stainless steel shall be attached in the front of compact switchgear to show the general information of compact switchgear at least the following :

- (a) Manufacturer/Country
- (b) Type *designation and serial number*
- (c) Year of manufacture
- (d) *Rated Voltage (U_r)*
- (e) *Rated continuous current (I_r)*
- (f) *Rated short-duration power-frequency withstand voltage (U_d)*
- (g) *Rated lightning impulse withstand voltage (U_p)*
- (h) *Rated short-time withstand current and duration time (I_k, t_k)*
- (i) *Rated peak withstand current (I_p)*
- (j) *Rated frequency (f_r)*
- (k) *Filling pressure for operation (p_m) including alarm pressure (p_{am}) and minimum functional pressure (p_{mm}), absolute pressure (abs.) or relative pressure (rel.) to be stated on the nameplate*
- (l) Circuit Breaker Compartment
 - 1) Manufacturer's name
 - 2) Manufacturer's type designation
 - 3) Manufacturer's serial number
 - 4) *Rated Voltage (U_r)*
 - 5) *Rated short-duration power frequency withstand voltage (U_d)*
 - 6) *Rated lightning impulse withstand voltage (U_p)*
 - 7) *Rated frequency (f_r)*
 - 8) *Rated continuous current (I_r)*

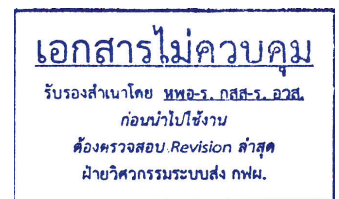

14 กุมภาพันธ์ 2568

9) **Rated short-circuit breaking current and duration time of short-circuit (I_{sc}, t_k)**

10) **Rated first pole-to-clear factor (k_{pp})**

11) **Rated operating sequence**

12) **Year of manufacture**

(m) **Circuit Breaker operating mechanism**

- 1) Manufacturer's name
- 2) Manufacturer's type designation
- 3) Manufacturer's serial number
- 4) Closing control voltage range
- 5) Tripping control voltage range
- 6) Closing current
- 7) Tripping current

(n) **Disconnect/earthing Switch**

- 1) Manufacturer's name
- 2) Manufacturer's type designation **and serial number**
- 3) Open / Close control voltage range
- 4) Open/ Close current
- 5) **Mechanical endurance class**
- 6) **Year of manufacture**
- 7) **Reference standard**

(o) **Disconnect/earthing Switch Operating mechanism**

- 1) **Manufacturer's name**
- 2) **Manufacturer's type designation and serial number**
- 3) **Mechanical endurance class**
- 4) **Year of manufacture**
- 5) **Reference standard**
- 6) **Serial number**

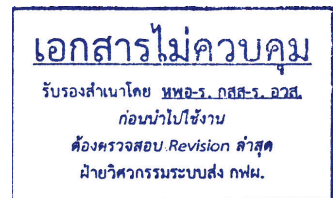

14 กุมภาพันธ์ 2568

(p) **EGAT contract number for compact switchgear**

(q) **Rated supply voltage of auxiliary and control circuits. Specify DC/AC (with rated frequency)**

(r) **Type and mass of gas for insulation**

- 163-8.2 Rating Plate of Equipment.** A nameplate of anodized aluminum or stainless steel shall be attached to each equipment in a conspicuous position near the equipment to show the necessary information of the equipment. *The nameplate for each individual device shall be conformed to its relevant IEC standard where ratings are not detailed on the common compact switchgear's nameplate.*
- 163-8.3 Switching Device Number Plate.** Switching device number of each equipment as specified on single line drawing shall be indicating on nameplate made of anodized aluminum or stainless steel or sticker.
- 163-8.4 EGAT Serial Number Plate.** EGAT serial number of each unit shall be indicated on the nameplate attached on the local control cubicle. If possible, it should be indicated close to the manufacturer serial number. The EGAT serial number will be advised after signing *the Letter of Award of contract (LOA).*
- 163-8.5 Phase Indicator Plate (A-B-C)** *The indicator plate shall be made by one of the following materials; stainless steel, anodized aluminum, sticker or paint. If the sticker or paint is chosen, the indicator shall be durable against surroundings and shall not be faded away after the time passed.*
- 163-9 Test.** Test of equipments shall be performed according to the requirements specified in each referred test item. The costs of all tests and reports shall be borne by the Contractor.
- 163-9.1 Type Test.** The proposed equipment shall already have the design test record of the same type and same rating as EGAT called for, in accordance with the tests specified in each equipment test items, which is subject to EGAT's approval (unless otherwise specified in each equipment test item). The *type* test record shall be required and submitted together with the tender document during the bidding.
- 163-9.2 Routine Test.** Each equipment shall be completely assembled at the factory and subject to the tests specified in each equipment test item.
- 163-9.3 Quality Conformance Test.** The quality conformance test shall be performed by selecting the sample from each lot of equipment. The numbers of samples for the test shall be as specified in the Standard.
- 163-9.4 Additional Test.** Additional test required as specified shall be performed on the one unit of equipment being supplied.
- 163-9.5 Test Report.** The report of all tests, curves and standard application data shall be furnished to EGAT immediately after the completion of the tests.

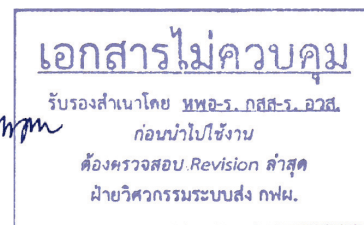

163-9.6 Test Procedure. The Contractor shall submit the test procedure of specified tests and actual design tests to EGAT for approval. The test procedure shall consist of procedures, applied voltage, current and criteria to justify the result of the tests.

163-9.7 Test Items for Compact Switchgear. The tests shall be performed in accordance with IEC 62271-205.

a. Type Tests. The tests shall be performed in accordance with Clause 7 of IEC 62271-1. The purpose of design tests is to verify the design characteristics of the compact switchgear, the *type* tests shall be carried out on a complete single-phase or three-phase assembly of one typical switchgear unit. Because of the variety of types, ratings and possible combinations of components, the performance of any particular arrangement may be substantiated by test data of comparable arrangements. The following tests shall be made **for compact switchgear assembly in its entirety**:

- (a) Dielectric tests
- (b) Radio interference voltage (*apply only to switchgear having $U_r \geq 245$ kV*)
- (c) *Measurement of the resistance of the main circuits*
- (d) Temperature rise test
- (e) Short-time withstand and peak withstand current tests
- (f) *Mechanical and environmental tests*

b. Routine Test. The tests shall be performed in accordance with Clause 8 of IEC 62271-1. The purpose of these tests is to detect possible material or manufacturing defects. The tests shall be made on all transportable assemblies and at the manufacturer's works. The following tests shall be made on each *device of the compact switchgear* assembly :

- (a) Dielectric test on the main circuit
- (b) Tests on auxiliary and control circuits
- (c) Functional tests on auxiliary and control circuits
- (d) *Measurement of the resistance of the main circuit*
- (e) Mechanical operation test
- (f) *Tightness test*
- (g) *Design and visual checks*

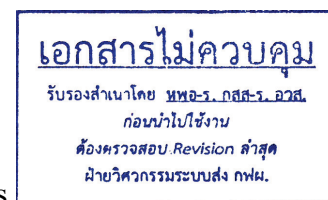

14 กุมภาพันธ์ 2568

- (h) Timing tests, for test motion, the test point shall be specified in the test report

163-9.8 Test Items for Power Circuit Breaker. The tests shall be performed in accordance with IEC 62271-100 or approved equivalent Standards, unless otherwise specified.

a. Type Tests

- (a) Dielectric test
- (b) *Continuous current tests*
- (c) *Resistance measurement*
- (d) Short-time withstand current and peak withstand current tests
- (e) *Additional tests on auxiliary and control circuits*
- (f) *Mechanical operation test at ambient temperature*
- (g) *Terminal fault tests*
- (h) *Radio interference voltage(RIV) tests ($U_r \geq 245$ kV)*
- (i) *Short-line fault tests*
- (j) *Out-of-phase making and breaking test (If this application is assigned in Ratings and Features (RF) document)*
- (k) *Capacitive current switching test (If this application is assigned in Ratings and Features (RF) document)*

163-9.9 Test Items for Disconnectors and Earthing Switches. The tests shall be performed in accordance with IEC 62271-102 or approved equivalent Standards, unless otherwise specified.

a. Type Tests

- (a) Dielectric test
- (b) *Continuous current test*
- (c) Measurement of the resistance of the main circuit
- (d) Short time and peak withstand current test
- (e) Test to prove the short-circuit making performance of earthing switches
- (f) *Mechanical* endurance test

เอกสารไม่ควบคุม
รับรองสำเนาโดย พพร-กสศ-ร.อวส.
ก่อนนำไปใช้งาน
ต้องตรวจสอบ.Revision สำสุด
ฝ่ายวิศวกรรมระบบส่ง กฟผ.

14 กุมภาพันธ์ 2568

163-9.10 Test Items for Voltage Transformer. The tests shall be performed in accordance with the latest *IEC 61869-3* or approved equivalent Standards, unless otherwise specified.

a. Type Tests

- (a) *Impulse voltage test on primary terminals*
- (b) *Short-circuit withstand capability test*
- (c) *Temperature rise test*
- (d) *Test for accuracy*
- (e) *Electromagnetic Compatibility tests (EMC)*
- (f) *Enclosure tightness test at ambient temperature*
- (g) *Pressure test for the enclosure*

Note: For Voltage Transformer which both Protective and Measuring classes are assigned on the same winding;

- If the type test of both specified or better classes have already been performed on the same winding, the type test report(s) shall be submitted with the tender documents during bidding stage.

- If not, the type test report(s) for each specified or better class on separated windings shall instead be submitted with the tender documents during bidding stage, along with manufacturer's letter to confirm the capability of manufacturing both classes on the same winding.

b. Routine Tests

- (a) *Power-frequency voltage withstand tests on primary terminals*
- (b) *Power-frequency voltage withstand tests on secondary terminals*
- (c) *Test for accuracy*
- (d) *Verification of markings*
- (e) *Winding resistance measurement for each ratio of all windings*
- (f) *Partial discharge measurement. The permissible partial discharge level shall not be more than 10 pC at U_m and 5 pC at $1.2 U_m/\sqrt{3}$ (U_m : Maximum Service Voltage)*
- (g) *Enclosure tightness test at ambient temperature*
- (h) *Pressure test for the enclosure*

Sotraside Himmam

<p>เอกสารไม่ควบคุม</p> <p>รับรองสำเนาโดย พหจ-ร. กสส-ร. อวส.</p> <p>ก่อนนำไปใช้งาน</p> <p>Jan. 2025</p> <p>ต้องตรวจสอบ: Revision ล่าสุด</p> <p>ฝ่ายวิศวกรรมระบบส่ง กฟผ.</p>

163-9.11 Test Items for Current Transformer. The tests shall be performed in accordance with the latest *IEC 61869-2*.

a. Type Tests

- (a) *Short-time current tests*
- (b) *Test for accuracy*
- (c) Temperature rise test at maximum rated current (of continuous thermal current rating factor)
- (d) *Electromagnetic Compatibility tests*
- (e) *Impulse voltage withstand test on primary terminals*
- (f) *Enclosure tightness test at ambient temperature*
- (g) *Pressure test for the enclosure*
- (h) *Verification of the degree of protection by enclosure*

b. Routine Tests

- (a) *Power-frequency voltage withstand tests on primary terminals*
- (b) *Power-frequency voltage withstand tests on secondary terminals*
- (c) *Test for accuracy*
- (d) *Determination of the secondary winding resistance*
- (e) *Test for rated knee point e.m.f. (E_k) and exciting current at E_k*
- (f) *Inter-turn overvoltage test*

163-9.12 Test Items for Terminations. The tests shall be performed in accordance with IEC 60137.

a. Type Tests. One unit of bushing of each type shall be performed to fully demonstrate the ratings required by this specification. The bidder shall furnish with his bid the tests he proposes as evidence of design adequacy, both electrical and mechanical.

- (a) Wet power-frequency voltage withstand test
- (b) Dry lightning impulse voltage withstand test
- (c) Temperature rise test

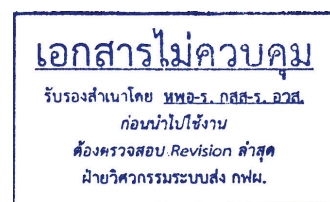

14 กุมภาพันธ์ 2568

- (d) Verification of thermal short-time current withstands
- (e) Cantilever load withstand test
- (f) Internal pressure test
- (g) External pressure test
- (h) Verification of dimensions

163-9.13 Test and Verification after Erection

After erection, the equipment shall be tested to check its correct operating, possible defects resulting from incorrect erection and/or assembly, damage to components or the presence of a foreign body in the switchgear, which could give rise to a fault during operation.

163-10 Spare Parts

All spare parts subject to damage or deterioration by moisture shall be packed in moisture-proof material. All spare parts shall be of the same materials and workmanship as the corresponding original parts and shall be interchangeable therewith. The Bidder shall include in his bid a list of recommended spare parts, together with unit prices effective for a period of two years from the date of contract award.

163-11 Appliances & Tools

The Contractor shall furnish all special appliances and tools including alignment templates that the equipment manufacturer deems necessary for satisfactory installation, operation, testing and maintenance of the equipment, including assembly and disassembly. Special tools and appliances shall be construed as those not readily available from appliance and tool suppliers in Thailand and those the equipment manufacturer has procured or fabricated for use with this or similar equipment. The Contractor shall submit to EGAT for approval a list of all appliances and tools required for the above stated purposes to furnish.

All required SF₆ gas, hydraulic fluid and oil, as applicable, including that needed to replace quantities lost as a result of leakage or waste during field assembly and testing, shall be furnished by the Contractor. The Contractor shall also furnish excess SF₆ gas, hydraulic fluid and oil in a quantity equivalent to 15% of the total equipment actual requirements. Gas required for field filling and excess gas shall be supplied in non-returnable American Standard Compressed Gas cylinders. The SF₆ gas shall not contain oil or other contaminants. Hydraulic fluid and oil shall be furnished in non-returnable steel drums.

The Contractor shall furnish a hose(s), as required, complete with necessary fittings for transferring SF₆ gas from the gas cylinders to the compact switchgear equipment.

Sotraside Himmam

<p>เอกสารไม่ควบคุม</p> <p>รับรองสำเนาโดย พหจ-ร. กสศ-ร. อวส.</p> <p>ก่อนนำไปใช้งาน</p> <p>Jan. 2025</p> <p>ต้องตรวจสอบ: Revision ล่าสุด</p> <p>ฝ่ายวิศวกรรมระบบส่ง กฟผ.</p>

163-12 Data, Description Materials and Drawings

The following drawings and information materials shall be furnished with the proposal data.

- General arrangement drawings of the compact switchgear with different sections and module showing constructional features and disposition of various equipment.
- Technical leaflets on major equipment as stipulated in Sub-clause 163-6.1 of this specification.
- Type test data and certificate.

Bid No. BBS7-SMG01

Sokrasi Himmam

เอกสารไม่ควบคุม

รับรองสำเนาโดย ทพอ-ร. กสส-ร. อวส.

ก่อนนำไปใช้งาน

ต้องตรวจสอบ.Revision ล่าสุด

ฝ่ายวิศวกรรมระบบส่ง กฟผ.

14 กุมภาพันธ์ 2568

163-13 Drawings and Documents

Drawings and documents shall at least comprise of the followings :

Item	Drawings Title	Approval and Final Dwgs	CD-ROM
1	Drawing list of all drawings submitted for approval (<i>use Drawing and Document Status Report form (DDSR) as the part of attached document when submit the drawings for EGAT approval</i>)	x	-
2	General arrangement drawing, outline dimension drawings of the equipment showing general arrangement and location of fittings	x	-
3	Foundation and anchor bolt details including dead load and impact load with direction	x	-
4	Electrical schematic and wiring diagram	x	x
5	Interlocking logic diagram	x	x
6	Outline, schematic diagram and wiring diagram for drive mechanism of various equipment	x	x
7	Local control cubicle outline including component layout completed with legend and mimic diagram	x	-
8	Assembly drawing for erection at site with part numbers and schedule of materials	x	-
9	Any other relevant drawings and data necessary for erection, operation and maintenance	x	-
10	Transport/shipping dimensions and weights	x	-
11	Rating plate drawings of each equipment/device	x	-

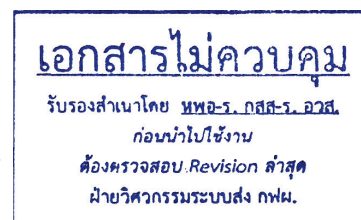

163-14 Instruction Manual for Compact Switchgear. Instruction manual shall consist of all necessary information and shall comprise of at least the following parts.

Part A : Compact Switchgear instruction including installation, operation and maintenance manuals.

a. compact switchgear general technical information

b. Installation instruction including but not limited to

- Flow chart for installation
- Installation instruction
- SF₆ gas filling

c. Maintenance and Operation instruction

- Routine inspection
- Maintenance
- Operation guide
- Assembly and disassembly instructions complete with component parts list including ordering part numbers, designation of part No. and part identification drawing.

Part B : Instructions and manual catalog including installation and maintenance manual of all accessories.

Part C : Complete set of all final drawings and/or documents arranged in order of each complete item.

Sotavadi Hirinon

เอกสารไม่ควบคุม

รับรองสำเนาโดย ทพอ-ร. กสส-ร. อวส.

ก่อนนำไปใช้งาน

ต้องตรวจสอบ Revision สำสุด

ฝ่ายวิศวกรรมระบบส่ง กฟผ.

14 กุมภาพันธ์ 2568

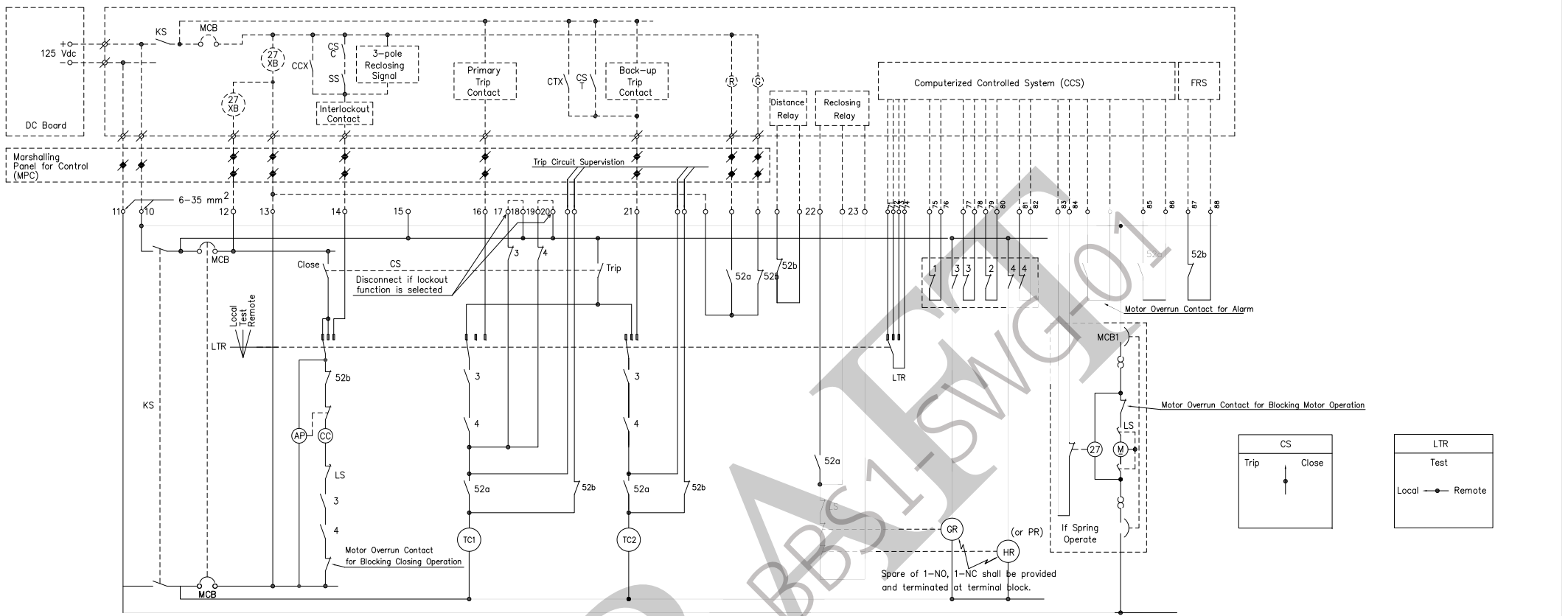

LOCKOUT (CLOSE CIRCUIT) CONTACT

- Low hydraulic pressure (stage 2) or Low pneumatic pressure (stage 2)
- Low SF6 gas density (stage 2)

LOCKOUT (TRIP CIRCUIT) OR TRIP CONTACT

- Low hydraulic pressure (stage 2) or Low pneumatic pressure (stage 2)
- Low SF6 gas density (stage 2)

CONTACT OF DENSIMETER OR PRESSURE RELAY

- Low SF6 gas density (stage 1)
- Low SF6 gas density (stage 2)
- Low hydraulic pressure (stage1)
- Low pneumatic pressure (stage1) or - Low hydraulic pressure (stage2)
- Low pneumatic pressure (stage2) or

LOW SF6 GAS DENSITY, LOW HYDRAULIC OR PNEUMATIC PRESSURE

- Stage 1 = Alarm
 - Gas density (1) = _____ at _____ °C
 - H (or P) Pressure (2) = _____ at 40 °C
- Stage 2 = Lock (close) and lock (trip) or trip
 - Gas density (3) = _____ at _____ °C
 - H (or P) Pressure (4) = _____ at 40 °C

LOCKOUT AT CB IN CLOSE POSITION

Suitable means shall be provided to keep circuit breaker at close position, automatic self opening of circuit breaker at further lower pressure is not accepted.

DEVICE	DESCRIPTION	RATING	TYPE	MANUFACTURER
CS	Trip/Close Control Switch			
LTR	Local/Test/Remote Selector Switch			
CC	Closing coil	9 - 14V Vdc	A	S
TC1	Primary Tripping coil	10-140 Vdc	A	mS
TC2	Back-up tripping coil	Vdc	A	mS
AP	Antipumping relay	Vdc	A	mS
GR	Gas density auxiliary relay		A	
HR (or PR)	Hydraulic (or Pneumatic) pressure auxiliary relay		A	
M	Motor	V	A	HP
P (or C)	Pump (or Compressor)	V	A	HP
27	DC under voltage alarm relay, Slow drop out	125 Vdc		
KS	Knife switch	V	A	
MCB	Molded case circuit breaker with thermal trip, 2-pole	V	KA	AT AF
MCB1	Molded case circuit breaker with thermal trip, 2-pole	V	KA	AT AF
MCB2	Molded case circuit breaker with thermal trip, 3-pole	V	KA	AT AF
MCB3	Molded case circuit breaker with thermal and instantaneous trip, 1-pole	V	A	AT AF
TS	Thermostat	Range		°C
SH	Space heater	V	A	W
TB	Terminal block	600 V	A	
LS	Limit switch for spring charge motor	V	A	
1	Gas density switch (stage 1)	V	A	
2	Pressure switch (P or H) (stage 1)	V	A	
3	Gas density switch (stage 2)	V	A	
4	Pressure switch (P or H) (stage 2)	V	A	

Hydraulic (or Pneumatic)

Pressure and Operating Time

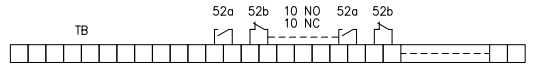
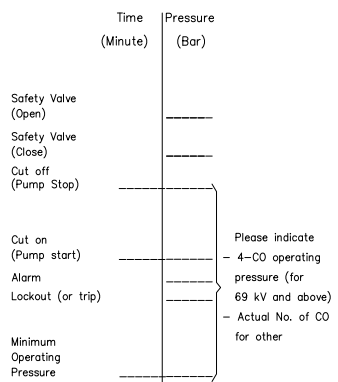

Terminal block diagram including spare (10 % but not less than 10 terminals)

The Schematic Status

- CB at open position
- Gas at low density (stage 2)
- Hydraulic or Pneumatic at low pressure (stage 2)
- Voltage at under voltage
- Mechanism closing springs charged

Note

This schematic diagram is intended to show functional control requirement only, actual schematic diagram corresponding to this requirement shall be designed by manufacturer.

เอกสารไม่ควบคุม
 รับรองสำเนาโดย พหุธร อดิศร-อดุลย์
 ก่อนนำไปใช้งาน
 ต้องตรวจสอบ Revision ล่าสุด
 ฝ่ายวิศวกรรมระบบส่ง กฟผ.

14 กุมภาพันธ์ 2568

SUBSTATION ELECTRICAL EQUIPMENT ENGINEERING DEPARTMENT	
THREE POLE OPERATED CIRCUIT BREAKER	
TYPICAL SCHEMATIC DIAGRAM	
Date : 01/2025	Dwg. No. : TP-E-CB-CSA 6.1
SH. 01/02	Rev. 6

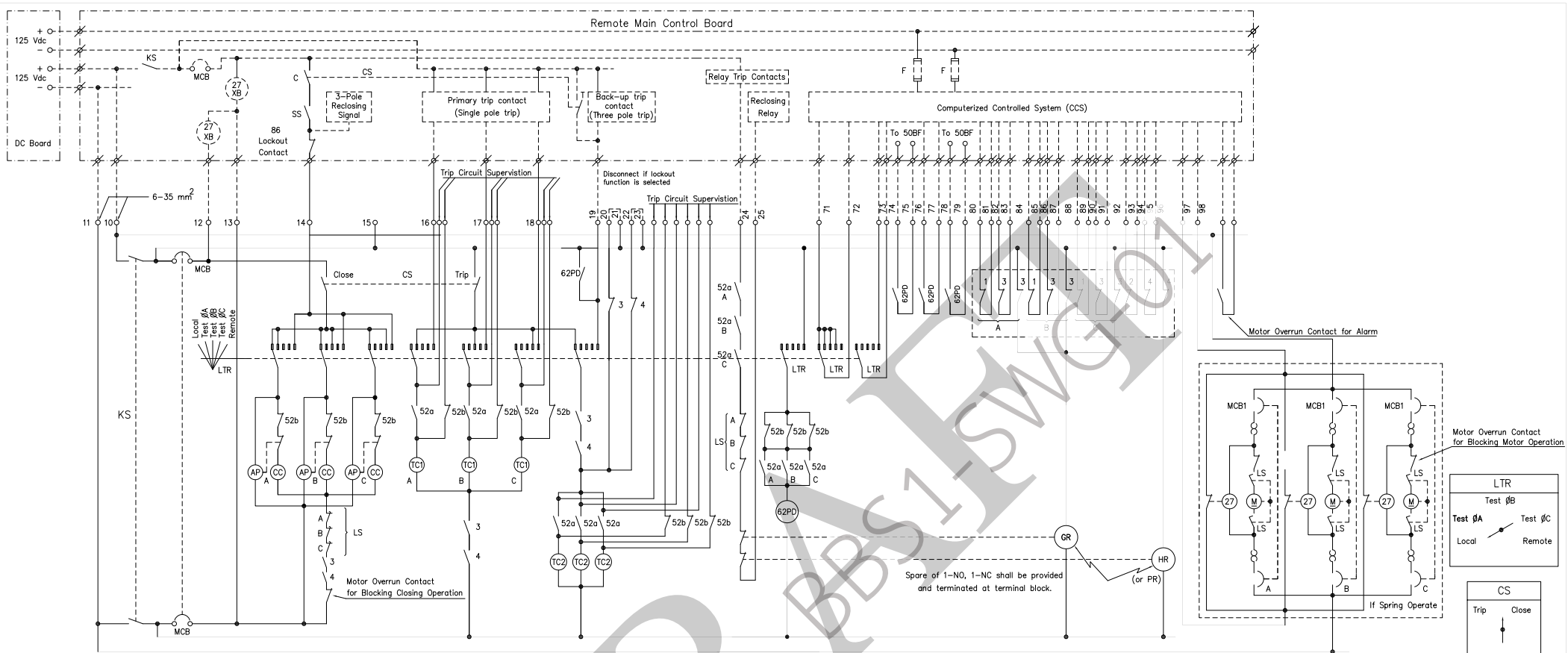

LOCKOUT (CLOSE CIRCUIT) CONTACT

- Low hydraulic pressure (stage 2) or Low pneumatic pressure (stage 2)
- Low SF6 gas density (stage 2)

LOCKOUT (TRIP CIRCUIT) OR TRIP CONTACT

- Low hydraulic pressure (stage 2) or Low pneumatic pressure (stage 2)
- Low SF6 gas density (stage 2)

CONTACT OF DENSMETER OR PRESSURE RELAY

- Low SF6 gas density (stage 1)
- Low SF6 gas density (stage 2)
- Low hydraulic pressure (stage 1) or Low pneumatic pressure (stage 1)
- Low hydraulic pressure (stage 2) or Low pneumatic pressure (stage 2)

LOW SF6 GAS DENSITY/LOW HYDRAULIC OR PNEUMATIC PRESSURE

- Stage 1 = Alarm
 - Gas density (1) = _____
 - H (or P) pressure (2) = _____ at _____ °C
 - _____ at 40 °C
- Stage 2 = Lock (close) and Lock (trip) or trip
 - Gas density (3) = _____
 - H (or P) pressure (4) = _____ at _____ °C
 - _____ at 40 °C

LOCKOUT AT CB IN CLOSE POSITION

Suitable means shall be provided to keep circuit breaker at close position, automatic self opening of circuit breaker at further lower pressure is not accepted.

DEVICE	DESCRIPTION	RATING	TYPE	MANUFACTURER
CS	Trip/Close Control Switch	_____ V _____ A		
LTR	Local/Test/Remote Selector Switch	_____ V _____ A		
CC	Closing coil	90-140 Vdc, _____ A, _____ MS		
TC1	Primary tripping coil	70-140 Vdc, _____ A, _____ MS		
TC2	Back-up tripping coil	70-140 Vdc, _____ A, _____ MS		
AP	Antipumping relay	_____ Vdc, _____ A, _____ MS		
62PD	Pole disagreement relay	50-1000 Vdc, _____ A, _____ MS		
GR	Gas density auxiliary relay	_____ V _____ A		
HR (or PR)	Hydraulic (or Pneumatic) pressure auxiliary relay	_____ V _____ A		
M	Motor	_____ V _____ A _____ HP		
P (or C)	Pump (or Compressor)	_____ V _____ A _____ HP		
27	DC under voltage alarm relay, slow drop out	120 Vdc		
KS	Knife switch	_____ V _____ A		
MCB	Molded case circuit breaker with thermal trip, 2-pole	_____ V _____ KA	AT, AF	
MCB1	Molded case circuit breaker with thermal trip, 2-pole	_____ V _____ KA	AT, AF	
MCB2	Molded case circuit breaker with thermal trip, 3-pole	_____ V _____ KA	AT, AF	
MCB3	Molded case circuit breaker with thermal and instantaneous trip, 1-pole	_____ V _____ A	AT, AF	
TS	Thermostat	Range _____ °C		
SH	Space heater	_____ V _____ A _____ W		
TB	Terminal block	600 V _____ A		
LS	Limit switch for spring charge motor	_____ V _____ A		
1	Gas density switch (stage 1)	_____ V _____ A		
2	Pressure switch (P or H) (stage 1)	_____ V _____ A		
3	Gas density switch (stage 2)	_____ V _____ A		
4	Pressure switch (P or H) (stage 2)	_____ V _____ A		

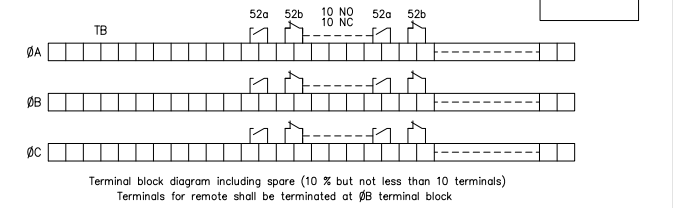
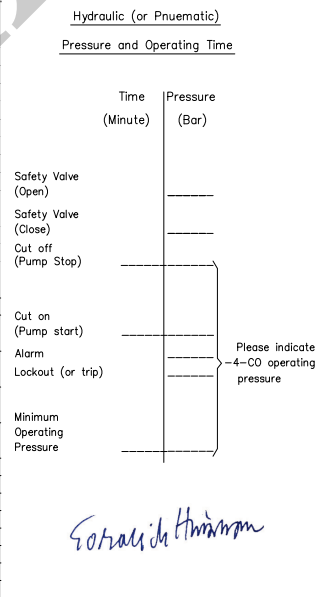

Close Command

- Remote = 3Ø
- Local = 3Ø
- Test 0A } 1Ø
- Test 0B } 1Ø
- Test 0C } 1Ø

Trip Command

- Remote = 1Ø (primary tripping coil)
- Local = 3Ø (back-up tripping coil)
- Test 0A } 1Ø (primary tripping coil)
- Test 0B } 1Ø (primary tripping coil)
- Test 0C } 1Ø (primary tripping coil)

The Schematic Status

- CB at open position
- Gas at low density (stage 2)
- Hydraulic or Pneumatic at low pressure (stage 2)
- Voltage at under voltage

Note

This schematic diagram is intended to show functional control requirement only, actual schematic diagram corresponding to this functional requirement shall be designed by manufacturer.

เอกสารไม่ควบคุม
รับรองสำเนาโดย พหอร. กสตร. อตส.
ก่อนนำไปใช้งาน
ต้องตรวจสอบ Revision คำสั่ง
ฝ่ายวิศวกรรมระบบส่ง กฟน.
14 กุมภาพันธ์ 2568

SUBSTATION ELECTRICAL EQUIPMENT ENGINEERING DEPARTMENT			
SINGLE POLE & THREE POLE OPERATED CB-CSA			
TYPICAL SCHEMATIC DIAGRAM			
Date : 01/2025	Dwg. No. : TP-E-CB-CSA 6.2	SH.	Rev.
		02/02	0

Drawing and Document Status Report

Contract No.
 Item No.
 Job No.
 Substation

Name of Company
 Date

No.	Drawing Document No.	Sheet		Description	Submit/Return	1st Submission			2nd Submission			3rd Submission			Latest Submission			Completion Date for DWG		Number of Submissions	Remarks	
		No.	Rev.			Ref.	Date	St./Act.	Ref.	Date	St./Act.	Ref.	Date	St./Act.	Ref.	Date	St./Act.					
					Submit	PLAN													PLAN			
					Return	ACTUAL													ACTUAL			
					Submit	PLAN													PLAN			
					Return	ACTUAL													ACTUAL			

Notes: Ref. = Referenced Letter No., St. = Status, Act. = Action
 Status/Action: AD = Drawings/Documents for Approval , R-DWG = Drawings/Documents for Re-approval, FD = Final Drawings for Approval, RD = Reproducible Drawings for Approval,
 CD = CD-ROM for Approval, A = Approved, AN = Approved except as Noted , AF = Approved and Regarded as Final Drawings/Documents, FC = For Construction,
 NR = Not Reviewed, RC = Returned for Correction, ACPT = Accepted, ACK = Acknowledged

เอกสารไม่ควบคุม
 รับรองสำเนาโดย พท.ร. กสสร. อวส.
 ก่อนนำไปใช้งาน
 ต้องตรวจสอบ .Revision ล่าสุด
 ฝ่ายวิศวกรรมระบบส่ง กฟผ.

Sotraside Himmam

14 กุมภาพันธ์ 2568

DRAFT

**SECTION J
DRAWINGS**

J. DRAWINGS

J-1. Drawings

The following drawings are attached hereto and made a part of the Contract Documents:

No.	Description	Dwg. No.	Sheet	Rev.
01	SINGLE LINE DIAGRAM	BB2-S-1	01/02	0
02	SINGLE LINE DIAGRAM	BB2-S-1	02/02	-

DRAFT

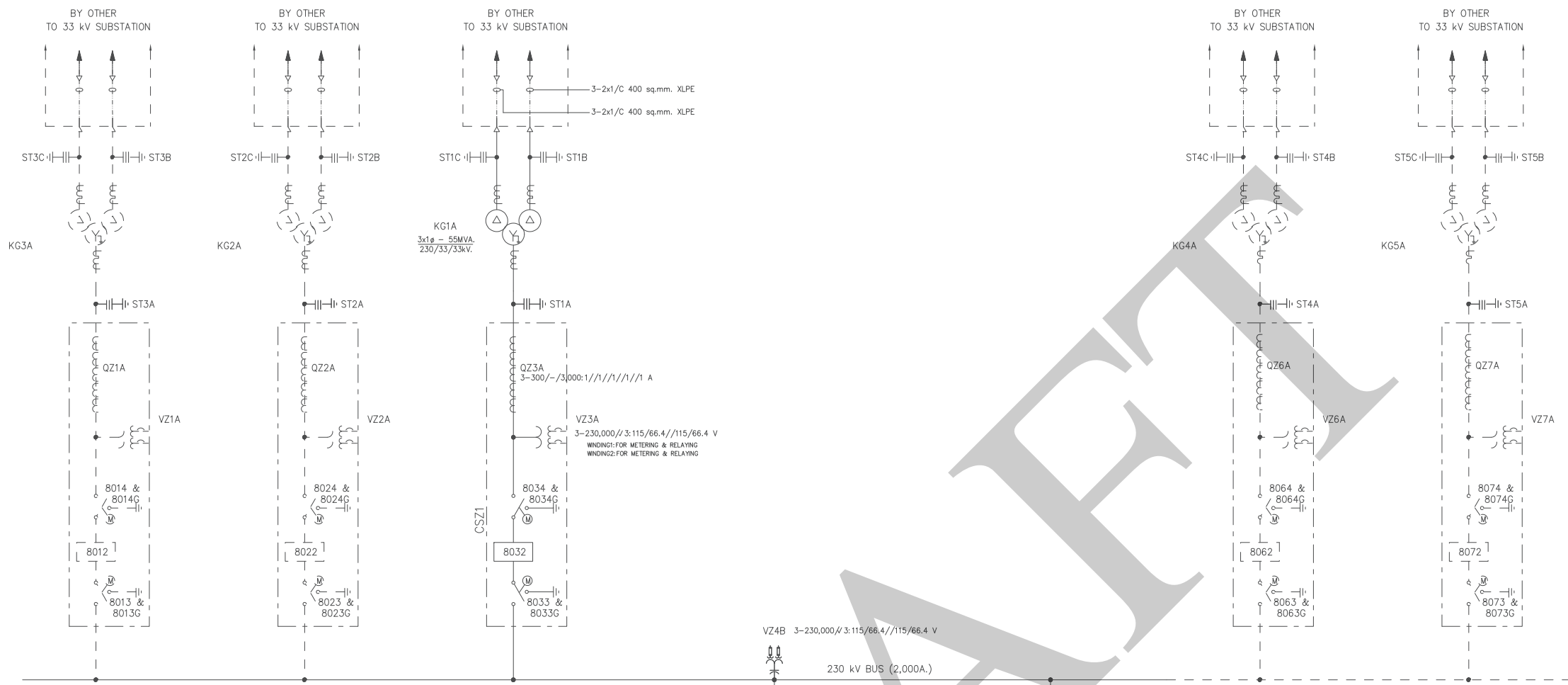

NOTES

- The Compact switchgears may be designed the location of disconnecting switch combined with earthing switch(80X4&80X4G), current transformers(QZXA) and voltage transformers(VZXA) different from this drawing.
- The total number of CT's cores and VT's windings shall be equal to as shown in this drawing.

ได้ตรวจสอบแล้ว
 ลงชื่อ.....
 (นายวุฒิชัย รุ่งแจ้ง)
 วันที่..... 30 Jan 2025
 กองวิศวกรรมสถานีไฟฟ้าแรงสูง

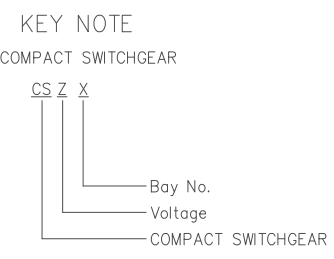

DRAWING LIST

BHUMBOL 2 SUBSTATION

SINGLE LINE DIAGRAM.....	DWG.NO.BB2-S-1-01/02
SINGLE LINE DIAGRAM.....	DWG.NO.BB2-S-1-02/02
GENERAL ARRANGEMENT PLAN.....	DWG.NO.BB2-S-2-01/01
BUS STRUCTURE PLAN.....	DWG.NO.BB2-S-3-01/01
BUS STRUCTURE SECTIONS.....	DWG.NO.BB2-S-4-01/01
SUBSTATION GROUNDING SYSTEM.....	DWG.NO.BB2-S-5-01/01
CONTROL BUILDING EQUIPMENT LAY-OUT.....	DWG.NO.BB2-S-6-01/01
SUBSTATION STRUCTURE LAY-OUT.....	DWG.NO.BB2-S-7-01/02
230 kV TAKE OFF STEEL STRUCTURE.....	DWG.NO.BB2-S-7-02/02

LEGEND

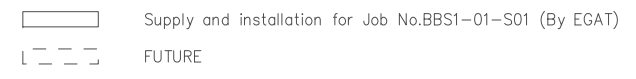

ELECTRICITY GENERATING AUTHORITY OF THAILAND

THITWAT	RECOMMENDED AND VALIDATED	DRAWING NAME	BHUMBOL 2 SUBSTATION
DESIGNED	CONCURRED	DESCRIPTION OF DETAIL DRAWING	SINGLE LINE DIAGRAM
VERIFIED	ASSISTANT DIRECTOR, TRANSMISSION SYSTEM ENGINEERING DIVISION-2	JOB No.	BBS1-01-S01
APPROVED	DATE	REPLACING DWG.No.	BB2-S-1
DIRECTOR, TRANSMISSION SYSTEM ENGINEERING DIVISION		DWG.No.	BB2-S-1

0	BBS1-01-S01	NEW 230 kV AIS SUBSTATION	-	-	-	-	-	-	-	-	-
REV.No.	JOB No.	JOB DESCRIPTION	DRAWN	DESIGNED	VERIFIED	VALIDATED	RECOMMENDED	CONCURRED	APPROVED	DATE	

		EQUIPMENT	DESIGNATION	RATING	QTY.	BID NO.	REMARK
ADDITIONAL EQUIPMENT FOR JOB.No.BBS1-01-S01							
COMPACT SWITCHGEAR	CSZ1	POWER & DIST. TRANSFORMER	KG1A (With Lightning Arrester)	230-33/33 kV,1ø-55 MVA	3	-	SUPPLY BY EGAT
		INSTRUMENT TRANSFORMERS	QZ4B,QZ5B	230 kV 1,000x2,000:1//1 A, 50 kA	6	-	-
			VZ4B	230,000/3:115/66.4//115/66.4 V	3	-	-
		DISCONNECTING SWITCHES	8045&8045G,8055&8055G	230 kV 3,150 A. MOTOR OPERATE (WITH MANUAL GROUND BLADE)	2	-	-
		POWER CIRCUIT BREAKERS	8032	230 kV 3,150 A., Isc = 50 kA, Ip = 125 kA (Peak factor = 2.50)	1	-	-
		DISCONNECTING SWITCHES	8033&8033G,8034&8034G	230 kV 3,150 A.	2	-	-
	CSZ2	INSTRUMENT TRANSFORMERS	QZ3A	230 kV 300/-/3,000:1//1//1//1//1 A, 50 kA RELAYING CLASS SP20, 5 VA	3	-	-
			VZ3A (3-PHASE)(WO/C)	230,000/3:115/66.4//115/66.4 V WINDING No.1:RELAYING&METERING CLASS 0.2&3P,1 VA WINDING No.2:RELAYING&METERING CLASS 0.2&3P,1 VA SIMULTANEOUS BURDEN 1 VA	3	-	-
		POWER CIRCUIT BREAKERS	8042	230 kV 3,150 A., Isc = 50 kA, Ip = 125 kA (Peak factor = 2.50)	1	-	-
		DISCONNECTING SWITCHES	8043&8043G,8044&8044G	230 kV 3,150 A.	2	-	-
		INSTRUMENT TRANSFORMERS	QZ4A	230 kV 300/-/3,000:1//1//1//1//1 A, 50 kA RELAYING CLASS SP20, 5 VA	3	-	-
			VZ4A (3-PHASE)(WO/C)	230,000/3:115/66.4//115/66.4 V WINDING No.1:RELAYING&METERING CLASS 0.2&3P,1 VA WINDING No.2:RELAYING&METERING CLASS 0.2&3P,1 VA SIMULTANEOUS BURDEN 1 VA	3	-	-
	CSZ3	POWER CIRCUIT BREAKERS	8052	230 kV 3,150 A., Isc = 50 kA, Ip = 125 kA (Peak factor = 2.50)	1	-	-
		DISCONNECTING SWITCHES	8053&8053G,8054&8054G	230 kV 3,150 A.	2	-	-
		INSTRUMENT TRANSFORMERS	QZ5A	230 kV 300/-/3,000:1//1//1//1//1 A, 50 kA RELAYING CLASS SP20, 5 VA	3	-	-
			VZ5A (3-PHASE)(WO/C)	230,000/3:115/66.4//115/66.4 V WINDING No.1:RELAYING&METERING CLASS 0.2&3P,1 VA WINDING No.2:RELAYING&METERING CLASS 0.2&3P,1 VA SIMULTANEOUS BURDEN 1 VA	3	-	-

ได้ตรวจสอบแล้ว
 ลงชื่อ.....*กมลพงษ์ วัฒนา*.....
 (นายวุฒิชัย รุ่งแจ้ง)
 วันที่.....**19 Dec 2024**.....
 กองวิศวกรรมสถานีไฟฟ้าแรงสูง



REV.No.	JOB No.	JOB DESCRIPTION	DRAWN	DESIGNED	VERIFIED	VALIDATED	RECOMMENDED	CONCURRED	APPROVED	DATE
-	BBS1-01-S01	NEW 230 kV AIS SUBSTATION	-	-	-	-	-	-	-	-

ELECTRICITY GENERATING AUTHORITY OF THAILAND			
THITWAT	RECOMMENDED AND VALIDATED	DRAWING NAME	
DESIGNED	CONCURRED	BHUMBOL 2 SUBSTATION	
VERIFIED	APPROVED	DESCRIPTION OF DETAIL DRAWING	
		SINGLE LINE DIAGRAM	
	DATE	JOB No.	DWG.No.
		BBS1-01-S01	BB2-S-1