

## **EGAT's Privacy Notice on Procurement, Inventory Management and Contract Administration**

**Electricity Generating Authority of Thailand (EGAT)** has performed the protection of the Personal Data regarding procurement, inventory management and contract administration to be in accordance with **the Personal Data Protection Act B.E. 2562** (the "2019 PDPA"), which comes into effect on June 1, 2022.

Details about EGAT's Privacy Notice on Procurement, Inventory Management and Contract Administration are available for you at [https://www.egat.co.th/privacy-notice-procurement\\_en.html](https://www.egat.co.th/privacy-notice-procurement_en.html) or the below QR Code.



## **The Redaction of Sensitive Personal Data**

EGAT has announced the Privacy Notice on Procurement, Inventory Management and Contract Administration for the collection, use or disclosure of Personal Data, excluding the Sensitive Personal Data.

Should the documents you wish to submit to EGAT contain the Sensitive Personal Data as defined in Section 26 of the 2019 PDPA, pertaining to racial, ethnic origin, political opinions, cult, religious or philosophical beliefs, sexual behavior, criminal records, health data, disability, trade union information, genetic data, biometric data, or of any data which may affect you in the same manner, you shall redact or conceal such data before submitting to EGAT.

## ประกาศความเป็นส่วนตัว (Privacy Notice) สำหรับการจัดซื้อจัดจ้าง การบริหารพัสดุ และการบริหารสัญญาของ กฟผ.

การไฟฟ้าฝ่ายผลิตแห่งประเทศไทย (กฟผ.) ได้ดำเนินการคุ้มครองข้อมูลส่วนบุคคลสำหรับการจัดซื้อจัดจ้าง การบริหารพัสดุ และการบริหารสัญญา เพื่อให้เป็นไปตามพระราชบัญญัติคุ้มครองข้อมูลส่วนบุคคลของประเทศไทย พ.ศ. 2562 (PDPA) ซึ่งมีผลบังคับใช้อย่างครบถ้วน ตั้งแต่วันที่ 1 มิถุนายน 2565 ทั้งนี้ ท่านสามารถศึกษารายละเอียดประกาศความเป็นส่วนตัว (Privacy Notice) สำหรับการจัดซื้อจัดจ้าง การบริหารพัสดุ และการบริหารสัญญา ได้ที่ <https://www.egat.co.th/privacy-notice-procurement.html> หรือที่ QR Code ด้านล่าง



### การขิดฆ่าข้อมูลส่วนบุคคลอ่อนไหว

กฟผ. มีประกาศความเป็นส่วนตัว (Privacy Notice) สำหรับการจัดซื้อจัดจ้าง การบริหารพัสดุ และการบริหารสัญญา เพื่อใช้ในการเก็บรวบรวม ใช้ หรือเปิดเผย ข้อมูลส่วนบุคคล แต่ไม่เก็บข้อมูลส่วนบุคคลอ่อนไหว หากเอกสารของท่านที่ต้องส่งมอบให้ กฟผ. มีข้อมูลส่วนบุคคลอ่อนไหวตามที่ถูกบัญญัติไว้ในมาตรา 26 ของ PDPA ดังนี้ เชื้อชาติ เผ่าพันธุ์ ความคิดเห็นทางการเมือง ความเชื่อในลัทธิ ศาสนาหรือปรัชญา พฤติกรรมทางเพศ ประวัติอาชญากรรม ข้อมูลสุขภาพ ความพิการ ข้อมูลสหภาพแรงงาน ข้อมูลพันธุกรรม ข้อมูลชีวภาพ หรือข้อมูลอื่นใด ซึ่งกระทบต่อเจ้าของข้อมูลส่วนบุคคลในทำนองเดียวกันรวมอยู่ด้วย ขอให้ท่านขิดฆ่า หรือปกปิดข้อมูลดังกล่าว ก่อนส่งมอบให้แก่ กฟผ.

**1<sup>st</sup> Draft of Terms of Reference,  
Announcement and Details of Medium Cost  
for Invitation to Bid No. LPLC-TX-01  
Supply of 333.33 MVA 500 kV Power Transformer  
Long-Term Investment Plan to Accommodate Large Power Consumer**

---

The Electricity Generating Authority of Thailand (EGAT) plans to call for proposals for the subject Invitation to Bid. Any person who has the authorization from the company, firm, joint venture or consortium who supplies or manufactures the equipment required under the subject invitation to Bid is allowed to submit a comment against the first draft of the Terms of Reference (TOR), the Announcement and the Details of Medium Cost attached herewith.

**How to Comment**

Those who would like to comment shall submit an official letter signed by the authorized person(s) together with the letter of authorization or the power of attorney, and addressed to “Chief, Procurement Department - Transmission System Segment, Central Procurement and Inventory Management Division”.

Comments shall be submitted via email address: [prattana.cha@egat.co.th](mailto:prattana.cha@egat.co.th) with all related documents attached (e.g. the letter of authorization and the power of attorney).

Comments shall be received by EGAT on or before **June 10, 2026**, Bangkok Standard Time, **otherwise the comments will not be taken into consideration.**

**EGAT reserves the right to change or not to change the terms and conditions contained in the Terms of Reference, the Announcement and the Details of Medium Cost subject to its consideration and such decision shall be final.**



Miss Benyalak Saralamba

Head, Procurement Section - Transmission System Segment 3

Date June 2, 2026

## Notice to Bidder

### Subject : Online Payment for Purchase of Bidding Documents

Please be informed of the online payment for purchase of bidding documents as follows:

- 1) Fill-out the Registration Form and the proof of payment in the link provided in <https://www4.egat.co.th/fprocurement/biddingeng>

Payment shall be made by bank transfer or telegraphic transfer to EGAT's account no. 109-6-01958-2 (swift code : KRTHTHBK), Krung Thai Bank Public Company Limited, Bangkruai Branch, Nonthaburi.

All bank charges and fees incurred by the payment of bidding documents shall be under the buyer's responsibility.

- 2) The registration will be deemed complete only upon successful processing of the payment and confirmation of funds received.
- 3) After the payment has been verified for approximately 3 working days, the in-charge officer will send the link for downloading the bidding documents together with the receipt to the purchaser's email address in the Registration Form.

\*\*\*\*\*



## ประกาศการไฟฟ้าฝ่ายผลิตแห่งประเทศไทย เรื่อง ประกวดราคาซื้อ เลขที่ LPLC-TX-01

การไฟฟ้าฝ่ายผลิตแห่งประเทศไทย (กฟผ.) มีความประสงค์จะซื้อ 333.33 MVA 500 kV Power Transformer สำหรับแผนลงทุนระยะยาวเพื่อรองรับกลุ่มผู้ใช้ไฟฟ้าขนาดใหญ่ โดยใช้งบประมาณ กฟผ.

**สถานที่ส่งมอบ** : ท่าเรือแหลมฉบัง / หน้าโรงงานผู้ผลิต

**ราคากลาง (รวมภาษีมูลค่าเพิ่มและค่าใช้จ่ายอื่นๆ)** : 418,000,000.- บาท

### **คุณสมบัติของผู้เสนอราคา**

1. ต้องเป็นนิติบุคคลผู้ผลิตหรือเป็นผู้มีอาชีพขายพัสดุตามประกาศ และต้องไม่เป็นผู้ทำงานซึ่งปลัดกระทรวงการคลังได้แจ้งเวียนชื่อไว้ หรือต้องไม่เป็นผู้ที่ กฟผ. ห้ามติดต่อหรือห้ามเข้าเสนอราคา หรือต้องไม่เป็นผู้ที่ได้รับผลของการสั่งให้นิติบุคคลหรือบุคคลอื่นเป็นผู้ทำงานตามคำสั่ง กฟผ.
2. ต้องไม่เป็นผู้มีผลประโยชน์ร่วมกันกับผู้เสนอราคารายอื่น ณ วันประกาศประกวดราคาครั้งนี้เป็นต้นไป หรือต้องไม่เป็นผู้กระทำการอันเป็นการขัดขวางการแข่งขันราคาอย่างเป็นธรรมในการดำเนินการประกวดราคาครั้งนี้
3. ต้องไม่เป็นที่ปรึกษาของ กฟผ. หรือมีส่วนร่วมในบริษัทที่ปรึกษาของ กฟผ. ในงานนี้ หรือต้องไม่มีผู้ปฏิบัติงาน กฟผ. เข้าไปมีส่วนร่วมในกิจการของผู้เสนอราคา ไม่ว่าจะในฐานะผู้ถือหุ้นที่มีสิทธิควบคุมการจัดการ กรรมการ ผู้อำนวยการ ผู้จัดการ พนักงาน ลูกจ้าง ตัวแทน หรือที่ปรึกษา ยกเว้น ในกรณีที่ผู้ปฏิบัติงานได้รับคำสั่งอย่างเป็นทางการจาก กฟผ. ให้ไปปฏิบัติงานหรือเข้าร่วมในกิจการของผู้เสนอราคา
4. ต้องไม่เป็นผู้ได้รับเอกสิทธิ์หรือความคุ้มกัน ซึ่งอาจปฏิเสธไม่ยอมขึ้นศาลไทย เว้นแต่รัฐบาลของผู้เสนอราคาได้มีคำสั่งให้สละสิทธิ์และความคุ้มกันเช่นนั้น
5. ผู้ประสงค์เข้าประกวดราคาในนามของกิจการร่วมค้าหรือกิจการค้าร่วม (Joint Venture or Consortium) จะต้องดำเนินการทุกขั้นตอนของการประกวดราคาในนามของกิจการร่วมค้าหรือกิจการค้าร่วม ตั้งแต่การเสนอราคาจนถึงสิ้นสุดข้อผูกพันกับ กฟผ.

### **การขายเอกสารประกวดราคา**

ผู้สนใจติดต่อซื้อเอกสารประกวดราคา ในราคาชุดละ 5,000.- บาท ในวันทำการระหว่างเวลา 08:00 น. ถึง 15:00 น. ตั้งแต่วันที่ \_\_\_\_\_ ถึงวันที่ \_\_\_\_\_ ทั้งนี้ สามารถดูรายละเอียดการซื้อเอกสารประกวดราคาได้ที่เว็บไซต์ <http://www4.egat.co.th/fprocurement/biddingeng> หรือสอบถามข้อมูลเพิ่มเติมได้ทางโทรศัพท์ หมายเลข 0 2436 0346 หรือ อีเมล [procurement.tse@egat.co.th](mailto:procurement.tse@egat.co.th)

### **การยื่นซองประกวดราคา**

กำหนดยื่นซองประกวดราคา ในวันที่ \_\_\_\_\_ เวลา 09:00 น. ถึง 10:00 น. และเปิดซองประกวดราคาเวลา 10:00 น. ณ ห้องประกวดราคา ชั้น 1 อาคาร ท.137 การไฟฟ้าฝ่ายผลิตแห่งประเทศไทย เชียงสะพานพระราม 7 จังหวัดนนทบุรี

ประกาศ ณ วันที่ \_\_\_\_\_

(นางสาววัลลา ชิวธนากรณกุล)

หัวหน้ากองจัดซื้อจัดจ้างสายงานระบบส่ง



**Invitation to Bid No. LPLC-TX-01**  
**Supply of 333.33 MVA 500 kV Power Transformer**  
**Long-Term Investment Plan to Accommodate Large Power Consumer**

The Electricity Generating Authority of Thailand (EGAT) is calling for the subject Invitation to Bid to be financed by EGAT's fund.

**Place of Delivery** : Learn Chabang Port / Ex-works

**Medium Cost (including Value Added Tax and other expenses)** : THB 418,000,000.-

**Eligibility of Bidders**

1. The Bidder shall be a juristic person who manufactures or provides such materials or services and shall not be named in the List of Work Abandoners published by the Permanent Secretary, Ministry of Finance, and/or in the Debarment List and/or in the List of Work Abandoners declared by EGAT.
2. The Bidder shall not be a Jointly Interested Bidder with other Bidders as from the date of EGAT's issuance of the Invitation, or shall not be a person who undertakes any action as an "Obstruction of Fair Price Competition" for this Invitation.
3. The Bidder shall not either be EGAT's consultant or involve in EGAT's consultancy company under this Invitation to Bid, or shall not have EGAT's personnel involved in his business as shareholder having voting right that can control his business, director, manager, officer, employee, agent, or consultant except those who are officially ordered by EGAT to act or participate therein.
4. The Bidder shall not be the person who is privileged or protected not to be taken any legal proceedings under Thai Court; Provided that such Bidder's government declares that such special privilege is waived.
5. The Bidder who is a joint venture or consortium shall carry out all the work under such formation from the time of bidding until the fulfillment of the Contract.

**Availability of Bidding Documents**

Bidding Documents are available for online purchase during 8:00 hrs. to 15:00 hrs., Bangkok Standard Time, as from \_\_\_\_\_ to \_\_\_\_\_ at USD 170.- or THB 5,000.- per copy, non-refundable.

Please find more details for online purchasing process at <http://www4.egat.co.th/fprocurement/biddingeng> or contact for further information at telephone no. 66 2436 0346 or [procurement.tse@egat.co.th](mailto:procurement.tse@egat.co.th).

**Delivery of Bids**

Bids shall be submitted at Bidding Room, 1<sup>st</sup> Floor, Tor 137 Building at EGAT's Head Office, Nonthaburi during 9:00 hrs. to 10:00 hrs., Bangkok Standard Time, \_\_\_\_\_ and will be opened publicly at 10:00 hrs.

ELECTRICITY GENERATING AUTHORITY OF THAILAND

(Date of Announcement)

(Miss Wallapa Chewadhnakorlku)  
Chief, Procurement Department – Transmission System Segment

ตารางแสดงวงเงินงบประมาณที่ได้รับจัดสรรและราคากลาง(ราคาอ้างอิง)  
ในการจัดซื้อจัดจ้างที่มีใช้งานก่อสร้าง

1. ชื่อโครงการ Bid No. LPLC-TX-01

การจัดซื้อ 333.33 MVA 500 kV Power Transformer

แผนลงทุนระยะยาวเพื่อรองรับกลุ่มผู้ใช้ไฟฟ้าขนาดใหญ่

/หน่วยงานเจ้าของโครงการ ฝ่ายแผนงานและโครงการระบบส่ง การไฟฟ้าฝ่ายผลิตแห่งประเทศไทย

2. วงเงินงบประมาณที่ได้รับจัดสรร

แผนลงทุนระยะยาวเพื่อรองรับกลุ่มผู้ใช้ไฟฟ้าขนาดใหญ่ งบประมาณ 1,570 ล้านบาท

3. วันที่กำหนดราคากลาง 16 เมษายน 2569 (วันที่ ชรว. อนุมัติ )

ราคารวมภาษีมูลค่าเพิ่มและค่าใช้จ่ายอื่นๆ เป็นเงิน 418,000,000.00 บาท ราคา/หน่วย ตามเอกสารแนบ

4. แหล่งที่มาของราคากลาง

หลักเกณฑ์การกำหนดราคากลางการจัดซื้อและจัดจ้างงานก่อสร้างระบบส่งไฟฟ้าของสายงานพัฒนาระบบส่ง

5. รายชื่อเจ้าหน้าที่ผู้กำหนดราคากลาง

5.1 นายณัฐวัฏ วงศ์เทพวานิชย์ หมพ-ร., กวอ-ร.

5.2 นางสาวกาญจนา ผลสวัสดิ์ วศ.7, หมพ-ร., กวอ-ร.

หมายเหตุ ค่าใช้จ่ายอื่นๆ ได้แก่ ค่าใช้จ่ายที่ กฟผ. ต้องจ่ายตามวิธีการพิจารณาเปรียบเทียบราคาที่กำหนดไว้ในเอกสารประกวดราคา เช่น อากรขาเข้า เป็นต้น

**MEDIUM COST FOR BID NO. LPLC-TX-01**  
**SUMMARY OF BID PRICE**  
**SUPPLY OF 333.33 MVA 500 KV POWER TRANSFORMER**  
**LONG-TERM INVESTMENT PLAN TO ACCOMMODATE LARGE POWER CONSUMER**

No.	Description	Currency	Supply of Equipment	Supply of Equipment	Foreign Currency (excluding VAT)	Local Currency (excluding VAT) Baht
			Foreign Supply	Local Supply		
			CFR Thai Port	Ex-works Price (excluding VAT) Baht		
			Amount	Amount		
1	Schedule 1 : 333.33 MVA, 500 kV Auto-Transformer	THB	387,524,000.00		620,000.00	
<b>BID PRICE</b>		<b>THB</b>	<b>387,524,000.00</b>	<b>Baht</b>	<b>620,000.00</b>	<b>Baht</b>
<b>IMPORT DUTY</b>		<b>THB</b>	<b>72,400.00</b>	<b>Baht</b>		<b>Baht</b>
<b>CUSTOM CLEARANCE</b>		<b>THB</b>	<b>2,325,144.00</b>	<b>Baht</b>		<b>Baht</b>
<b>VAT</b>		<b>THB</b>	<b>27,131,748.00</b>	<b>Baht</b>	<b>43,400.00</b>	<b>Baht</b>
<b>SUMMARY OF BID PRICE</b>		<b>THB</b>	<b>417,053,292.00</b>	<b>Baht</b>	<b>663,400.00</b>	<b>Baht</b>
<b>TOTAL MEDIUM COST</b>		<b>THB</b>	<b>417,716,692.00</b>			
<b>TOTAL MEDIUM COST (ROUND)</b>		<b>THB</b>	<b>418,000,000.00</b>			

  
 นายสมชัย เจริญศรีเกษม  
 ผู้อำนวยการฝ่ายวิศวกรรมระบบส่ง  
 16 Apr 2026

**MEDIUM COST FOR BID NO. LPLC-TX-01**  
**Schedule 1 : 333.33 MVA, 500 kV Auto-Transformer**  
**SUPPLY OF 333.33 MVA 500 KV POWER TRANSFORMER**  
**LONG-TERM INVESTMENT PLAN TO ACCOMMODATE LARGE POWER CONSUMER**

Item No.	Description	Qty.	Unit	Currency	Supply of Equipment				Supply of Equipment		Foreign Currency (excluding VAT)	Local Currency (excluding VAT) Baht	
					Foreign Supply				Local Supply				
					FOB Vessel Unit Price	Cost of Transportation to Thai Port Unit Price	CFR Thai Port Unit Price      Amount		Ex-works Price (excluding VAT) Baht Unit Price      Amount				
1-1	333.33 MVA 525/√3,242/√3-22 kV single phase unit autotransformer complete with tank mounted surge arresters, insulating oil and accessories as per Ratings and Features RF TX991A	3		THB	96,700,000.00		96,700,000.00	290,100,000.00			XXXXX	XXXXX	
1-2	333.33 MVA 525/√3,242/√3-22 kV single phase unit autotransformer complete with tank mounted surge arresters, insulating oil and accessories as per Ratings and Features RF TX991A, Supply as spare parts	1		THB	96,700,000.00		96,700,000.00	96,700,000.00			XXXXX	XXXXX	
1-3	Common Control Cabinet as per Specification No. 711 for Item No. 1-1	1		THB	682,000.00		682,000.00	682,000.00			XXXXX	XXXXX	
1-4	Complete Set of one or two units of each type and each size of auxiliary relay (two units are required where five units or more of each type and each size are provided per one transformer bank), Supply as spare parts	1		THB	42,000.00		42,000.00	42,000.00			XXXXX	XXXXX	
1-5	Cost of installation supervisor for Item No. 1-1		Man-day	THB	XXXXX	XXXXX	XXXXX	XXXXX	XXXXX	XXXXX	465,000.00		
1-6	Cost of installation supervisor for Item No. 1-2		Man-day	THB	XXXXX	XXXXX	XXXXX	XXXXX	XXXXX	XXXXX	155,000.00		
	Equipment which shall be used together as a complete set referring to Article relevant to Liquidated Damages for Late Delivery of Equipment are Item No. 1-3 with 1-1.												
<b>Total Price for Schedule 1</b>				THB	<b>387,524,000.00</b>				Baht			<b>620,000.00</b>	Baht

  
 นายสมชัย เจริญศรีเกษม  
 ผู้อำนวยการฝ่ายวิศวกรรมระบบส่ง  
 16 Apr 2026

**Contract No.**

**Invitation to Bid No. LPLC-TX-01**

---

**ELECTRICITY GENERATING AUTHORITY OF THAILAND**



**BIDDING DOCUMENTS**

**SUPPLY OF 333.33 MVA 500 kV POWER TRANSFORMER**

**LONG-TERM INVESTMENT PLAN  
TO ACCOMMODATE LARGE POWER CONSUMER**

**EGAT'S FUND**

---

**BIDDER :** \_\_\_\_\_

---

(2026)

**INVITATION TO BID NO. LPLC-TX-01**  
**SUPPLY OF 333.33 MVA 500 kV POWER TRANSFORMER**  
**LONG-TERM INVESTMENT PLAN**  
**TO ACCOMMODATE LARGE POWER CONSUMER**  
**EGAT'S FUND**

---

**CONTENTS**

CONFIRMATION FORM

DISCOUNT FORM

ANTI-CORRUPTION COMPLIANCE CHECKLIST

ADDITIONAL REGULATION

IMPORTANT INFORMATION

DATA SHEET

SECTION A INVITATION TO BID

SECTION B INSTRUCTIONS TO BIDDERS

SECTION C PROPOSAL

SECTION D CONTRACT

SECTION E GENERAL CONDITIONS

SECTION F SPECIAL CONDITIONS

SECTION G RATINGS AND FEATURES

SECTION H BILL OF MATERIALS (None)

SECTION I SPECIFICATIONS

SECTION J DRAWINGS

## CONTENTS

<u>Article No.</u>	<u>Description</u>	<u>Page</u>
	Confirmation Form	-
	Discount Form	-
	Anti-Corruption Compliance Checklist	-
	Additional Regulation	1-11
	Important Information	i
	Data Sheet	i
<b>SECTION A : <u>INVITATION TO BID</u></b>		
A-1	Invitation	A1
A-2	Eligibility of Bidders: General Requirements	A1
A-3	Eligibility of Bidders: Technical Requirements	A2
A-4	Joint Venture or Consortium	A6
A-5	Preparation and Delivery of Bids	A6
A-6	Availability of Bidding Documents	A7
<b>SECTION B : <u>INSTRUCTIONS TO BIDDERS</u></b>		
	Overview of the Procurement Process	B1
B-1	Preparation of Bids	B2
B-2	Bid Prices	B3
B-3	Bid Security	B5
B-4	Validity of Bids	B6
B-5	Delivery of Bids	B6
B-6	Withdrawal of Bids	B6
B-7	Interpretation of Bidding Documents before Bid Opening	B6

<u>Article No.</u>	<u>Description</u>	<u>Page</u>
B-8	Information to be Submitted with Bid	B7
B-9	Deviations from Specifications	B9
B-10	Rejection of Bids	B9
B-11	Delivery Time	B9
B-12	Evaluation and Comparison of Bids	B10
B-13	Acceptance of Bids	B11
B-14	Appeal	B11
B-15	Award of Contract	B12
B-16	Bidder's Responsibility	B12
B-17	Supplemental Notices	B12
B-18	Cost of Bidding	B13
B-19	Cancellation of Bid	B13
	Specimen of Bid Security	B14
<b><u>SECTION C : PROPOSAL</u></b>		
C-1	Price Schedule	C1
C-2	Penalty for Equipment Not Meeting Guaranteed Characteristics	C2
C-3	Guaranteed Delivery Time	C2
C-4	Drawing and Document Submission Schedule	C2
C-5	Estimate of Deliveries	C2
C-6	Bid Security	C3
C-7	Supplemental Notices	C3
	Part 1 : Price Proposal	Project 1-C1
	Part 2 : Proposal Data	Part 2-C1
	Part 3 : Delivery Schedule and Distribution List	Part 3-C1

<u>Article No.</u>	<u>Description</u>	<u>Page</u>
--------------------	--------------------	-------------

**SECTION D : CONTRACT**

D-1	Contract Documents	D1
D-2	Acceptance of Proposal	D2
D-3	Agreement	D2
D-4	Obligation of Contractor	D2
D-5	Obligation of EGAT	D2
D-6	Mutual Obligations	D3
D-7	Deposit of Performance Security	D3
D-8	Assignment	D3
D-9	Notices	D3
D-10	Integration	D4
D-11	Counterpart	D4

**SECTION E : GENERAL CONDITIONS**

E-1	Definitions	E1
E-2	Intent of Contract Documents	E2
E-3	Applicable Law and Legal Jurisdiction	E3
E-4	Statutory Requirements	E3
E-5	Patents and Copyrights	E3
E-6	Subcontracts	E4
E-7	Export Charges	E4
E-8	Import Duty and Taxes	E4
E-9	Value Added Tax	E5
E-10	Income and Other Taxes	E6

<u>Article No.</u>	<u>Description</u>	<u>Page</u>
E-11	Fees and Duties	E7
E-12	Performance Security	E8
E-13	Inspection and Tests	E9
E-14	Preparation for Shipment and/or Delivery	E11
E-15	Clearance and Weight Limitations	E13
E-16	Shipment	E13
E-17	Documents Required for Each Shipment	E15
E-18	Force Majeure	E18
E-19	Transportation Insurance	E19
E-20	Transfer of Title	E19
E-21	Changes and Extra or Omitted Work	E19
E-22	Termination and Suspension of Contract	E20
E-23	Default and Termination	E20
E-24	Indemnification by the Contractor	E21
E-25	Limitation of Liability	E22
E-26	Consequential Damages	E22
E-27	Vesting of Contract in Receiver	E22
E-28	Extension of Time	E23
E-29	Failure to Meet Requirements	E23
E-30	Operation or Use of Unsatisfactory Equipment	E26
E-31	Dispute Resolution	E26
E-32	Language and Numbers	E26
	Specimen of Guarantee	E27
	Instructions for Packaging	E28

<u>Article No.</u>	<u>Description</u>	<u>Page</u>
--------------------	--------------------	-------------

**SECTION F : SPECIAL CONDITIONS**

F-1	Scope of Work	F1
F-2	Responsibility of Contractor	F1
F-3	Cooperation with Other Contractors	F1
F-4	Supervision of Installation	F2
F-5	Acceptance Tests	F3
F-6	Failure to Meet Performance Guarantees	F3
F-7	Acceptance Certificate	F3
F-8	Payment	F4
F-9	Liquidated Damages for Late Delivery of Equipment	F8
F-10	Maintenance Guarantee	F9
F-11	Drawings and Documents to be Furnished by Contractor	F11
F-12	Maintenance Security	F14
	Specimen of Maintenance Guarantee	F16
	Drawings and Documents to be Furnished by the Contractor (For Control and Protection Equipment)	F17
	Drawings and Documents to be Furnished by the Contractor (For All Equipment except Control and Protection Equipment)	F18

**SECTION G : RATINGS AND FEATURES**

G-1	Ratings and Features	G1
-----	----------------------	----

**SECTION H : BILL OF MATERIALS (None)**

- - -

**Article No.**

**Description**

**Page**

**SECTION I : SPECIFICATIONS**

I-1	Specifications	I1
-----	----------------	----

**SECTION J : DRAWINGS**

J-1	Drawings	J1
-----	----------	----

DRAFT

**CONFIRMATION FORM**

**(INDIVIDUAL COMPANY / JOINT VENTURE)**

**INVITATION TO BID NO. LPLC-TX-01**

**SUPPLY OF 333.33 MVA 500 kV POWER TRANSFORMER**

**LONG-TERM INVESTMENT PLAN  
TO ACCOMMODATE LARGE POWER CONSUMER**

---

By signing in the space provided below, we confirm that:-

- According to “Eligibility of Bidders” and in addition to the Documentary List attached to the bidding documents, we are not a Jointly Interested Bidder with the other bidders as from the date of EGAT’s issuance of the subject Invitation and are not a person who undertakes any actions as an “Obstruction of Fair Price Competition”.
- According to Article B-8. Information to be Submitted with Bid, we confirm
  - Registration with the Revenue Department as a value added tax registrant in Thailand as per certificate of value added tax registration (จพ.20) attached.
  - Non-Registration as a value added tax registrant in Thailand, but will register later.
  - Non-Registration as a value added tax registrant in Thailand and will not register.

Confirmed :

.....

By : .....

Title : .....

Date : .....

**CONFIRMATION FORM**

(CONSORTIUM)

**INVITATION TO BID NO. LPLC-TX-01**

**SUPPLY OF 333.33 MVA 500 kV POWER TRANSFORMER**

**LONG-TERM INVESTMENT PLAN  
TO ACCOMMODATE LARGE POWER CONSUMER**

---

**Member No. ... of the consortium:**

By signing in the space provided below, we confirm that:-

- According to “Eligibility of Bidders” and in addition to the Documentary List attached to the bidding documents, we are not a Jointly Interested Bidder with the other bidders as from the date of EGAT’s issuance of the subject Invitation and are not a person who undertakes any actions as an “Obstruction of Fair Price Competition”.
- According to Article B-8. Information to be Submitted with Bid, we confirm
  - Registration with the Revenue Department as a value added tax registrant in Thailand as per certificate of value added tax registration (ภพ.20) attached.
  - Non-Registration as a value added tax registrant in Thailand, but will register later.
  - Non-Registration as a value added tax registrant in Thailand and will not register.

Confirmed :

.....

By : .....

Title : .....

Date : .....

**DISCOUNT FORM**  
*(Excluding VAT)*

**INVITATION TO BID NO. LPLC-TX-01**  
**SUPPLY OF 333.33 MVA 500 kV POWER TRANSFORMER**  
**LONG-TERM INVESTMENT PLAN**  
**TO ACCOMMODATE LARGE POWER CONSUMER**

**Bidder :** \_\_\_\_\_

By signing in the space provided below, we confirm that:-

- we offer no discount.
- we offer discount(s) as follows:

Details of discount	Currency	Amount

Remarks :

- ***The Bidder shall apply discount(s) on any item(s), schedule(s), or the total price, excluding Value Added Tax (VAT).***
- The above discount(s) shall not be subject to any conditions. Discount with conditions shall not be considered.
- This Discount Form, together with Bidder's Summary of Bid Price, will be publicly presented on a screen to all Bidders in the bid opening room at the time of bid opening.

Confirmed by authorized person(s):

.....

By : .....

Title : .....

Date : .....

**Anti-Corruption Compliance Checklist**

**(Rev.1)**

Bidders shall provide written minimum standards of the policy and directions for anti-corruption in relation to procurement (“Minimum Standards”) together with supporting evidence pursuant to the Notification of the Anti-Corruption Co-operation Committee Concerning Minimum Standards of the Policy and Directions for Anti-Corruption in Relation to Procurement Required to be put in place by the Business Operator, in accordance with Section 19 of the Public Procurement and Supplies Administration Act, B.E. 2560 (A.D. 2017). This checklist shall be submitted with Bids.

Project: (Please specify the project for which you are bidding).....

State Agency: Electricity Generating Authority of Thailand

Bidder Name: (Please specify the bidder’s name).....

Please mark  one of the following boxes  that applies to the bidders\* and complete all details in the space provided:

1. Have one of the following certificates:
- Certificate under ISO 37001 Anti-Bribery Management Systems, or
  - Certificate from the Thai Private Sector Collective Action against Corruption, or
  - Certificate as prescribed by the Anti-Corruption Co-operation Committee: (Please specify the certificate name)
- Validity period: .....(Please specify the validity period of the chosen certificate).....
- Please attach an evidence of the chosen certificate.

2. Do not have a certificate as specified in item 1, but have the Minimum Standards with one of the following validity:
- Perpetual Validity, or
  - Validity period:.....(Please specify the validity period of the Minimum Standards).....

Details of the Minimum Standards and supporting evidence are as follows: (Please mark  in the “Yes” or “No” column):

Item	Yes	No	Reference Evidence (Please specify Article)
1. Bidders have any clearly defined written anti-corruption policies that is regularly updated.			
2. Bidders have any clearly defined written guidelines, methods, or measures for preventing corruption in procurement that is regularly updated, including but not limited to:			
2.1 Code of Conduct			
2.2 Internal unit or personnel explicitly responsible for the prevention of corruption			
2.3 Penalties or regulations against corruption			
2.4 Channels or systems to report any suspicious or queries related to corruption			
2.5 Anti-corruption training plan			
3. Bidders have communicated and publicized the anti-corruption policies and guidelines relation to procurement as stated in items 1 and 2.			
4. Bidders have provided training on anti-corruption to directors, executives, or employees.			
5. The anti-corruption policies and guidelines are reviewed at least every three (3) years.			

We hereby certify that the information provided above and the supporting evidence are true and correct.

Signed .....  
 (.....)  
 Name of Bidder  
 Stamp company seal (if any)  
 Date.....

\* Notes:

1. The certificate or Minimum Standards shall remain valid and effective from the bid opening date until the date of receipt of the final payment under the contract.
2. If the bidders do not have a certificate, the bidders shall fulfill all items stipulated in the above table to meet the Eligibility of Bidders’ criteria for participation in this procurement.
3. In case of Consortium of two (2) or more firms, partnership or companies, this checklist of each member shall be submitted separately.
4. In the case of an unincorporated Joint Venture, each participant shall submit this checklist separately.
5. This checklist is a translation from Thai based on the Notification of the Anti-Corruption Co-operation Committee Concerning Minimum Standards of the Policy and Directions for Anti-Corruption in Relation to Procurement Required to be put in place by the Business Operator, in accordance with Section 19 of the Public Procurement and Supplies Administration Act, B.E. 2560 (A.D. 2017), dated September 25, 2024. In the event of any discrepancy, the Thai version in the notification shall prevail.

## Additional Regulation

This Regulation shall apply to the Enquiry, Bid for Supply, Lease, Hire of Work, or Hire of Consultant by Way of Selection.

1. Attachments
  - 1.1 Definitions
    - 1.1.1 Jointly Interested Bidder
    - 1.1.2 Obstruction of Fair Price Competition
  - 1.2 Documentary List
2. Bidder's Qualifications
  - 2.1 The Bidder shall professionally be in the business of providing materials or services or leasing or consultancy services, as the case may be, and shall not be named in the list of work abandoners published by the Permanent Secretary, Ministry of Finance, and/or in the debarment list and/or the list of work abandoners declared by EGAT according to Article 5 of this Regulation.
  - 2.2 The Bidder shall not be a Jointly Interested Bidder with other bidders as from the date of EGAT's issuance of the Invitation for Bid/Enquiry or the Invitation Letter/ Terms of Reference for the consultancy services, as the case may be, or shall not be a person who undertakes any action as an "Obstruction of Fair Price Competition" described in Article 1.1 – Definitions.
  - 2.3 The Bidder shall not have EGAT's personnel involve in his business as shareholder having voting right that can control his business, director, manager, officer, employee, agent or consultant except for the ones who are officially ordered by EGAT to act or participate therein.
3. Information to be Submitted with Bid

The Bidder shall submit with his bid the documents according to Article 1.2 - Documentary List, including but not limited to, the following documents :-

  - 3.1 Where the Bidder is a juristic person :
    - (a) ordinary partnership or limited partnership  
a certified copy of affidavit of incorporation, name list of managing partners, list of persons entrusted with controlling power (if any), as well as a certified copy of registration for value added tax (if any).
    - (b) limited company or public limited company  
a certified copy of affidavit of incorporation, memorandum of association, name list of managing directors, list of persons entrusted with controlling power (if any) and name list of major shareholders, as well as a certified copy of registration for value added tax (if any).

Such certified copy of affidavit of incorporation with the validity of not more than six (6) months from the date of certification to the opening date of Bid/Enquiry or the date of Invitation Letter/Terms of Reference in case of consultancy services, as the case may be, shall certify at least the following information :

- (i) Type of a juristic person : an ordinary partnership, a limited partnership, a limited company, a public limited company,
- (ii) Name according to (i),
- (iii) Number and names of managing partners or managing directors,
- (iv) Number and names of managing partners or managing directors authorized to act on behalf of the company,
- (v) Amount of shareholders' equity or registered capital,
- (vi) Authority of managing partner in case of partnership,
- (vii) Location of head office,
- (viii) Registration purposes,
  
- (ix) Scope of work indicated in business permit license of a foreign juristic person who registers in Thailand,
- (x) Other documents e.g. changes or additions to the above documents, branches (if any).

3.2 Where the Bidder is a natural person or a group of persons other than a juristic person :

a certified copy of :

- identity card **or passport (if non-Thai national)**
- partnership agreement or contract (if any)
- partners' identity cards **or passport (if non-Thai national)**
- registration required by Ministry of Commerce of Thailand
- registration for value added tax (if any)

3.3 Where the Bidder is a joint venture / consortium :

a certified copy of :

- association agreement
- identity card or passport (if non Thai national)  
(The participant in the joint venture or consortium is not a juristic person.)
- all documents specified in *Item 3.1* of Additional Regulation  
(The participant in the joint venture or consortium is a juristic person.)

3.4 Other documentary evidence as required per *Item 3, 6 or 8* of Documentary List (if any).

4. Preliminary Examination

4.1 EGAT shall examine the qualification of all bidders to determine whether any bidder is a Jointly Interested Bidder as from the date of EGAT's issuance of the Invitation for Bid/Enquiry or the Invitation Letter/Terms of Reference for the consultancy services, as the case may be, and/or undertakes any action as an "Obstruction of Fair Price Competition" before or during the bid opening. If there is evidence showing that any bidder is a Jointly Interested Bidder or undertakes any action as an "Obstruction of Fair Price Competition", EGAT shall delete his name from the list of bidders and inform such bidder by written notice hereof.

4.2 The Bidder whose name is deleted according to Article 4.1, may, within fifteen (15) calendar days from the date of receipt of EGAT's written notice, appeal to EGAT, explaining reasons together with relevant documents for EGAT's reconsideration.

In case EGAT agrees with the objection of the appellant but considers that the cancellation of enquiry/bidding will be beneficial to EGAT, EGAT may, at its sole discretion, cancel such bid. In the event that the Bidder who undertakes any action as an "Obstruction of Fair Price Competition" does not appeal or, after his appeal, EGAT does not agree with his objection, such Bidder shall be regarded as a work abandoner.

EGAT's decision shall be notified to the appellant in writing and such decision shall be final and conclusive.

5. Reservation of the Right for Proposal and Others

In case any juristic person is regarded as a work abandoner by EGAT and such abandonment is caused by the manager, the managing partner, the managing director, the executive or the person authorized to manage the business of that juristic person, EGAT shall also include his name as a work abandoner.

In case any juristic person is regarded as a work abandoner by EGAT, such decision shall also be applied to other juristic persons of the same business where its manager, managing partner, managing director, executive, or person authorized to manage the business is the same person who is the manager, managing partner, managing director, executive, or person authorized to manage the business of the juristic person who is regarded as a work abandoner by EGAT as aforesaid.

In case any natural person is regarded as a work abandoner by EGAT, such decision shall also be applied to other juristic persons who submit the proposal and have such natural person as the manager, managing partner, managing director, executive or person authorized to manage the business of such juristic persons

## 1.1 Definitions

These definitions shall apply to the Enquiry, Bid for Supply, Lease, Hire or Work, or Hire of Consultant by Way of Selection.

1.1.1 **“Jointly Interested Bidder”** means a natural person or juristic person who submits bid to EGAT for the supply of goods, lease, hire of work, or hire of consultant by way of selection, as the case may be, and who has an interest, either directly or indirectly, in the business of another natural person or juristic person whose bid is also submitted to EGAT in this bidding.

The interest, either direct or indirect, in another natural person or juristic person as aforesaid includes the relationship in the following manners :

- (1) Management relationship, whereby the manager, the managing partner, the managing director, the executive or the person authorized to manage the business of a natural person or a juristic person has the power, or is able to exercise the power, in managing the business of the other one or more natural persons or juristic persons whose bids are also submitted to EGAT in this bidding.
- (2) Capital relationship, whereby a partner in an ordinary partnership or a partner with unlimited liability in a limited partnership or a major shareholder in a limited company or a public limited company is a partner in the other one or more ordinary partnerships or limited partnerships, or is a major shareholder in the other one or more limited companies or public limited companies whose bids are also submitted to EGAT in this bidding.
- (3) Cross relationship between (1) and (2), whereby the manager, managing partner, managing director, executive or person authorized to manage the business of a natural person or juristic person is a partner in the other one or more ordinary partnerships or limited partnerships, or is a major shareholder in the other one or more limited companies or public limited companies whose bids are also submitted to EGAT in this bidding, or *vice versa*.

**“Major shareholder”** means a shareholder who holds more than twenty five (25) percent of stake in such an enterprise or at another percentage determined by the Governor as he deems expedient for some types or sizes of enterprises.

Holding of position, being a partner or shareholding as aforesaid by the spouse or minor of the person in (1), (2) or (3) shall be deemed the holding of position, being a partner or shareholding by such person.

If any bidder uses the name of another person as the manager, managing partner, managing director, executive, partner or shareholder, but in which case he himself in fact exercises the power in management or he himself is the real partner or shareholder of the partnership or limited company or public limited company, as the case may be, and the related partnership or limited company or public limited company whose bid is also submitted to EGAT in this bidding, that bidder shall be deemed to have a relationship under (1), (2) or (3), as the case may be.

1.1.2 ***“Obstruction of Fair Price Competition”*** means any act committed by a bidder or bidders causing hindrance or obstruction or impeding the opportunity for fair price competition in the tendering of bid to EGAT, whether done by collusion, or by granting, requesting, or agreeing to grant, demand, accept or agreeing to accept money or property or other benefit or by committing an act of violence or by threatening to commit an act of violence or presenting a false document or doing any act in bad faith, with the objective of acquiring benefit among the other bidders or in order to give benefit to any specific bidder so that such person will be entitled to enter into a contract with EGAT or in order to avoid fair price competition, or in order to take advantage to EGAT which not being usual business practices.

DRAFT

1.2 Documentary List

This documentary list shall apply to the Enquiry, Bid for Supply, Lease, Hire of Work, or Hire of Consultant by Way of Selection.

		No. of page(s)	For EGAT only	
<b><u>Thai National Bidder</u></b>				
[ ]	1. Where the Bidder is a natural person or a group of persons other than a juristic person			
( )	(a) Natural Person		Yes	No
	- Certified copy of identity card .....		<input type="checkbox"/>	<input type="checkbox"/>
( )	(b) Group of persons			
	- Certified copy of partnership agreement or contract (if any) .....		<input type="checkbox"/>	<input type="checkbox"/>
	- Certified copy of identity card(s) of partners or related documents according to Item 2 (a) and (b) of each participant of the group .....		<input type="checkbox"/>	<input type="checkbox"/>
[ ]	2. Where the Bidder is a juristic person			
( )	(a) Ordinary partnership or limited partnership			
	- Certified copy of affidavit of incorporation .....		<input type="checkbox"/>	<input type="checkbox"/>
	- Name list of managing partners and list of persons entrusted with controlling power (if any) .....		<input type="checkbox"/>	<input type="checkbox"/>
	(Please fill in the form on page 10.)			
( )	(b) Limited company or public limited company			
	- Certified copy of affidavit of incorporation .....		<input type="checkbox"/>	<input type="checkbox"/>
	- Memorandum of Association .....		<input type="checkbox"/>	<input type="checkbox"/>
	- Name list of managing directors and list of persons entrusted with controlling power (if any) .....		<input type="checkbox"/>	<input type="checkbox"/>
	(Please fill in the form on page 10.)			
	- Name list of major shareholders .....		<input type="checkbox"/>	<input type="checkbox"/>
	(Please fill in the form on page 11.)			
[ ]	3. Other documents (if any)			
( )	Certified copy of any other registration required by Ministry of Commerce of Thailand .....		<input type="checkbox"/>	<input type="checkbox"/>
( )	Certified copy of registration for value added tax .....		<input type="checkbox"/>	<input type="checkbox"/>
( )	.....		<input type="checkbox"/>	<input type="checkbox"/>
( )	.....		<input type="checkbox"/>	<input type="checkbox"/>

No. of page(s)

For EGAT only

**Non-Thai National Bidder**

<p>[ ] 4. Where the Bidder is a natural person or a group of persons other than a juristic person</p> <p>( ) (a) Natural Person</p> <p style="padding-left: 20px;">- Certified copy of passport .....</p> <p>( ) (b) Group of persons</p> <p style="padding-left: 20px;">- Certified copy of partnership agreement or contract (if any) .....</p> <p style="padding-left: 20px;">- Certified copy of passport of partners or related documents according to Item 5 of each participant of the group .....</p> <p>[ ] 5. Where the Bidder is a juristic person</p> <p style="padding-left: 20px;">- Certified copy of affidavit of incorporation .....</p> <p style="padding-left: 20px;">- Name list of managing partners, directors, etc., as the case may be, and list of persons entrusted with controlling power (if any) .....</p> <p style="padding-left: 20px;">- Memorandum of Association (if any) (Please fill in the form on page 10.) .....</p> <p style="padding-left: 20px;">- Name list of major shareholders (if any) (Please fill in the form on page 11.) .....</p> <p>[ ] 6. Other documents (if any)</p> <p>( ) .....</p> <p>( ) .....</p> <p>( ) .....</p> <p>( ) .....</p> <p>( ) .....</p>	<table border="1" style="width: 100%; border-collapse: collapse;"> <thead> <tr> <th colspan="2"></th> <th style="text-align: center;">Yes</th> <th style="text-align: center;">No</th> </tr> </thead> <tbody> <tr> <td style="width: 20px;"></td> <td style="width: 20px;"></td> <td style="text-align: center;"><input type="checkbox"/></td> <td style="text-align: center;"><input type="checkbox"/></td> </tr> <tr> <td style="width: 20px;"></td> <td style="width: 20px;"></td> <td style="text-align: center;"><input type="checkbox"/></td> <td style="text-align: center;"><input type="checkbox"/></td> </tr> <tr> <td style="width: 20px;"></td> <td style="width: 20px;"></td> <td style="text-align: center;"><input type="checkbox"/></td> <td style="text-align: center;"><input type="checkbox"/></td> </tr> <tr> <td style="width: 20px;"></td> <td style="width: 20px;"></td> <td style="text-align: center;"><input type="checkbox"/></td> <td style="text-align: center;"><input type="checkbox"/></td> </tr> <tr> <td style="width: 20px;"></td> <td style="width: 20px;"></td> <td style="text-align: center;"><input type="checkbox"/></td> <td style="text-align: center;"><input type="checkbox"/></td> </tr> <tr> <td style="width: 20px;"></td> <td style="width: 20px;"></td> <td style="text-align: center;"><input type="checkbox"/></td> <td style="text-align: center;"><input type="checkbox"/></td> </tr> <tr> <td style="width: 20px;"></td> <td style="width: 20px;"></td> <td style="text-align: center;"><input type="checkbox"/></td> <td style="text-align: center;"><input type="checkbox"/></td> </tr> <tr> <td style="width: 20px;"></td> <td style="width: 20px;"></td> <td style="text-align: center;"><input type="checkbox"/></td> <td style="text-align: center;"><input type="checkbox"/></td> </tr> <tr> <td style="width: 20px;"></td> <td style="width: 20px;"></td> <td style="text-align: center;"><input type="checkbox"/></td> <td style="text-align: center;"><input type="checkbox"/></td> </tr> </tbody> </table>			Yes	No			<input type="checkbox"/>	<input type="checkbox"/>			<input type="checkbox"/>	<input type="checkbox"/>			<input type="checkbox"/>	<input type="checkbox"/>			<input type="checkbox"/>	<input type="checkbox"/>			<input type="checkbox"/>	<input type="checkbox"/>			<input type="checkbox"/>	<input type="checkbox"/>			<input type="checkbox"/>	<input type="checkbox"/>			<input type="checkbox"/>	<input type="checkbox"/>			<input type="checkbox"/>	<input type="checkbox"/>
		Yes	No																																						
		<input type="checkbox"/>	<input type="checkbox"/>																																						
		<input type="checkbox"/>	<input type="checkbox"/>																																						
		<input type="checkbox"/>	<input type="checkbox"/>																																						
		<input type="checkbox"/>	<input type="checkbox"/>																																						
		<input type="checkbox"/>	<input type="checkbox"/>																																						
		<input type="checkbox"/>	<input type="checkbox"/>																																						
		<input type="checkbox"/>	<input type="checkbox"/>																																						
		<input type="checkbox"/>	<input type="checkbox"/>																																						
		<input type="checkbox"/>	<input type="checkbox"/>																																						

**Thai and Non-Thai National Bidder**

		No. of page(s)	For EGAT only	
			Yes	No
[ ]	7. Where the Bidder is a joint venture / consortium			
	- Certified copy of association agreement	.....	<input type="checkbox"/>	<input type="checkbox"/>
( )	(a) If participant of a joint venture / consortium is not a juristic person			
	(i) Thai national			
	- Certified copy of identity card	.....	<input type="checkbox"/>	<input type="checkbox"/>
	(ii) Non-Thai national			
	- Certified copy of passport	.....	<input type="checkbox"/>	<input type="checkbox"/>
( )	(b) If participant of a joint venture / consortium is a Thai-national juristic person			
	( ) (i) Ordinary partnership or limited partnership			
	- Certified copy of affidavit of incorporation	.....	<input type="checkbox"/>	<input type="checkbox"/>
	- Name list of managing partners, and list of persons entrusted with controlling power (if any) (Please fill in the form on page 10.)	.....	<input type="checkbox"/>	<input type="checkbox"/>
	( ) (ii) Limited company or public limited company			
	- Certified copy of affidavit of incorporation	.....	<input type="checkbox"/>	<input type="checkbox"/>
	- Memorandum of Association	.....	<input type="checkbox"/>	<input type="checkbox"/>
	- Name list of managing directors, and list of persons entrusted with controlling power (if any) (Please fill in the form on page 10.)	.....	<input type="checkbox"/>	<input type="checkbox"/>
	- Name list of major shareholders (Please fill in the form on page 11.)	.....	<input type="checkbox"/>	<input type="checkbox"/>

		No. of page(s)	For EGAT only	
			Yes	No
( )	(c) If member of a joint venture / consortium is a Non-Thai national juristic person			
-	Certified copy of affidavit of incorporation	.....	<input type="checkbox"/>	<input type="checkbox"/>
-	Name list of managing partners, directors, etc., as the case may be, and list of persons entrusted with controlling power (if any) (Please fill in the form on page 10.)	.....	<input type="checkbox"/>	<input type="checkbox"/>
-	Memorandum of Association (if any)	.....	<input type="checkbox"/>	<input type="checkbox"/>
-	Name list of major shareholders (if any) (Please fill in the form on page 11.)	.....	<input type="checkbox"/>	<input type="checkbox"/>
[ ]	8. Other documents (if any)			
( )	Certified copy of any other registration required by Ministry of Commerce of Thailand	.....	<input type="checkbox"/>	<input type="checkbox"/>
( )	Certified copy of registration for value added tax in Thailand	.....	<input type="checkbox"/>	<input type="checkbox"/>
( )	.....	.....	<input type="checkbox"/>	<input type="checkbox"/>
( )	.....	.....	<input type="checkbox"/>	<input type="checkbox"/>
( )	.....	.....	<input type="checkbox"/>	<input type="checkbox"/>

We hereby confirm that all documents detailed above are true and correct.

Signed

\_\_\_\_\_  
(Name of Bidder)

stamp company seal (if any)

List of Names of Manager / Managing Partner / Managing Director / Executive /  
 Person Who Is Authorized to Manage the Business  
 (Relationship in Management)

Bidder shall fill in and submit this form with his bid

Enquiry / Bid No : ..... Enquiry / Bid Opening Date : .....

Name of Company / Partnership / Juristic Person : .....

No.	Name – Surname	Position	Name – Surname of Spouse	Name – Surname of Minor

We hereby confirm that all documents submitted are true and correct.

Signed \_\_\_\_\_  
 (Name of Bidder)

Stamp company seal (if any)

Remarks

1. The unused wordings shall be struck out.
2. Duplicate this page as necessary.

List of Partner in Ordinary Partnership / Partner with Unlimited Liability in Limited Partnership /  
Major Shareholder in Limited Company or Public Limited Company  
(Relationship in Capital)

Bidder shall fill in and submit this form with his bid

Enquiry / Bid No. : ..... Enquiry / Bid Opening Date : .....

Name of Company / Partnership / Juristic Person : .....

Registered Capital : (currency)..... Number of Share : ..... Price per Share : (currency).....

No.	Name - Surname	Position	Number of Share (%) or Amount of Shareholder's Equity	Name – Surname of Spouse	Number of Share (%) or Amount of Shareholder's Equity	Name – Surname of Minor	Number of Share (%) or Amount of Shareholder's Equity

We hereby confirm that all documents submitted are true and correct.

Signed \_\_\_\_\_

(Name of Bidder)

Stamp company seal (if any)

Remarks

1. The unused wordings shall be struck out.
2. "Major Shareholder" means a shareholder who holds more than twenty-five (25) per cent of stake in an enterprise. The shareholding of spouse or minor of a person shall be regarded as being the shareholding of such person. In case of no major shareholder, please specify "No major shareholder" in the tabulation above.
3. Duplicate this page as necessary.
4. The Bidder shall submit List of Names of Manager/ Managing Partner/ Managing Director/ Executive/ Person Who Is Authorized to Manage the Business (Relationship in Management)/ and List of Partner in Ordinary Partnership/ Partner with Unlimited Liability in Limited Partnership/ Major Shareholder in Limited Company or Public Limited Company (Relationship in Capital) of the Bidder as per page 10-11 of this Additional Regulation.

**Important Information**  
**for**  
**Invitation to Bid No. LPLC-TX-01**

---

The purpose of this section is to inform the Bidders to **carefully study** the details of the revised terms and conditions in the bidding documents. The following provisions have been **recently revised** as stated hereunder:

**Article A-2. Eligibility of Bidders: General Requirements**

According to the Notification of the Anti-Corruption Co-operation Committee Concerning Minimum Standards of the Policy and Directions for Anti-Corruption in Relation to Procurement Required to be put in place by the Business Operator, in accordance with Section 19 of the Public Procurement and Supplies Administration Act, B.E. 2560 (A.D. 2017), the article has been revised as per Data Sheet.

**Article A-5. Preparation and Delivery of Bids and Article B-1. Preparation of Bids**

Details on how to prepare the proposal have been revised. Bids shall be prepared in accordance with the Instructions to Bidders contained in the Bidding Documents in one (1) original hard copy and one (1) electronic copy contained in USB flash drive.

**Article A-5. Preparation and Delivery of Bids**

Details of bid opening time and place shall be specified in the Tentative Schedule.

**Article A-6. Availability of Bidding Documents**

Availability of Bidding Documents has been changed from CD-ROM to electronic files for download via link provided by EGAT.

**Channel of Documents Submission**

For channel of document submission in the hereunder Articles, facsimile and telex has been replaced with letters submitted electronically or electronic mails (E-mails).

- Article B-1. Preparation of Bids
- Article B-4. Validity of Bids
- Article D-9. Notices
- Article E-17. Documents Required for Each Shipment
- Article F-8. Payment

## **Article B-2. Bid Prices**

For Source of Supply and Service b., Prices for Equipment manufactured outside Thailand (imported Equipment) shall be firm, stated both on FOB Port of Shipment/Vessel and CFR Thai Port basis, and quoted in Thai baht, US dollar, euro, Japanese yen, renminbi (Chinese yuan), or in the Bidder's or Manufacturer's home currency only if his currency trading is prevailed at the time of bidding in any international market other than in Bidder's or Manufacturer's home country.

The following paragraph has also been added :-

“Prices for the following Equipment manufactured outside Thailand which was imported before the bid opening date shall be firm ex-works and quoted in Thai baht, provided that the Bidder shall submit any document(s) evidencing the importation date of such Equipment:

- Power Fuse
- Stationary Battery and Battery Charger
- Insulator for substation
- Cable Termination
- Compression Connector and Miscellaneous Hardware
- Bus Fittings
- Grounding Material
- Substation Miscellaneous”

## **Article B-8. Information to be Submitted with Bid**

According to the Notification of the Anti-Corruption Co-operation Committee Concerning Minimum Standards of the Policy and Directions for Anti-Corruption in Relation to Procurement Required to be put in place by the Business Operator, in accordance with Section 19 of the Public Procurement and Supplies Administration Act, B.E. 2560 (A.D. 2017), the article has been revised as per Data Sheet.

## **Article E-14. Preparation for Delivery**

The Instructions for Packaging attached at the end of Section E. General Conditions has been revised in item 8. Shunt Capacitor Bank.

## **Article E-16. Shipment**

The Maritime Promotion Bureau has been updated to the Maritime Promotion Division and its contact information has also been updated.

**Article F-8. Payment**

After each payment is made, the Contractor or beneficiary shall issue and submit the receipt to EGAT as detailed in the paragraph added at the end of this article.

According to the Notification of the Anti-Corruption Co-operation Committee Concerning Minimum Standards of the Policy and Directions for Anti-Corruption in Relation to Procurement Required to be put in place by the Business Operator, in accordance with Section 19 of the Public Procurement and Supplies Administration Act, B.E. 2560 (A.D. 2017), the article has been revised as per Data Sheet.

DRAFT

DRAFT

DATA SHEET

# DATA SHEET

for

## Invitation to Bid No. LPLC-TX-01

---

This section consists of provisions that are specific to each procurement and supplement the information or requirements included in bidding documents.

### **Article A-2. Eligibility of Bidders: General Requirements**

The following requirement shall be added to this Article:

- m. Bidders shall provide written minimum standards of the policy and directions for anti-corruption in relation to procurement together with supporting evidence pursuant to the Notification of the Anti-Corruption Co-operation Committee Concerning Minimum Standards of the Policy and Directions for Anti-Corruption in Relation to Procurement Required to be put in place by the Business Operator, in accordance with Section 19 of the Public Procurement and Supplies Administration Act, B.E. 2560 (A.D. 2017).*

### **Article B-3. Bid Security**

The amount of bid security shall be USD 642,270.- or THB 20,900,000.-.

### **Article B-4. Validity of Bids**

The validity of the bid shall be for one hundred and fifty (150) Days from the date specified for opening of bid.

### **Article B-8. Information to be Submitted with Bid**

For supply of 500 kV Autotransformer,

- m. A statement indicating that the parent manufacturer shall certify and be responsible for the design, production process and quality control.

The following document shall be added to this Article:

- n. Bidder's minimum standards of the policy and directions for anti-corruption in relation to procurement, together with the completely filled out Anti-Corruption Compliance Checklist as provided, and supporting evidence.*

*Where the Bidder holding a certification under ISO 37001 Anti-Bribery Management Systems, certification from the Thai Private Sector Collective Action against Corruption (CAC Certified), or any certification as prescribed by the Anti-Corruption Co-operation Committee, shall be deemed to have satisfied the minimum standards of the policy and directions for anti-corruption in relation to procurement. Such certification documents may be submitted as part of the bid.*

*Such minimum standards of the policy and directions for anti-corruption in relation to procurement, or the certification, shall remain valid and effective from the bid opening date.*

**Article B-12. Evaluation and Comparison of Bids:**

The evaluation of bid prices shall be on schedule basis.

**Article E-29. Failure to Meet Requirements and F-10. Maintenance Guarantee**

Maintenance Guarantee Period

- For all Equipment except Shunt Reactor, 200 MVA 230 kV and above Power Transformer and 500 kV System Voltage Equipment

The Contractor shall guarantee the proper functioning of Equipment for a period of one (1) Year except the following Equipment the guarantee period of which shall be as follows :

<u>Equipment</u>	<u>Period of Guarantee (Year)</u>
- Fault Recording System	2
- Control and Protection System	2
- <u>For Shunt Reactor, 200 MVA 230 kV and above Power Transformer and 500 kV System Voltage Equipment</u>	

The Contractor shall guarantee the proper functioning of Equipment for a period of five (5) Years.

Defective Equipment to be replaced with the whole new set

For GIS, Power Transformer, Power Circuit Breaker, Shunt Reactor, in case EGAT, at its sole discretion, requires the Contractor to replace any defected Equipment, the Contractor shall replace the Equipment with the whole new set as specified in Failure to Meet Requirements in section E and Maintenance Guarantee in section F.

**Article F-8. Payment**

*The following paragraphs shall be added as the last two paragraphs of this article:*

*“ Please note that the Contractor shall provide written minimum standards of the policy and directions for anti-corruption in relation to procurement or a certification of anti-corruption standards that are valid until the date of receipt of the final payment under the Contract.*

*In the case where EGAT finds that the validity period of the Contractor's submitted minimum standards of the policy and directions for anti-corruption in relation to procurement, or the relevant certification, will expire before the date of receipt of the final payment under the Contract, EGAT shall issue a written notification to the Contractor requiring the submission of a revised or updated, completely filled out Anti-Corruption Compliance Checklist together with supporting evidence, prior to the expiration date of the existing Anti-Corruption Compliance Checklist. ”*

**Article F-9. Liquidated Damages for Late Delivery of Equipment**

The Liquidated Damages shall be at the rate of one-tenth of one (0.10) per cent of the price of each complete item of Equipment not timely delivered for each Day of delay. This sum is payable regardless of the actual loss and/or damages incurred.

DRAFT

**SECTION A**  
**INVITATION TO BID**

**INVITATION TO BID NO. LPLC-TX-01**  
**SUPPLY OF 333.33 MVA 500 kV POWER TRANSFORMER**  
**LONG-TERM INVESTMENT PLAN**  
**TO ACCOMMODATE LARGE POWER CONSUMER**

---

**A-1. Invitation**

The Electricity Generating Authority of Thailand (EGAT) hereby invites sealed bids for furnishing and delivering of 333.33 MVA 500 kV Power Transformer under Long-Term Investment Plan to Accommodate Large Power Consumer hereinafter called Equipment in accordance with the terms, conditions and Specifications described in these Bidding Documents.

**A-2. Eligibility of Bidders: General Requirements**

All Bidders shall meet the following requirements; failure to so comply shall constitute sufficient ground for rejection.

- a. The Bidder shall be a partnership, firm or company, either alone or in joint venture or in consortium.
- b. The Bidder must have purchased the bidding documents from EGAT. For a joint venture or a consortium, only one (1) member of the joint venture or consortium is required to purchase the bidding documents.

In case the Bidder's name is not exactly the same as the purchaser's name, the purchaser shall notify EGAT of the name of the Bidder in writing prior to the bid opening time.

- c. The Bidder shall be well-established and maintain a permanent place of business. For a joint venture or consortium, all members of the joint venture or consortium are required to meet this qualification.
- d. The Bidder shall not be named in the List of Work Abandoners published by the Permanent Secretary, Ministry of Finance, and/or in the Debarment List and/or in the List of Work Abandoners declared by EGAT.

- e. For the Bidder who changes name before submitting the bid, his experience records in previous name shall be considered as the experience records of the Bidder.
- f. The Bidder shall not be a Jointly Interested Bidder with other Bidders as from the date of EGAT's issuance of this invitation to bid, or shall not be a person who undertakes any action as an "Obstruction of Fair Price Competition" as defined in Additional Regulation for this invitation.
- g. The Bidder shall not either be EGAT's consultant or involve in EGAT's consultancy company under this invitation, or have EGAT's personnel involved in his business as shareholder having voting right that can control his business, director, manager, officer, employee, agent or consultant except the ones who are officially ordered by EGAT to act or participate therein.
- h. The Bidder shall not be the person who is privileged or protected not to be taken any legal proceeding under Thai court; provided that such Bidder's government declares that such special privilege is waived.
- i. In case of a joint venture or consortium, the Bidder shall carry out all the provision of the Equipment and all Work under such formation from the time of bidding until the fulfillment of the Contract and the parties to the joint venture or the consortium shall accept joint and several liability for performing all obligations under the bid and the Contract.
- j. The Bidder shall not propose to supply the Equipment from the country under the state of war whether declared or not.
- k. The Bidder shall have adequate fund to meet financial obligations incidental to this Contract.
- l. The Bidder shall submit documentary evidence established in accordance with Article B-8. Information to be Submitted with Bid to demonstrate the Bidder's sufficient eligibility to bid and qualification to perform the Contract.

**A-3. Eligibility of Bidders: Technical Requirements**

- I. All Bidders shall meet the following requirements; failure to so comply shall constitute sufficient ground for rejection.**
  - a. The Bidder shall manufacture or supply the Equipment or Work as required under this invitation to bid.

- b. If the Bidder is a new company formed by acquisition of or merger with other companies or business units before submitting the Bid, the experience records of any of such previous companies or business units that meet the requirements set forth herein are acceptable as the experience records of the Bidder.
- c. The Bidder shall have no just or proper claims pending against the Bidder with respect to breach in the performance of contract on other similar works awarded by EGAT. If the Bidder is a new company formed by acquisition of or merger with other companies or business units, the pending claim of any of such previous companies or business units shall be considered pending claim of the Bidder.
- d. The Bidder shall have sufficient capacity to carry out the Work.
- e. The Bidder shall propose Equipment manufactured by the qualified manufacturers who shall fulfill the following requirements :
  1. Being well-established and maintaining a permanent place of business.
  2. The manufacturer shall have the experience records that meet the requirements set forth herein.

Reference records of either parent or affiliated companies shall not be considered as the records of such manufacturer.

3. If the Manufacturer is a new company formed by acquisition of or merger with other companies or business units, and any of such previous companies or business units has the experience records that meet the requirements set forth herein, such experience records are acceptable as the experience records of the new company, provided that each item of the equipment to be supplied under this bid shall be manufactured from the same source of supply as indicated in each of such relevant supply records as described in Item *e.5* thru. *e.6* below. Otherwise, it shall not be acceptable and shall be sufficient grounds for rejection.

For the avoidance of doubt, it is not allowed to combine the experience records of the previous companies or business units in order to meet the experience requirements.

4. Regularly manufacturing of transformers of the type specified.
5. Having one of the following qualifications:
  - 5.1 Having experience in manufacturing of at least six (6) units of auto-transformers having the minimum capacity of 333.33 MVA (single phase) and minimum BIL rating of 1425 kV with at least five (5) consecutive years of successful operation/use in an overseas country (not his own country)

OR

5.2 Having experience in manufacturing of at least two (2) units of auto-transformers having the minimum capacity of 1000 MVA (three phase) and minimum BIL rating of 1425 kV with at least five (5) consecutive years of successful operation/use in an overseas country (not his own country)

OR

5.3 Having experience in manufacturing of a combination of at least three (3) units of the single-phase auto-transformers of item 5.1 and at least one (1) unit of the three-phase auto-transformers of item 5.2 with at least five (5) consecutive years of successful operation/use in an overseas country (not his own country).

OR

5.4 Having experience in manufacturing of at least three (3) units of auto-transformers having the minimum capacity of 333.33 MVA (single phase) and minimum BIL rating of 1425 kV with at least one (1) year of successful operation/use in EGAT System.

OR

5.5 Local manufacturer, having a letter of acceptance issued by EGAT for manufacturing and/or fabrication of 500 kV auto-transformer with rating of not-more-than 333.33 MVA is allowed to propose only one (1) schedule with the maximum number of 7 units. Otherwise, EGAT reserves the right to reject such bid as being non-responsive.

Furthermore, the local manufacturer who is awarded and signs the Contract with EGAT shall be allowed to participate in the next bid after it is certified by EGAT that at least three (3) units of transformers provided under the Contract have at least one (1) year successful operation in EGAT system, with a certification letter issued by EGAT.

6. Having one of the following qualifications:

6.1 Having a short circuit test record of the auto-transformer of 200 MVA, 230 kV or above. The level of occurring stress in the winding shall be similar to the proposed unit. The short circuit test record shall be *performed at* international reference laboratory/ institute/ utility as *follows: KEMA, EDF, CESI and IREQ.*

OR

6.2 Having a record of satisfactory operation/use of the auto-transformer of at least 200 MVA, 230 kV or above in EGAT system. The minimum supplying record shall be two (2) units with five (5) consecutive years of operation/use.

OR

6.3 Having a letter of acceptance for manufacturing and/or fabrication of the specific Equipment issued by EGAT within the scope specified therein (For the local manufacturer).

7. Proposing the manufacturer who has no just or proper pending claims against Equipment on other similar works.

In case the manufacturer is a new company formed by acquisition or merger with other companies or business units, the pending claim of any of such previous companies or business units shall be considered pending claim of the manufacturer.

8. In addition, Bidder may proposed the Equipment of the qualified manufacturer under clause *e.1* thru *e.7* which manufactured by another factory (not an original factory) for consideration on the conditions that :

8.1 The manufacturer shall have the experience records that meet the requirements set forth herein.

Reference records of either parent or affiliated companies shall not be considered as the records of such manufacturer.

8.2 If such proposed factory is a new company formed by acquisition of or merger with other companies or business units, and any of such previous companies or business units has the experience records that meet the requirements set forth herein, such experience records are acceptable as the experience records of the new company, provided that each item of the equipment to be supplied under this bid shall be manufactured from the same source of supply as indicated in each of such relevant supply records as described in Item *e.8.3*. Otherwise, it shall not be acceptable and shall be sufficient grounds for rejection.

For the avoidance of doubt, it is not allowed to combine the experience records of the previous companies or business units in order to meet the experience requirements.

8.3 Such proposed factory shall have experience in manufacturing of :

a. at least six (6) units of auto-transformers having the minimum capacity of 250 MVA (single phase) and minimum BIL rating of 1425 kV with at least three (3) years of successful operation/use.

OR

b. at least two (2) units of auto-transformers having the minimum capacity of 750 MVA (three phase) and minimum BIL rating of 1425 kV with at least three (3) years of successful operation/use.

OR

- c. a combination of at least three (3) units of the single-phase auto-transformers of item a. and at least one (1) unit of the three-phase auto-transformers of item b. with at least three (3) years of successful operation/use.

8.4 Proposing such factory who has no just or proper pending claims against Equipment on other similar works.

In case such factory is a new company formed by acquisition or merger with other companies or business units, the pending claim of any of such previous companies or business units shall be considered pending claim of such factory.

**II. All Bidders should preferably meet the following technical requirements; failure to so comply may constitute sufficient ground for rejection.**

- a. Proposing the Equipment from the manufacturer having a certificate indicating that his system has been satisfactorily developed and implemented conforming to ISO 9001.

**A-4. Joint Venture or Consortium**

In the event that the successful Bidder is a joint venture or a consortium formed of two or more companies, EGAT requires that the parties to the joint venture or the consortium accept joint and several liability for all obligations under the Contract.

**A-5. Preparation and Delivery of Bids**

Bids shall be prepared in accordance with the Instructions to Bidders contained in the Bidding Documents in one (1) original *hard copy and one (1) electronic copy contained in USB flash drive*, in English, on the bid forms included for this purpose and shall be accompanied with a bid security as required under Article B-3. Bid Security in a separate sealed envelope.

*For preparation of original hard copy, each page of the original hard copy shall be marked with the volume number and the page number in the lower right-hand corner, for example, Volume 1 of 10 and Page 1 of 100.*

*For preparation of electronic copy, each volume of the signed original hard copy shall be scanned into one (1) PDF file and each PDF file shall be named according to the volume number.*

*The USB flash drive shall contain electronic files of the proposal in the following formats :-*

- PDF files of all pages of each volume of the proposal, and*
- Excel files of filled-in Proposal Data, and*
- Excel files of filled-in Price Schedule*

*In the event of any discrepancy between the original hard copy and the electronic file(s), the original hard copy shall govern.*

The envelope of the bids will be marked in capital letters in the lower left-hand corner as follows :

**INVITATION TO BID NO. LPLC-TX-01**  
**SUPPLY OF 333.33 MVA 500 kV POWER TRANSFORMER**  
**LONG-TERM INVESTMENT PLAN**  
**TO ACCOMMODATE LARGE POWER CONSUMER**

and shall be addressed and delivered to **EGAT**, on or before 10:00 a.m., Bangkok Standard Time, .....*see Tentative Schedule*.....

If the envelope(s) is not sealed, marked and addressed as required above, EGAT will assume no responsibility for the bid misplacement or premature opening.

Bids will be opened publicly at the *place and* time specified *in Tentative Schedule.*

Bids received after the time stipulated herein shall be rejected and returned unopened.

**A-6. Availability of Bidding Documents**

The Bidding Documents are available for examination *and online purchase at <http://www4.egat.co.th/fprocurement/biddingeng/>* and can be obtained *by downloading via link provided by EGAT* upon payment to EGAT, non-refundable, in the amount of USD 170.- or Baht 5,000.-. These prices include the value added tax.

DRAFT

**SECTION B**  
**INSTRUCTIONS TO BIDDERS**

## INSTRUCTIONS TO BIDDERS

### Overview of the Procurement Process

Bid prices and the Contract Price shall include value added tax (VAT) imposed under the law of Thailand. The medium cost announced by EGAT is inclusive of VAT and other relevant expenses.

The amounts of performance security, maintenance security, and liquidated damages shall also be based on the Contract Price which is inclusive of VAT (if any).

For evaluation and comparison of Bids, the bid price shall be evaluated according to the conditions specified in the bidding document.

The procurement process is summarized in the following diagram.

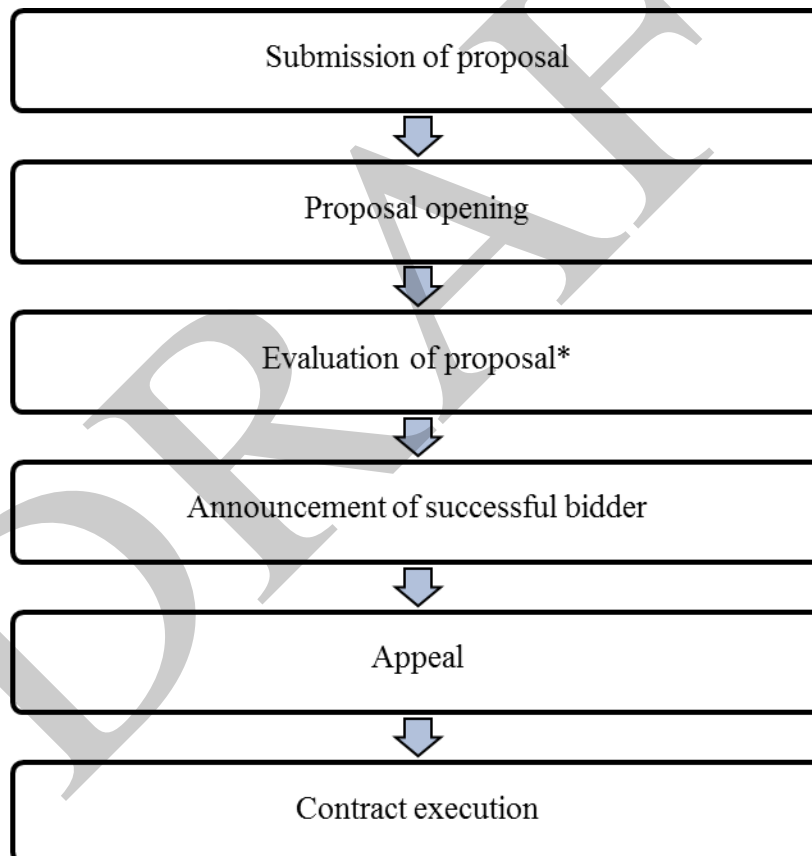

#### \*Remarks

1. The Bidder shall be deemed to have carefully examined all of the terms, conditions and Specifications of the Bidding Documents.
2. EGAT will take into consideration the conformity of the bid to the requirements of the Bidding Documents as well as the suitability for the purpose intended.
3. EGAT will not be bound to accept the bid with the lowest indicated cost. EGAT reserves the right to accept the bid which in its judgement is the lowest evaluated bid.

## **B-1. Preparation of Bids**

- a. Bids shall be prepared in English, in one (1) original *hard copy clearly marked “Original” and one (1) electronic copy contained in USB flash drive*, submitted at the place and time specified for receipt of bids.

In the event of any discrepancy between *the original hard copy and the electronic copy, the original hard copy* shall govern.

*For Proposal Data, Bidder shall fill in information of Proposal Data in Excel files contained in the Bidding Documents, and submit one (1) original hard copy with the PDF and Excel files in USB flash drive to EGAT at the same time of bid submission.*

For price quotation, Bidder *shall fill in* bid prices in an Excel files of Price Schedules contained in the Bidding Documents in accordance with Price Quotation Instructions in Section C, Part 1: Price Proposal, and submit one (1) original *hard copy with the PDF and Excel files in USB flash drive* to EGAT at the same time of bid submission.

VAT at the prevailing rate shall be filled automatically in the Summary of Bid Price of the price schedule in the Excel file subject to Article B-2. Bid Prices.

However, in case Bidder is a consortium formed of two or more companies, Bidder must also submit one (1) original hard copy *with the PDF and Excel files* of price schedules of the Work performed by each member of the consortium in addition to hard copies *with the PDF and Excel files* of the total bid price as specified above.

If any discrepancy between the bid prices of the Work performed by each member of the consortium and the bid prices of the Bidder occurs, the bid prices of the Bidder shall govern and the bid prices of the Work performed by each member of the consortium shall be adjusted accordingly.

In the event of discrepancy between the original hard copy *and the PDF or Excel files* submitted, the original hard copy shall govern.

- b. Bidder shall not submit more than two (2) proposals and the proposal(s) to be submitted shall conform to the specifications. In case of any deviation from the specifications, Bidder shall follow the provisions under Article B-9. Deviations from Specifications.
- c. The "Original" shall be prepared on the bid forms included and made a part of the Bidding Documents, which shall be submitted with all applicable blanks in the bid forms properly filled in, and shall be manually signed in ink by a person or

persons duly authorized. The letter of authorization shall be indicated by written power-of-attorney accompanying the bid.

All pages of the bid, except for unamended printed literature, shall be initialled by the person or persons signing the bid.

- d. The bid shall contain no interlineations, erasures or overwriting except as necessary to correct errors made by the Bidder, in which case such corrections shall be initialled by the person or persons signing the bid.
- e. Modification by letter or *by letter submitted electronically or by electronic mail (E-mail)* to bids already submitted will be considered if received prior to the time fixed for the receipt of bids. Confirmation by letter of any modification *evidenced* by post mark or by *letter submitted electronically or by electronic mail (E-mail)* should be sent to EGAT not later than the deadline for submission of Bids.
- f. No Bidder will be permitted to alter his bid after the bids have been opened, but clarifications not changing the substance of the bid therein may be accepted.
- g. Bidder may quote for any schedule or all schedules as called for, but shall quote for all items of the schedule(s) proposed. Consideration will be made as stipulated in Article B-12. Evaluation and Comparison of Bids.
- h. Any price discount to be offered shall be clearly stated in the Discount Form accompanied with the Bid to be submitted on the bid opening date specified herein.

## **B-2. Bid Prices**

### Currency

Bid prices as shown in Article C-1. Price Schedule shall be firm, not subject to adjustment and payable in the currencies as follows :

- a. The bid price shall be quoted in Thai baht, US dollar, euro, Japanese yen, renminbi (Chinese yuan), or in the Bidder's or Manufacturer's home currency only if his currency trading is prevailed at the time of bidding in any international market other than in Bidder's or Manufacturer's home country.

If the currencies quoted by the Bidder do not conform to the requirement set forth herein, EGAT reserves the right to convert the bid price to US dollars by using the exchange rate on the Bloomberg screen which is announced at 10.00 a.m. (Bangkok Time) on the bid opening date. Such converted bid price in US dollars shall be treated as the Bidder's proposed bid price. In such case the Contract Price for such portion under the Contract shall be made in US dollars.

Subject to paragraph a. above, in case the Bidder expects to incur a portion of its expenditures in the performance of the Contract in more than one currency and wishes to be paid accordingly, the bid price shall be expressed in different currencies and the respective amount in each currency together making up the total price.

- b. Local expenditures shall be quoted in Thai Baht.
- c. Payments will be made in the currency or currencies in which the bid prices have been stated.

#### Source of Supply and Service

- a. Prices for Equipment manufactured in Thailand shall be firm ex-works prices and quoted in Thai Baht. Any import duty and taxes (value added tax included) assessed by the Government of Thailand at the port of entry on imported raw materials or components shall be paid by the Contractor and included in these ex-works prices.
- b. Prices for Equipment manufactured outside Thailand (imported Equipment) shall be firm, stated both on FOB Port of Shipment/Vessel and CFR Thai Port basis, and quoted in currencies specified above. Any import duty, excise tax (if any) and value added tax to be assessed by the Government of Thailand at the port of entry shall not be included in the quoted bid prices.

***Prices for the following Equipment manufactured outside Thailand which was imported before the bid opening date shall be firm ex-works and quoted in Thai baht, provided that the Bidder shall submit any document(s) evidencing the importation date of such Equipment:***

- ***Power Fuse***
- ***Stationary Battery and Battery Charger***
- ***Insulator for substation***
- ***Cable Termination***
- ***Compression Connector and Miscellaneous Hardware***
- ***Bus Fittings***
- ***Grounding Material***
- ***Substation Miscellaneous***

- c. Prices for services including cost of installation supervisor (if any) shall be firm.
- d. All expenses incurred for the Work specified in Article F-1. Scope of Work shall be included in the quoted Bid Prices.

### Price Schedule

The Bidder shall enter a unit price, an amount, or a lump sum price, as required, for every item listed in the price schedule. If the unit price as entered does not conform to the amount entered for the same item, the unit price shall govern. If the sum of the amount entered for individual items does not conform to the total amount entered for these amounts under total bid prices, then the sum of the amount entered for the individual items shall govern.

Where quantity and total price only are required, the unit price shall be taken as the stated total price divided by the quantity specified.

Except for foreign supply, VAT at the prevailing rate shall be filled automatically in the Summary of Bid Price of the price schedule in the Excel file. However, the Contract Price shall include VAT only for the portion of Work which is subject to VAT.

### **B-3. Bid Security**

The original of the bid submitted shall be accompanied with a bid security in the form of a cash deposit, or a cashier cheque issued by a local bank, or a bank guarantee or a letter of guarantee issued only by a local bank or an acceptable financial institution in Thailand, or by a foreign bank counter-guaranteed by a local bank as primary obligor. In case of a cash deposit or a cashier cheque, only Thai baht can be made.

The bid security shall be in a form as per specimen attached or in any other form with essential content in accordance with the specimen, and made payable to EGAT in the amount as specified in Data Sheet. Any bid not being accompanied with bid security shall be rejected. The bid security shall remain in force up to and including ninety (90) Days after the expiry date of the bid validity.

The bid security shall be forfeited in favor of EGAT if :

- a. The Bidder withdraws his bid after the bid is opened; or
- b. The successful Bidder fails for any reason to execute the Contract or to furnish a performance security.

The Bidder may, upon EGAT's request to extend the bid security when it has expired, refuse to do so without forfeiting the bid security. A Bidder granting the request will be neither required nor permitted to modify his bids.

The bid security of unsuccessful Bidder(s) will be returned as decided by EGAT or within thirty (30) Days following EGAT's acceptance of the successful Bidder.

The bid security of the successful Bidder will be returned upon execution of the Contract and after the performance security furnished has been accepted by EGAT.

**B-4. Validity of Bids**

The validity of the bid shall be as specified in Data Sheet.

In the event EGAT requires the validity period to be extended, EGAT may in writing or by *letter submitted electronically or by electronic mail (E-mail)* so notify the Bidders at least fourteen (14) Days prior to the expiry date of the validity period, in which event any Bidder not agreeing to such request for extension may withdraw his bid by so advising EGAT in writing or by *letter submitted electronically or by electronic mail (E-mail)* prior to the expiry date of the original validity period. If the advice of withdrawal shall not have been received by EGAT prior to the said date, the extension shall be deemed to have been accepted by the Bidder, and the Bidder shall be required to extend the effective period of the bid security accordingly.

**B-5. Delivery of Bids**

Where bids are submitted by mail, the hour and date of receipt of the bid will be taken as that certified by EGAT. For all bids delivered directly, a receipt will be furnished to the Bidder indicating the place, hour, and date of delivery. Late bids will be returned unopened.

**B-6. Withdrawal of Bids**

Bids may be withdrawn only on written requests which are received by EGAT prior to the time fixed for the receipt of the bids. Negligence on the part of the Bidder in preparing his bid confers no right for the withdrawal of the bid after it has been opened. Whenever a bid has been withdrawn, it will be returned unopened to the Bidder.

**B-7. Interpretation of Bidding Documents before Bid Opening**

If a prospective Bidder is in doubt about the true meaning of any part of the Bidding Documents, the Bidder may submit to EGAT a written request for a reply or an interpretation; provided that sufficient time is allowed for a reply to reach the prospective Bidder prior to the date specified for bid opening. An interpretation will be given in the form of a Supplemental Notice furnished to all prospective Bidders. Receipt of all Supplemental Notices shall be acknowledged by each prospective Bidder on the Proposal. Oral interpretation of the Bidding Documents will not be binding.

**B-8. Information to be Submitted with Bid**

Each Bidder shall submit with his bid the following documents, data and information in English language in addition to any other information called for elsewhere in the Bidding Documents in order to enable EGAT to fully evaluate the Proposal of the Bidder :

- a. Name of manufacturer and country of origin and type or model of Equipment he proposes to furnish.
- b. Data, drawings, catalogue and descriptive materials which will show equipment arrangement, general dimensions, principles of operation, extent of factory assembly, and the materials from which parts are made.
- c. Sufficient references describing the technical experience of the manufacturers, including lists of the Equipment supplied and installed overseas. If possible, certificates issued by the user and/or consulting engineers supporting the said work and record of commercial operation in good condition should also be submitted.
- d. Copies of Auditor's certified balance sheet of the Bidder for the past three (3) consecutive years.
- e. In case the local manufactured Equipment is proposed, the sufficient documentary evidence, if any, showing that the manufacturers have been acknowledged for producing standard product by the Thai Industrial Standard Institute (TISI), Ministry of Industry, or registered with TISI, or ISO 9000 certified by the National Accreditation Council of Thailand (NAC) or obtained the privilege from the Board of Investment or accepted by EGAT for manufacture of such Equipment, is required to be submitted with the Bid.
- f. Sufficient evidence documents clearly demonstrating that a firm/company who changes its name, merges with, or acquires other company/companies, or forms a new company by merging its business unit with those of other companies, and the experience records of the new company clearly demonstrating that it has sufficient evidence of running the business as before.
- g. A statement of proposed minor deviations from the Specifications along with complete specifications and all necessary descriptive literature for any proposed alternative Equipment or procedure, as required under Article B-9. Deviations from Specifications.
- h. Where Proposal Data Forms are provided, the Bidder shall enter all information as directed.

- i. Where the Specifications provide for submission of a sample or samples, the Bidder shall submit same together with his bid.
- j. Joint Venture/Consortium Agreement with a statement that each member of a joint venture/consortium will be jointly and severally responsible and liable for the complete execution of the work (in case the Bidder is a joint venture or consortium).
- k. Confirmation Form of not being a Jointly Interested Bidder with other Bidders and not being a person who undertakes any actions as an Obstruction of Fair Price Competition, and Registration/Non-registration with the Revenue Department as a VAT registrant.

If the Bidder has registered as a VAT registrant, he shall submit EGAT an evidence of VAT registration. On the contrary, if the Bidder is not registered as a VAT registrant, he shall inform EGAT whether he will register as a VAT registrant or not.

In case the Bidder is a consortium, each member of the consortium shall fill in the Confirmation Form provided for consortium Bidders.

- l. Filled-in Documentary List and documents required according to Additional Regulation.
- m. A statement indicating that the parent manufacturer shall certify and be responsible for the design, production process and quality control. This information is required only for the Equipment specified in Data Sheet.

Should the Bidder fail to submit any of the document described above and neglect to submit the same to EGAT within the time as specified by EGAT, such failure shall be sufficient reason for rejection of his bid.

Verbal statements made by the Bidder at any time regarding quality, quantity, or arrangement of Equipment will not be considered.

If alternative Equipment is indicated in the bid, it shall be understood that EGAT will have the option of selecting any one of the alternates so indicated and such selection shall not be a cause for extra compensation or extension of time.

In case the Bidder proposes alternative Equipment, with the condition to supply any one of the alternates so indicated at his option, such bid will be considered conditional and may be considered sufficient reasons for rejection.

**B-9. Deviations from Specifications**

Unless otherwise provided in the Specifications, the quality of Equipment and workmanship shall comply in all respects with the Standards required under the bidding documents.

If the Bidder proposes any minor deviations from the specifications, he shall submit a statement of each proposed deviation referenced to the particular Article of these specifications, details on the design drawings or article, paragraph and section of referenced standards or specifications. Full details of all minor deviations together with confirmation shall be submitted with the bid in a form provided in Section C. The Bidder shall submit, with his bid, copies of the standards or specifications proposed for his deviations. In case there is no statement in the form provided in Section C in the Bidder's proposal on the proposed deviations, the bid shall be regarded by EGAT as conforming in all respects to the terms and conditions and Specifications as stated in the bidding documents at no additional cost to the bid price.

Notwithstanding the foregoing, it is at EGAT's sole discretion in determining whether any of such proposed deviations is acceptable and in determining whether it is minor or major deviation.

**B-10. Rejection of Bids**

EGAT reserves the right not to accept the lowest evaluated bid.

Bids shall be strictly based on the Specifications and terms and conditions in the Bidding Documents. Should any bid fail to comply with the terms and conditions stipulated in these Bidding Documents, especially those under Article pertaining to payment or be incomplete, conditional or obscure, or contain additions not called for, or irregularities of any kind, it will be liable to rejection.

EGAT also reserves the right to reject any or all bids submitted without giving reason or to reject the bid from any Bidder who fails to satisfy EGAT that the bid complies with the terms and conditions stipulated in these bidding documents without any non-compliance which is deemed substantial and advantageous over other Bidders.

**B-11. Delivery Time**

Delivery time required is indicated for each respective Price Schedule in the Proposal section of the Bidding Documents, and shall be carefully observed. However, no preference will be given in the bid evaluation for earlier delivery than the stipulated delivery period.

All bids specifying delivery time later than those indicated may be rejected.

## **B-12. Evaluation and Comparison of Bids**

Bid prices pursuant to Article B-2. Bid Prices will be evaluated as follows :

1. The evaluation of bid prices shall be specified in Data Sheet.
2. Bid prices will be converted into Thai Baht at the selling exchange rates, published by the Bank of Thailand, www.bot.or.th between Baht and other currencies on the bid opening date.
3. The rate of import duty prevailed on the bid opening date will be used for the purpose of bid evaluation of CFR Thai Port Price.
4. The prices to be used for evaluation and comparison purpose shall be as follows :
  1. Ex-works price including VAT for the final sale direct to EGAT for locally manufactured Equipment
  2. CFR Thai Port of Equipment to be imported plus the calculated insurance premium of 0.072% of [CFR price+10% (CFR price)], import duty, excise tax (if any), value added tax to be assessed by the Thai Government at the port of entry for imported Equipment , and 0.6 % of CFR price for customs clearance

The rate of import duty to be used for price comparison shall be as follows:

- a) For Equipment consisting of separate components which are intended to contribute together as a functional unit and imported under partial import entry - using a normal single tariff rate published in the Customs Tariff Decree for such Equipment
- b) For other Equipment and spare parts
  - i) In case any imported Equipment and spare part is proposed from one (1) country of origin for the same item:
    - Country of Origin Under Free Trade Agreement (FTA) – using lower comparing rate between the FTA rate and the normal rate published in the Customs Tariff Decree;
    - Country of Origin Under Non FTA – using a normal rate published in the Customs Tariff Decree.
  - ii) In case any imported Equipment and spare part is proposed from different countries of origin for the same item, a normal rate published in the Customs Tariff Decree for such Equipment and spare part will be used for price comparison.

3. Cost of local transportation including VAT, if any
4. Cost of installation supervisor including VAT, if any
5. Guaranteed losses of Equipment, if any, at the rate as stipulated in the Proposal Data.

Price for optional items, if any, will not be taken into consideration; however, Bidders shall also quote the prices thereof as required.

**B-13. Acceptance of Bids**

EGAT will not be bound to accept the bid with the lowest indicated cost. EGAT reserves the right to accept the bid which in its judgement is the lowest evaluated bid. In making its selection, EGAT will take into consideration the conformity of the bid to the requirements of the Bidding Documents and Specifications, guaranteed delivery time, the suitability for the purpose intended and whenever applicable, compensating factors will be applied to deviation or departures from Specifications. EGAT will also take into consideration whether the Bidder's experience, organization, facilities and financial resources will assure the successful carrying out of the Work under the Contract within the time specified.

**B-14. Appeal**

Disqualified or unsuccessful Bidders who see that their disqualification or failure are due to EGAT's non-compliance with EGAT's procurement regulations may appeal to EGAT within fifteen (15) Days from the date of receipt or announcement, whichever comes first, of EGAT's final evaluation result. An appeal shall be made in writing and clearly state the cause of appeal and argument with referred facts or regulations and related documents. Appealing does not constitute a ground for suspending the ongoing procurement process unless EGAT's Governor agrees otherwise.

The Contract or Purchase Order shall not be executed until the period of appeal has ended and there is no appeal. In the event there is an appeal during such period, the Contract or Purchase Order shall not be executed unless EGAT's Governor concurs.

Decision of EGAT's Governor is final and conclusive.

**B-15. Award of Contract**

The Contract will be awarded as soon as practicable after opening of the bids, to the Bidder with the lowest evaluated bid. EGAT reserves the right to award the Contract on the basis of standards and specifications as proposed by the Bidder, if in the opinion of EGAT, they are considered acceptable.

At the time of execution of the Contract, the successful Bidder shall furnish the performance security in accordance with the conditions of Contract in the specimen of performance security provided in the bidding documents.

Failure to comply with the condition as expressed in the specimen of performance security will lead to withdrawal of award and cancellation of Contract, and in this respect EGAT reserves the right to award the Contract to the Bidder with the next lowest evaluated substantially responsive bid and the Bidder who defaults shall have his bid security forfeited in favor of EGAT.

After EGAT notifies the successful Bidder that his bid has been accepted, EGAT will send the Bidder the Contract Documents incorporating all agreements between the parties not later than ninety (90) Days after confirmation of Letter of Award of Contract.

Promptly but not later than fifteen (15) Days after receipt of the Contract, the successful Bidder shall sign and date the Contract and return it to EGAT.

**B-16. Bidder's Responsibility**

The Bidder shall be deemed to have carefully examined all of the terms, conditions and Specifications of this Invitation to Bid, and also to have fully informed himself as to all conditions, local or otherwise, affecting the carrying out of the Work of the Contract, and to have formulated an estimate of the facilities available and needed.

The Bidder shall also be liable to any rules and regulations as well as Acts enforced in the Kingdom of Thailand. Failure to do so will be at the Bidder's risk.

**B-17. Supplemental Notices**

Supplemental Notices to the Bidding Documents may be issued prior to the date of opening of bids to clarify the Bidding Documents or to reflect modifications in the design or Contract terms. Each supplemental notice issued will be distributed to each person or organization to whom the Bidding Documents have been issued. The recipient shall acknowledge receipt of each supplemental notice by signing and returning in a reasonable time the receipt form distributed with the supplemental notice. All supplemental notices issued shall become a part of the Contract Documents.

**B-18. Cost of Bidding**

Bidders will not be reimbursed for any expenses they may incur in preparing and submitting their bids.

**B-19. Cancellation of Bid**

EGAT reserves the right not to accept any quantity or item or schedule or package, or to cancel the bid without purchasing any item. Bidders shall not be entitled to claim EGAT for any losses and/or damages in this connection. EGAT also reserves the right to cancel the bid should there be any reasonable grounds that bidder is not in good faith in submitting bid such as submitting false documents.

In case of bid cancellation, EGAT will not be responsible for any losses and/or damages and will not refund payment of Bidding Documents.

DRAFT

***SPECIMEN OF BID SECURITY***

Whereas.....(hereinafter called "the Bidder") has submitted his bid dated.....for.....(hereinafter called "the Bid") under Invitation to Bid No.....KNOW ALL MEN by these presents that WE.....of.....having our registered office at.....(hereinafter called "the Guarantor") are bound unto Electricity Generating Authority of Thailand (hereinafter called "EGAT") in the sum of..... (in words : ..... ) for which payment well and truly to be made to EGAT, the Guarantor binds itself, its successors and assigns by these presents. Sealed with the Common Seal of the said Bank this.....(date).....day of.....(month)....., .....(year).....

THE CONDITIONS of this obligation are :

1. If the Bidder withdraws his bid during the period of bid validity specified in the Bidding Documents; or
2. If the Bidder, having been notified of the acceptance of his bid by EGAT during the period of bid validity;
  - (a) fails or refuses to execute the Contract, if required; or
  - (b) fails or refuses to furnish the Performance Security, in accordance with the Instructions to Bidders;

We, the Guarantor, unconditionally undertake to pay to EGAT as the primary obligor, up to the above amount upon receipt of its first written demand, without EGAT having to substantiate its demand.

This guarantee will remain in force up to and including ninety (90) Days after the expiry date of the bid validity.

\_\_\_\_\_  
(Signature of the Bank)

**DRAFT**

**SECTION C  
PROPOSAL**

**INVITATION TO BID NO. LPLC-TX-01**

**PROPOSAL**

**FOR**

**SUPPLY OF 333.33 MVA 500 kV POWER TRANSFORMER**

**LONG-TERM INVESTMENT PLAN  
TO ACCOMMODATE LARGE POWER CONSUMER**

---

**C-1. Price Schedule**

The undersigned Bidder, having carefully examined the Bidding Documents, hereby offers and proposes to perform the services and to furnish the Equipment on the basis of FOB Port of Shipment/Vessel or CFR Thai Port as specified in the Delivery Schedule and Distribution List for foreign supply or Ex-works delivery for local supply, in accordance with all provisions and conditions as described herein, all for the prices stated in the Schedule(s) attached.

Note : 1. Article C-1. Price Schedule

For imported Equipment, EGAT reserves the right to award the Contract on either FOB Port of Shipment/Vessel or CFR Thai Port basis.

2. Article E-12. Performance Security

The performance security required under Article E-12. Performance Security shall be ten (10) per cent, round up to the nearest whole number, of the Contract Price. Cost for furnishing the performance security shall be spread over the items proposed.

**C-2. Penalty for Equipment Not Meeting Guaranteed Characteristics**

The losses of Equipment shall be evaluated with the same rate as stipulated in the Proposal Data.

If the Equipment proposed fails to meet the guaranteed characteristics or the price of the measured losses is higher than the price of the guaranteed losses, the Contract price of Equipment shall be reduced by the different amount of the comparison between the price of the measured losses and the price of the guaranteed losses.

**C-3. Guaranteed Delivery Time**

Delivery Time of Equipment is required as indicated in the Delivery Schedule and Distribution List attached. The undersigned Bidder guarantees to make and to complete the delivery of Equipment proposed as required by EGAT.

Whenever the Equipment in any item are sub-itemized, the Contractor shall endeavor not to make partial shipment/delivery by sub-items.

In case of failure on the part of the Contractor to comply with the provision of the above paragraph, it is hereby understood that the Equipment in such particular items shall be deemed undelivered unless and until each all sub-items have been shipped/delivered.

**C-4. Drawing and Document Submission Schedule**

Drawing and Document Submission Schedule is required as indicated in Article F-11. Drawings and Documents to be Furnished by Contractor. The undersigned Bidder guarantees to submit all drawings and documents as required by EGAT.

**C-5. Estimate of Deliveries**

The estimated number of individual shipment/delivery, shipping point or points, estimated delivery date and estimated shipping weights and volumes for each individual shipping will be as follows :

<u>Number of Shipments</u>	<u>Item No.</u>	<u>Shipping Point</u>	<u>Estimated Delivery Date from Shipping Point</u>	<u>Total Weight kg.</u>	<u>Total Volume Cu.m.</u>
-----	-----	-----	-----	-----	-----
-----	-----	-----	-----	-----	-----
-----	-----	-----	-----	-----	-----
-----	-----	-----	-----	-----	-----

**C-6. Bid Security**

Bid security in the amount of \_\_\_\_\_,  
(in words)  
\_\_\_\_\_ has been deposited with EGAT.  
(number)

**C-7. Supplemental Notices**

The undersigned Bidder certifies that the following Supplemental Notices have been received for the Contract Documents :

\_\_\_\_\_  
\_\_\_\_\_  
\_\_\_\_\_  
\_\_\_\_\_  
\_\_\_\_\_

Proposal Submission Date \_\_\_\_\_ Day of \_\_\_\_\_ A.D. \_\_\_\_\_

Firm's Name \_\_\_\_\_

By \_\_\_\_\_

Title \_\_\_\_\_

Firm's Address \_\_\_\_\_

Witness  
\_\_\_\_\_

DRAFT

**PART 1: PRICE PROPOSAL**

## **PART 1 : PRICE PROPOSAL**

### **PRICE QUOTATION INSTRUCTIONS**

This part of the Bidding Document comprises :

1. Summary of Bid Prices
2. Price Schedules

Cost of Supply of Equipment comprises Foreign Portion and Local Portion. For Foreign Portion, Bidder is allowed to quote price in only four (4) different currencies. For Local Portion, default currency is Baht (THB).

Bidder shall fill in the price schedules in the Excel file(s), item by item. Then, the total prices for each schedule and Summary of Bid Prices will be automatically calculated.

Filling-in the data shall be in accordance with the following instructions :

1. Bidder shall fill in all data required in blue cells of the price schedules - Currency and Unit Price.
2. For local portion, the default is THB.
3. For foreign portion, Bidder shall fill a currency code in a column "Currency".

Remarks: Price Schedules are created in Microsoft Office Excel 2007.

**INVITATION TO BID NO. LPLC-TX-01**

**SUMMARY OF BID PRICE**

**SUPPLY OF 333.33 MVA 500 KV POWER TRANSFORMER**

**LONG-TERM INVESTMENT PLAN TO ACCOMMODATE LARGE POWER CONSUMER**

No.	Description	Currency	Supply of Equipment	Supply of Equipment	Foreign Currency (excluding VAT)	Local Currency (excluding VAT) Baht
			Foreign Supply	Local Supply		
			CFR Thai Port	Ex-works Price (excluding VAT) Baht		
			Amount	Amount	Amount	Amount
1	Schedule 1 : 333.33 MVA, 500 kV Auto-Transformer					
<b>BID PRICE</b>				<b>Baht</b>		<b>Baht</b>
<b>VAT</b>				<b>Baht</b>		<b>Baht</b>
<b>SUMMARY OF BID PRICE</b>				<b>Baht</b>		<b>Baht</b>

**INVITATION TO BID NO. LPLC-TX-01**  
**Schedule 1 : 333.33 MVA, 500 kV Auto-Transformer**  
**SUPPLY OF 333.33 MVA 500 KV POWER TRANSFORMER**  
**LONG-TERM INVESTMENT PLAN TO ACCOMMODATE LARGE POWER CONSUMER**

Item No.	Description	Qty.	Unit	Currency	Supply of Equipment				Supply of Equipment		Foreign Currency (excluding VAT)	Local Currency (excluding VAT) Baht
					Foreign Supply				Local Supply			
					FOB Vessel Unit Price	Cost of Transportation to Thai Port Unit Price	CFR Thai Port Unit Price      Amount		Ex-works Price (excluding VAT) Baht Unit Price      Amount			
1-1	333.33 MVA 525/√3,242/√3-22 kV single phase unit autotransformer complete with tank mounted surge arresters, insulating oil and accessories as per Ratings and Features RF TX991A	3									XXXXX	XXXXX
1-2	333.33 MVA 525/√3,242/√3-22 kV single phase unit autotransformer complete with tank mounted surge arresters, insulating oil and accessories as per Ratings and Features RF TX991A, Supply as spare parts	1									XXXXX	XXXXX
1-3	Common Control Cabinet as per Specification No. 711 for Item No. 1-1	1									XXXXX	XXXXX
1-4	Complete Set of one or two units of each type and each size of auxiliary relay (two units are required where five units or more of each type and each size are provided per one transformer bank), Supply as spare parts	1									XXXXX	XXXXX
1-5	Cost of installation supervisor for Item No. 1-1		Man-day		XXXXX	XXXXX	XXXXX	XXXXX	XXXXX	XXXXX		
1-6	Cost of installation supervisor for Item No. 1-2		Man-day		XXXXX	XXXXX	XXXXX	XXXXX	XXXXX	XXXXX		
	Equipment which shall be used together as a complete set referring to Article relevant to Liquidated Damages for Late Delivery of Equipment are Item No. 1-3 with 1-1.											
<b>Total Price for Schedule 1</b>									<b>Baht</b>			<b>Baht</b>

**INVITATION TO BID NO. LPLC-TX-01**  
**Breakdown Unit Price for Item No. 1-1 and 1-2**  
**SUPPLY OF 333.33 MVA 500 KV POWER TRANSFORMER**  
**LONG-TERM INVESTMENT PLAN TO ACCOMMODATE LARGE POWER CONSUMER**

Item No.	Description	Currency	Supply of Equipment				Supply of Equipment	
			Foreign Supply				Local Supply	
			FOB Vessel	Cost of Transportation to Thai Port	CFR Thai Port		Ex-works Price ( excluding VAT ) Baht	
			Unit Price	Unit Price	Unit Price	Amount	Unit Price	Amount
1	Unit price of 333.3 MVA 525/√3,242/√3-22 kV single phase unit autotransformer complete with tank mounted surge arresters and accessories as per Ratings and Features RF TX991A							
2	Price of Insulating Oil for using in one (1) unit of transformer under Item No. 1							

**INVITATION TO BID NO. LPLC-TX-01**  
**Service of Installation Supervisor (Schedule 1)**  
**SUPPLY OF 333.33 MVA 500 KV POWER TRANSFORMER**  
**LONG-TERM INVESTMENT PLAN TO ACCOMMODATE LARGE POWER CONSUMER**

Item No.	Description	Qty.	Unit	Currency	Foreign Currency (excluding VAT)		Local Currency (excluding VAT) Baht	
					Unit Price	Amount	Unit Price	Amount
					1-5	Cost of installation supervisor for Item No. 1-1		Man-day
1-6	Cost of installation supervisor for Item No. 1-2		Man-day					

Note:

1. The quoted total man-days for installation supervisor shall be the required number of days for complete installation, erection, field test and commissioning of all equipment as specified.
2. In addition to the quoted total man-days above, EGAT will also pay the following :
  - a. Travelling time from and to Supervisor's home office as well as travelling time from and to the installation site including ten (10) working days of operation, if any, which will be at the same rate as the cost quoted per man-day.
  - b. Airfares round trip economy class between the Supervisor's home office and Bangkok by the most expeditious and direct route.
3. Local transportation from and to installation site will be provided by EGAT.
4. If the working man-days are less than the quoted total man-days, the payment shall be on the basis of actual man-days.
5. For man-days exceeding the quoted total amount, no payment shall be made by EGAT. Any such additional man-days approved by EGAT shall be paid on the quoted man-days rate.

**INVITATION TO BID NO. LPLC-TX-01**  
**Breakdown Price of Main Part**  
**SUPPLY OF 333.33 MVA 500 KV POWER TRANSFORMER**  
**LONG-TERM INVESTMENT PLAN TO ACCOMMODATE LARGE POWER CONSUMER**

Item No.	Description	Qty.	Unit	Currency	Supply of Equipment				Supply of Equipment	
					Foreign Supply				Local Supply	
					FOB Vessel	Cost of Transportation to Thai Port	CFR Thai Port		Ex-works Price (excluding VAT) Baht	
					Unit Price	Unit Price	Unit Price	Amount	Unit Price	Amount
1	Unit price of HV Bushing under Item No. 1-1 and 1-2	1								
2	Unit price of LV Bushing under Item No. 1-1 and 1-2	1								
3	Unit price of TV Bushing under Item No. 1-1 and 1-2	1								
4	Unit price of Neutral Bushing under Item No. 1-1 and 1-2	1								

**INVITATION TO BID NO. LPLC-TX-01**

**Schedule 1 (Option)**

**SUPPLY OF 333.33 MVA 500 KV POWER TRANSFORMER**

**LONG-TERM INVESTMENT PLAN TO ACCOMMODATE LARGE POWER CONSUMER**

Item No.	Description	Qty.	Unit	Currency	Supply of Equipment				Supply of Equipment	
					Foreign Supply				Local Supply	
					FOB Vessel	Cost of Transportation to Thai Port	CFR Thai Port		Ex-works Price (excluding VAT) Baht	
					Unit Price	Unit Price	Unit Price	Amount	Unit Price	Amount
1	Unit price of non-vacuum (oil immersed interrupter) LTC complete with motor drive mechanism and all LTC accessories for using in transformer under Item No. 1-1 and 1-2	1								
2	Unit price of vacuum interrupter type LTC complete with motor drive mechanism and all LTC accessories for using in transformer under Item No. 1-1 and 1-2	1								
3	Unit price of 192 kV Surge arrester with porcelain housing under Item No. 1-1 and 1-2	1								
4	Unit price of 192 kV Surge arrester with polymer housing under Item No. 1-1 and 1-2	1								
5	Unit price of 24 kV Surge arrester with porcelain housing under Item No. 1-1 and 1-2	1								
6	Unit price of 24 kV Surge arrester with polymeric housing under Item No. 1-1 and 1-2	1								

DRAFT

**PART 2: PROPOSAL DATA**

POWER TRANSFORMER

FORM PD 711  
Jan. 2026

PROPOSAL DATA

PROCUREMENT REFERENCE

SCHEDULE NO.

BIDDER

ITEM NO.

**PART A All Bidders shall meet the following requirements; failure to so comply shall constitute sufficient ground for rejection. (Strictly requirement)**

a. Manufacturer / Country   
In case of proposing the transformer not from an original factory, please specify the name of parent manufacturer/company

b. Type

c. Core Construction Type  Core  Shell

d. Applied Standards

e. Type of Cooling  ONAN/ONAF/ONAF

f. Continuous Max. Rated Power

-HV Side	<input type="text"/>	<input type="text"/>	<input type="text"/>	MVA
-LV Side	<input type="text"/>	<input type="text"/>	<input type="text"/>	MVA
-TV Side	<input type="text"/>	<input type="text"/>	<input type="text"/>	MVA

g. Rated Voltage -HV / LV / TV  kV

h. Rated Current at Max. Rating -HV / LV / TV  A

i. Rated Lightning Impulse Withstand Voltage (BIL) of Windings -HV / LV / TV / Neutral  kV

j. Impedance Voltage bases on Max. Rating of Each Winding at Tap Voltage, Current, Frequency and 80 °C

	Max. Tap Voltage	Rated Tap Voltage	Min. Tap Voltage	
Positive Sequence				
HV-LV ( <input type="text"/> MVA Base)	<input type="text"/>	<input type="text"/>	<input type="text"/>	%
LV-TV ( <input type="text"/> MVA Base)	<input type="text"/>	<input type="text"/>	<input type="text"/>	%
HV-TV ( <input type="text"/> MVA Base)	<input type="text"/>	<input type="text"/>	<input type="text"/>	%
Zero Sequence				
HV-LV ( <input type="text"/> MVA Base)	<input type="text"/>	<input type="text"/>	<input type="text"/>	%
LV-TV ( <input type="text"/> MVA Base)	<input type="text"/>	<input type="text"/>	<input type="text"/>	%
HV-TV ( <input type="text"/> MVA Base)	<input type="text"/>	<input type="text"/>	<input type="text"/>	%

Transformer with De-Energized Tap Changer

Positive Sequence HV-LV (  MVA Base)

Max. Tap of De-Energized Tap Changer	<input type="text"/>	<input type="text"/>	<input type="text"/>	%
Min. Tap of De-Energized Tap Changer	<input type="text"/>	<input type="text"/>	<input type="text"/>	%

Tolerance for HV-LV Positive Sequence  %

Impedance of All Taps Connection  %

Remark

**POWER TRANSFORMER**

FORM PD 711  
Jan. 2026

**PROPOSAL DATA**

**PROCUREMENT REFERENCE**

**SCHEDULE NO.**

**BIDDER**

**ITEM NO.**

- k. Temperature Rise
  - Average Winding / Hot-spot Winding  °C
  - Top Insulating Liquid  °C
- l. Sound Pressure Level
  - No load audible sound level at Rated Voltage and Frequency:  
Without Fan / With All Fans  dB(A)
  - Load audible sound level at Rated Current and Frequency:  
Without Fan / With All Fans  dB(A)
- m. Transformer Tank
  - Transformer Cover: Welded Type  Confirm
  - Transformer Base: Structural Steel Skid Base  Confirm
- n. Regulated Capacity
  - Full Capacity at all Tap  Confirm
- o. Pressure Withstanding
  - Tank  kg/cm<sup>2</sup>
  - Conservator  kg/cm<sup>2</sup>
- p. Shipping Weight  kg
- q. Shipping Dimension
 

Width	Length	Height	
<input type="text"/>	<input type="text"/>	<input type="text"/>	m × m × m

**Remark**

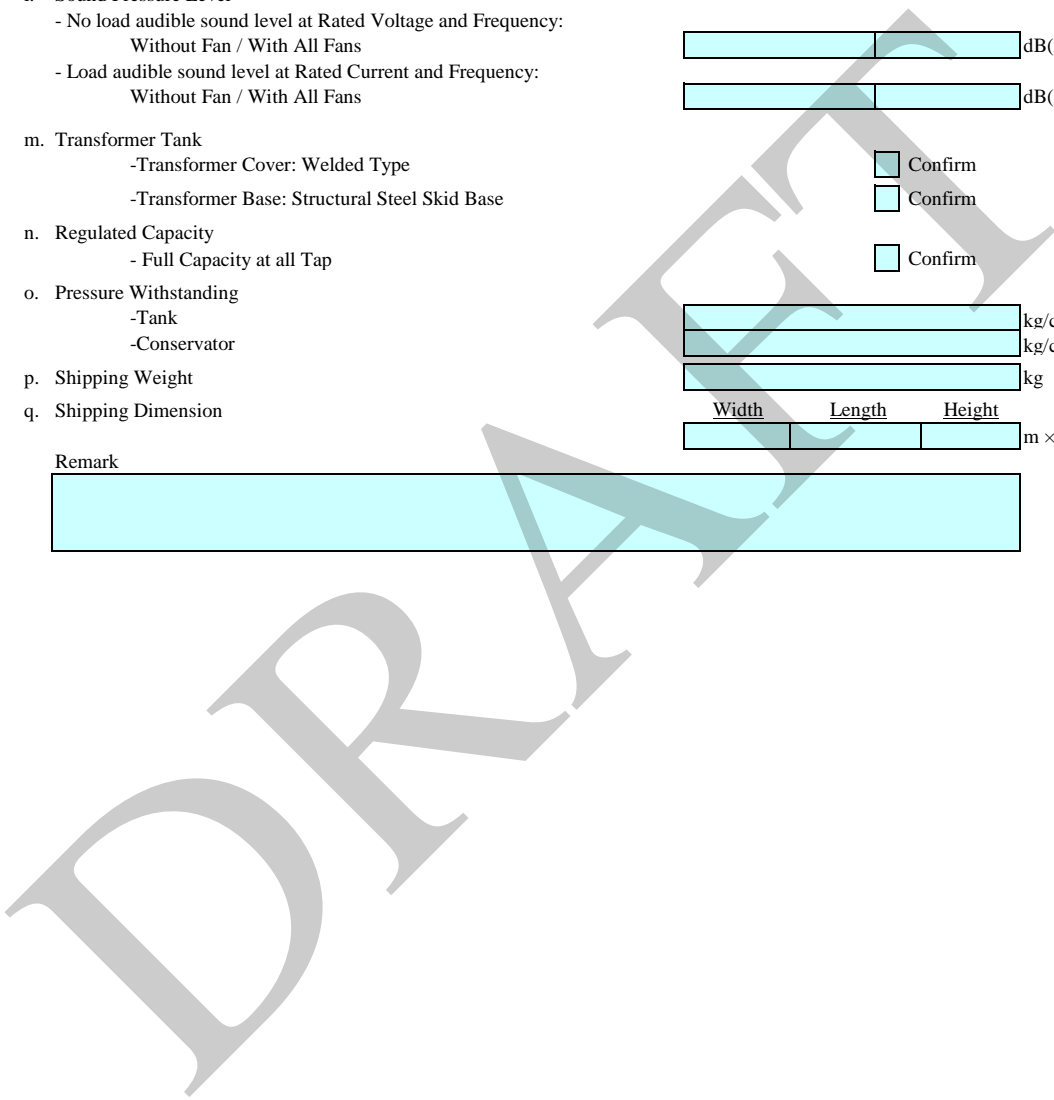

POWER TRANSFORMER

FORM PD 711  
Jan. 2026

PROPOSAL DATA

PROCUREMENT REFERENCE

LPLC-TX-01

SCHEDULE NO.

BIDDER

ITEM NO.

Guarantee Period

\_\_\_\_\_ Years

Guaranteed Characteristics

-No-load Loss at Rated Voltage and Frequency

\_\_\_\_\_ kW

-Load Loss at Rated Current, Frequency and

Max. Capacity at 80 °C

HV-LV

\_\_\_\_\_ kW ( \_\_\_\_\_ MVA Base)

LV-TV

\_\_\_\_\_ kW ( \_\_\_\_\_ MVA Base)

HV-TV

\_\_\_\_\_ kW ( \_\_\_\_\_ MVA Base)

-Auxiliary Power Loss (Fans and/or Pumps)

at Max. Capacity of Transformer

\_\_\_\_\_ kW

-Total Losses at Rated Voltage, Frequency and

Max. Capacity Including Power Requirement

for Fans and/or Oil Pumps

(Excluding HV-TV and LV-TV Load Loss)

\_\_\_\_\_ kW

Important Notice

- 1) The guaranteed characteristics of no-load loss, auxiliary power loss and HV-LV load loss, excluding HV-TV and LV-TV load loss, shall be evaluated and included in the bid price for cost evaluation with the rate of

420,000 Baht for each kW or part thereof of the guaranteed no-load loss.

189,000 Baht for each kW or part thereof of the guaranteed load loss and auxiliary power loss.

If the transformers fail to meet the guaranteed characteristics herein indicated, the price of transformers shall be reduced in accordance with the condition specified in Article : **Penalty for Equipment not Meeting Guaranteed Characteristics.**

Remark

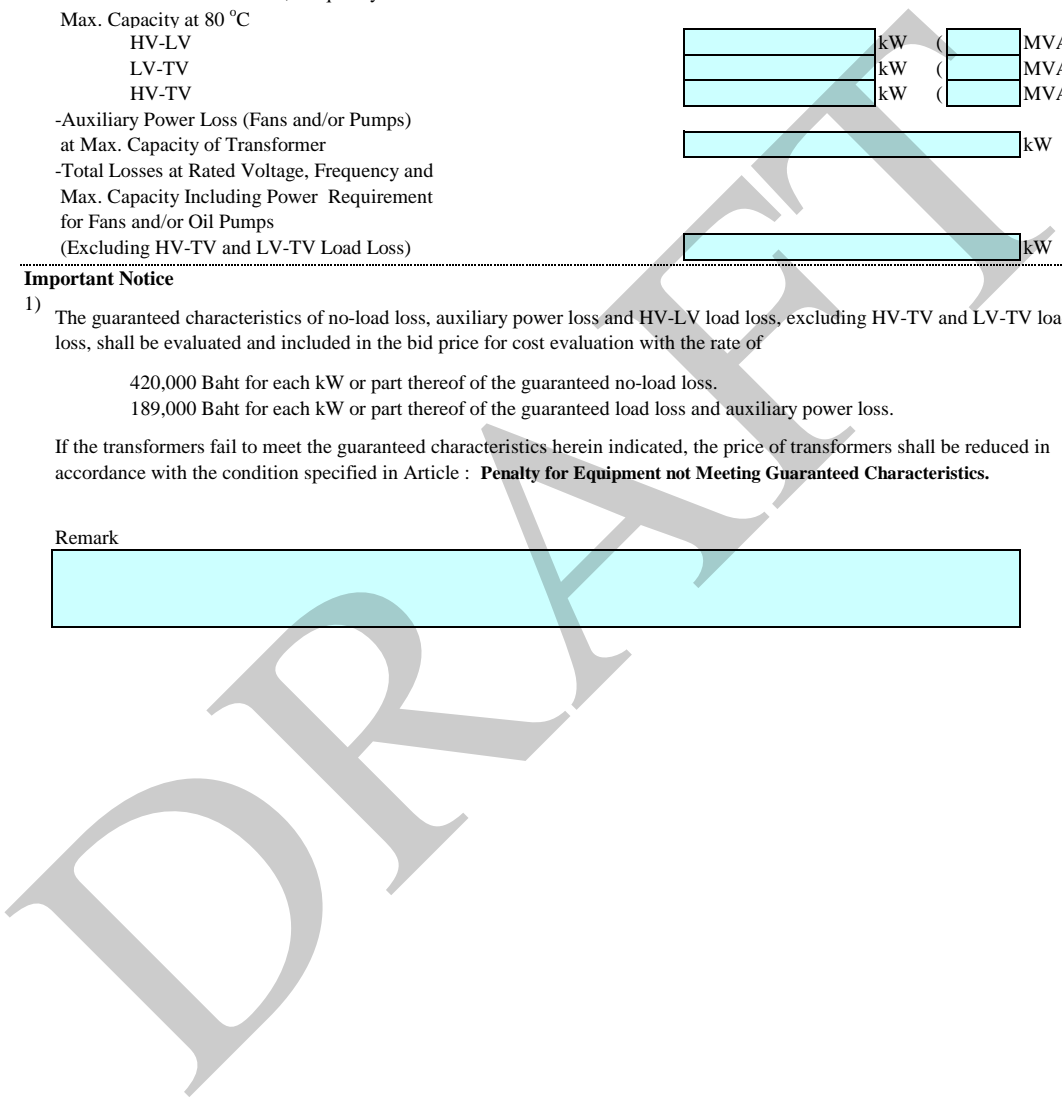



POWER TRANSFORMER

FORM PD 711  
Jan. 2026

PROPOSAL DATA

PROCUREMENT REFERENCE

SCHEDULE NO.

BIDDER

ITEM NO.

d. On Load Tap Changer (LTC)

-Manufacturer / Country

-Type / Model No.

-Max. Rated Through Current

 A

-Max. Allowable Step Voltage

 V

-Rated Impulse Withstand Voltage

 kV

-Short Time Withstand Current / Duration

 kA /  s

-Tapping Range and Volts per Step

-Operating Time for One Complete Tap

 s

-Time Interval Before Operation in another Series of One Cycle

 s

-Tap Positions provided with Idle Tap

 Yes  No

-Location of LTC in Tap Winding

 Line End  Neutral

 Middle

-Compartment of Diverter Switch and Tap Selector

 Separate  Combine

-Diverter Switch

-Contact Life (Switching Operation)

 Times

-Inspection Interval

 Times

-Switching Operation

 Years

-Equivalent to (Whichever is Earlier)

-The Transition Resistor Withstand One Cycle of Uninterrupted Operation

 Yes  No

-Internal Gas Pressure Withstanding for Diverter Switch Tank

 kg/cm<sup>2</sup>

-Operating Time

 ms

-Resistance of Transition Resistor

 W

-Motor Drive Mechanism

-Manufacturer / Country

-Type / Model No.

-Voltage Rating

-Motor Circuit

 V

-Control Circuit (125 VDC is preferred)

 V

-Oil Filter Unit

-Manufacturer / Country

-Type / Model No.

-Voltage Rating

-Motor Circuit

 V

-Control Circuit

 V

Remark

POWER TRANSFORMER

FORM PD 711  
Jan. 2026

PROPOSAL DATA

PROCUREMENT REFERENCE

LPLC-TX-01

SCHEDULE NO.

BIDDER

ITEM NO.

e. High Voltage Bushing

-Manufacturer / Country

-Model No.

-Housing

Porcelain  Composite

-Type

Condenser  Draw Lead

Solid  Fixed Conductor

Other

-Power Freq. Withstand (Dry / Wet)

-Rated Lightning Impulse Withstand Voltage (BIL)

-Rated Current

-Creepage Distance

f. Low Voltage Bushing

-Manufacturer / Country

-Model No.

-Housing

Porcelain  Composite

-Type

Condenser  Draw Lead

Solid  Fixed Conductor

Other

-Power Freq. Withstand (Dry / Wet)

-Rated Lightning Impulse Withstand Voltage (BIL)

-Rated Current

-Creepage Distance

g. Tertiary Bushing

-Manufacturer / Country

-Model No.

-Housing

Porcelain  Composite

-Type

Condenser  Draw Lead

Solid  Fixed Conductor

Other

-Power Freq. Withstand (Dry / Wet)

-Rated Lightning Impulse Withstand Voltage (BIL)

-Rated Current

-Creepage Distance

h. Neutral Bushing

-Manufacturer / Country

-Model No.

-Housing

Porcelain  Composite

-Type

Condenser  Draw Lead

Solid  Fixed Conductor

Other

-Power Freq. Withstand (Dry / Wet)

-Rated Lightning Impulse Withstand Voltage

-Rated Current

-Creepage Distance

Remark

**POWER TRANSFORMER**

FORM PD 711  
Jan. 2026

**PROPOSAL DATA**

**PROCUREMENT REFERENCE**

LPLC-TX-01

**SCHEDULE NO.**

**BIDDER**

**ITEM NO.**

i. Bushing Current Transformer (BCT) As Required  
-Manufacturer / Country

Yes  No

j. BCT for LTC Overcurrent Protection  
-Manufacturer / Country  
-Model No.  
-Current Ratio  
-Accuracy Class / Burden

A  
VA

k. Radiator Manufacturer / Country  
-Pressure Withstanding

kg/cm<sup>2</sup>

l. Rubber Bag Manufacturer / Country  
-Pressure Withstanding

kg/cm<sup>2</sup>

m. Insulating Material

Winding Insulation Paper

-Manufacturer/Country

-Temp. Class

Pressboard and Other Insulating Material

-Manufacturer/Country

-Temp. Class

n. Insulating Oil

-Type

Uninhibited  Inhibited

-Manufacturer / Country

- Additive Content

-Oxide Inhibitor Content

%

-Other Additive Content

%

(Please specify the purpose of other additives)

-Manufacturer Type (Generic Name)

-Applied Standard

o. Weight

-Core

kg

-Coils

kg

-Insulating Material (Pressboard and Paper)

kg

-Tank and Fittings

kg

-Quantity of Oil Furnished

-Transformer

kg Litre

-On Load Tap Changer

kg Litre

-Total Weight With Oil

kg

p. Dimension

-Overall Dimension

Width	Length	Height

m × m × m

q. Uprighting of Main Tank at Site

Not Required

Remark

**POWER TRANSFORMER**

FORM PD 711  
Jan. 2026

**PROPOSAL DATA**

**PROCUREMENT REFERENCE**

**SCHEDULE NO.**

**BIDDER**

**ITEM NO.**

**(For Core Type) This part will be kept as a confidential data by EGAT.**

**Winding Data**

	<u>HV</u> <small>(Series)</small>	<u>LV</u> <small>(Common)</small>	<u>TV</u>	<u>Tap</u>	
Winding Height (Coil Part Only)					mm
Winding Width					mm
Gap Distance					
-Between Top Yoke and Winding					mm
-Between Bottom Yoke and Winding					mm
Inner Radius of Winding					mm
Number of Turns					
Number of Disk or Layer					
Number of Turns Per Disk or Layer					
Number of Conductor or Cable per Turn					
Stranded Copper Conductor or Cable					
- Conductor Strand Dimension					mm × mm
- Number of Strands per Conductor					
- Stiffness (EI Product) of Stranded Conductor in Percent of Equivalent Solid Copper Bar					%
<u>Note</u> E = Modulus of Elasticity I = Moment of Inertia					
Winding Resistance per Phase (at 80 °C)					W/phase
Current Density at Rated Tap Voltage					A/mm <sup>2</sup>
Cross Section Area of Conductor per Turn					mm <sup>2</sup>
Copper Weight per Phase					kg
Radial Spacer Block Between Disk					
-Number of Spacer Blocks					
-Spacer Block Width					mm
-Spacer Block Pitch					mm
Axial Spacer Column Under Winding					
-Number of Spacer Columns					
-Spacer Column Size					mm
Are There Any Axial Spacer Columns (Cooling Ducts) Between Turns or Layer?	<input type="checkbox"/> Yes	<input type="checkbox"/> Yes	<input type="checkbox"/> Yes	<input type="checkbox"/> Yes	
If Yes, Please Show Details.	<input type="checkbox"/> No	<input type="checkbox"/> No	<input type="checkbox"/> No	<input type="checkbox"/> No	
For instance, In a disk winding which has 6 turns per disk inserted with cooling duct between every 2 turns shall be specified as 2 / 2 / 2					

**Important Notice**

2) Detailed calculation showing the electro-mechanical stress / force and short circuit current as proposed in Part C, item a. and b. and information in Winding Data of PART A and B associated with stress-strain curve of proposed copper shall be submitted together with tender document during the bidding as an evidence for consideration of evaluation.

Remark

**POWER TRANSFORMER**

FORM PD 711  
Jan. 2026

**PROPOSAL DATA**

**PROCUREMENT REFERENCE**

LPLC-TX-01

**SCHEDULE NO.**

**BIDDER**

**ITEM NO.**

**Winding Data**

Construction (Air core, Gapped core, etc.)

Winding Height (Coil Part Only)

Winding Width

Gap Distance

-Between Top Yoke and Winding

-Between Bottom Yoke and Winding

Inner Radius of Winding

Number of Turns

Number of Disk or Layer

Number of Turns Per Disk or Layer

Number of Conductor or Cable per Turn

Stranded Copper Conductor or Cable

- Conductor Strand Dimension

- Number of Strands per Conductor

- Stiffness (EI Product) of Stranded

Conductor in Percent of Equivalent

Solid Copper Bar

Note E = Modulus of Elasticity

I = Moment of Inertia

Winding Resistance per Phase (at 80 °C)

Current Density at Rated Tap Voltage

Cross Section Area of Conductor per Turn

Copper Weight per Phase

Radial Spacer Block Between Disk

-Number of Spacer Blocks

-Spacer Block Width

-Spacer Block Pitch (at outermost diameter center to center)

Axial Spacer Column Under Winding

-Number of Spacer Columns

-Spacer Column Size

Are There Any Axial Spacer Columns

(Cooling Ducts) Between Turns or Layer?

If Yes, Please Show Details.

For instance, In a disk winding which has

6 turns per disk inserted with cooling

duct between every 2 turns shall be

specified as 2 / 2 / 2

**Reactor (If Any)**

mm

mm

mm

mm

mm

mm × mm

%

%

%

%

%

%

W/phase

A/mm<sup>2</sup>

mm<sup>2</sup>

kg

mm

mm

mm

Yes  No

Note :

1. Please show winding connection diagram between Reactor and Winding.
2. If there are protective devices, Please provide information of specification and rating.
3. Detailed calculation showing the electro-mechanical stress / force and short circuit current for Reactor winding and information of stress-strain curve of proposed copper shall be submitted together with tender document during the bidding as an evidence for consideration of evaluation.

Remark

**POWER TRANSFORMER**

FORM PD 711  
Jan. 2026

**PROPOSAL DATA**

**PROCUREMENT REFERENCE**

**SCHEDULE NO.**

**BIDDER**

**ITEM NO.**

**(For Shell Type) This part will be kept as a confidential data by EGAT.**

**Winding Data**

- Number of Turns
- Number of Coil Group
- Number of Disk per Coil Group
- Winding Resistance per Phase (at 80 °C)
- Current Density at Rated Tap Voltage
- Cross Section Area of Conductor per Turn
- Copper Weight per Phase

	<u>HV</u> <small>(Series)</small>	<u>LV</u> <small>(Common)</small>	<u>TV</u>	<u>Tap</u>	
					W/phase
					A/mm <sup>2</sup>
					mm <sup>2</sup>
					kg

The above required data are specified for overview of each winding. In addition to "PART B (for Shell Type)", bidder shall submit the sketch or drawing of coil groups in the core window, which is clearly shown the arrangement of each disk (pan cake disk). The coil group dimension and the clearance dimension between pan cake disks shall be included. Each disk shall also be given with the following information:-

- Dimension on The Disk (inner and outer of circumference)
- Number of Turns
- Number of Conductor or Cable per Turn
- Number of Strand per Conductor or Cable
- Copper Weight of Disk
- Cooling Duct on The Disk (Size, Thickness and Clearance between Ducts)

The construction dimension of tank structure subjected to the short circuit force shall be submitted.

**Important Notice**

- 2) Detailed calculation showing the electro-mechanical stress / force and short circuit current as proposed in Part C, item a. and b. and information in Winding Data of PART A and B associated with stress-strain curve of proposed copper shall be submitted together with tender document during the bidding as an evidence for consideration of evaluation.

Remark

**POWER TRANSFORMER**

FORM PD 711  
Jan. 2026

**PROPOSAL DATA**

**PROCUREMENT REFERENCE** LPLC-TX-01

**SCHEDULE NO.**  

**BIDDER**  

**ITEM NO.**  

**PART C Information for reference**

a. Electro-Mechanical Stress/Force  
under Short Circuit Condition

Radial Hoop Compressive Stress

	Occurring (1) Level	Design to be (2) Withstand Level	Critical (3) Level	
-HV(Series) Winding				kg/cm <sup>2</sup>
-LV(Common) Winding				kg/cm <sup>2</sup>
-TV Winding				kg/cm <sup>2</sup>
-Tap Winding				kg/cm <sup>2</sup>

Radial Tensile Stress

-HV(Series) Winding				kg/cm <sup>2</sup>
-LV(Common) Winding				kg/cm <sup>2</sup>
-TV Winding				kg/cm <sup>2</sup>
-Tap Winding				kg/cm <sup>2</sup>

Max. Axial Bending Stress on Conductor

-HV(Series) Winding				kg/cm <sup>2</sup>
-LV(Common) Winding				kg/cm <sup>2</sup>
-TV Winding				kg/cm <sup>2</sup>
-Tap Winding				kg/cm <sup>2</sup>

Tilting Force on Conductor

-HV(Series) Winding				kg
-LV(Common) Winding				kg
-TV Winding				kg
-Tap Winding				kg

Axial Stress on Spacer Surface

-HV(Series) Winding				kg/cm <sup>2</sup>
-LV(Common) Winding				kg/cm <sup>2</sup>
-TV Winding				kg/cm <sup>2</sup>
-Tap Winding				kg/cm <sup>2</sup>

Maximum Axial Compressive Force

-HV(Series) Winding				kg
-LV(Common) Winding				kg
-TV Winding				kg
-Tap Winding				kg

Maximum Winding End Support Force

-Upper Support (for Core Type)				kg
-Lower Support (for Core Type)				kg
-Tank and Core (for Shell Type)				kg

(1) Values from proposed short circuit current calculation.

(2) Design levels proposed by Bidder.

(3) If the stresses/forces exceed these levels, the transformer will be damaged.

Number of Fault Occurrence Rates which the Transformer  
Can Withstand with Expected Transformer Life of 25 Years

-100% Current Intensity		Times/Year
-50% Current Intensity		Times/Year
-20% Current Intensity		Times/Year

Where 100 % Current Intensity Means the Maximum Value of the Short Circuit Current.

Remark

POWER TRANSFORMER

FORM PD 711  
Jan. 2026

PROPOSAL DATA

PROCUREMENT REFERENCE

LPLC-TX-01

SCHEDULE NO.

BIDDER

ITEM NO.

b. Short Circuit condition applied for Electro-Mechanical Stress/Force.

HV      LV      TV      Tap  
(Series)    (Common)

Radial Hoop Compressive Stress

Fault Type (3f, 1f-G, etc.)

Fault Side

Tap Position

System Zero Sequence Impedance in

Term of  $X_0/X_1$  (for 1f-G fault)

-HV Side ( $X_{0H}/X_{1H}$ )

-LV Side ( $X_{0L}/X_{1L}$ )

Short Circuit Current in Winding

-Symmetrical Current

-Asymmetrical Current

Voltage Level in Percent of Rated

Tap Voltage Maintain on Unfault

Terminal During Short Circuit



				kA rms
				kA peak
				%

Radial Tensile Stress

Fault Type (3f, 1f-G, etc.)

Fault Side

Tap Position

System Zero Sequence Impedance in

Term of  $X_0/X_1$  (for 1f-G fault)

-HV Side ( $X_{0H}/X_{1H}$ )

-LV Side ( $X_{0L}/X_{1L}$ )

Short Circuit Current in Winding

-Symmetrical Current

-Asymmetrical Current

Voltage Level in Percent of Rated

Tap Voltage Maintain on Unfault

Terminal During Short Circuit



				kA rms
				kA peak
				%

Axial Bending Stress on Conductor

Fault Type (3f, 1f-G, etc.)

Fault Side

Tap Position

System Zero Sequence Impedance in

Term of  $X_0/X_1$  (for 1f-G fault)

-HV Side ( $X_{0H}/X_{1H}$ )

-LV Side ( $X_{0L}/X_{1L}$ )

Short Circuit Current in Winding

-Symmetrical Current

-Asymmetrical Current

Voltage Level in Percent of Rated

Tap Voltage Maintain on Unfault

Terminal During Short Circuit



				kA rms
				kA peak
				%

Remark

POWER TRANSFORMER

FORM PD 711  
Jan. 2026

PROPOSAL DATA

PROCUREMENT REFERENCE

SCHEDULE NO.

BIDDER

ITEM NO.

	HV (Series)	LV (Common)	TV	Tap	
<b>Tilting Force on Conductor</b>					
Fault Type (3f, 1f-G, etc.)					
Fault Side					
Tap Position					
System Zero Sequence Impedance in Term of $X_0/X_1$ (for 1f-G fault)					
-HV Side ( $X_{0H}/X_{1H}$ )					
-LV Side ( $X_{0L}/X_{1L}$ )					
Short Circuit Current in Winding					
-Symmetrical Current					kA rms
-Asymmetrical Current					kA peak
Voltage Level in Percent of Rated					%
Tap Voltage Maintain on Unfault Terminal During Short Circuit					
<b>Axial Stress on Spacer Surface</b>					
Fault Type (3f, 1f-G, etc.)					
Fault Side					
Tap Position					
System Zero Sequence Impedance in Term of $X_0/X_1$ (for 1f-G fault)					
-HV Side ( $X_{0H}/X_{1H}$ )					
-LV Side ( $X_{0L}/X_{1L}$ )					
Short Circuit Current in Winding					
-Symmetrical Current					kA rms
-Asymmetrical Current					kA peak
Voltage Level in Percent of Rated					%
Tap Voltage Maintain on Unfault Terminal During Short Circuit					
<b>Maximum Axial Compressive Force</b>					
Fault Type (3f, 1f-G, etc.)					
Fault Side					
Tap Position					
System Zero Sequence Impedance in Term of $X_0/X_1$ (for 1f-G fault)					
-HV Side ( $X_{0H}/X_{1H}$ )					
-LV Side ( $X_{0L}/X_{1L}$ )					
Short Circuit Current in Winding					
-Symmetrical Current					kA rms
-Asymmetrical Current					kA peak
Voltage Level in Percent of Rated					%
Tap Voltage Maintain on Unfault Terminal During Short Circuit					

Remark

POWER TRANSFORMER

FORM PD 711  
Jan. 2026

PROPOSAL DATA

PROCUREMENT REFERENCE

SCHEDULE NO.

BIDDER

ITEM NO.

Maximum Winding End Support Force

- Fault Type (3f, 1f-G, etc.)
- Fault Side
- Tap Position
- System Zero Sequence Impedance in Term of  $X_0/X_1$  (for 1f-G fault)
  - HV Side ( $X_{0H}/X_{1H}$ )
  - LV Side ( $X_{0L}/X_{1L}$ )
- Short Circuit Current in Winding
  - Symmetrical Current
  - Asymmetrical Current
- Voltage Level in Percent of Rated
- Tap Voltage Maintain on Unfault Terminal During Short Circuit

HV (Series)	LV (Common)	TV	Tap
<input type="text"/>	<input type="text"/>	<input type="text"/>	<input type="text"/>
<input type="text"/>	<input type="text"/>	<input type="text"/>	<input type="text"/>
<input type="text"/>	<input type="text"/>	<input type="text"/>	<input type="text"/>

<input type="text"/>	<input type="text"/>	<input type="text"/>	<input type="text"/>	kA rms
<input type="text"/>	<input type="text"/>	<input type="text"/>	<input type="text"/>	kA peak
<input type="text"/>	<input type="text"/>	<input type="text"/>	<input type="text"/>	%

c. Excitation Current in % of Full Load Current at 110% / 100% / 90% / 80 % Rated Voltage

<input type="text"/>	<input type="text"/>	<input type="text"/>	<input type="text"/>	<input type="text"/>	%
----------------------	----------------------	----------------------	----------------------	----------------------	---

d. Overexcitation Capability Duration Time at 110% / 120% / 130% / 150 % of Rated Voltage

<input type="text"/>	<input type="text"/>	<input type="text"/>	<input type="text"/>	<input type="text"/>	s
----------------------	----------------------	----------------------	----------------------	----------------------	---

Information of Guaranteed Loss for Reference (from PART A)

-DC Resistance Loss and Stray Loss at Rated Voltage, Frequency and Max. Capacity at 80 °C

- HV-LV ( MVA Base)
- LV-TV ( MVA Base)
- HV-TV ( MVA Base)

	DC Resistance Loss	Stray Loss
<input type="text"/>	<input type="text"/> kW	<input type="text"/> kW
<input type="text"/>	<input type="text"/> kW	<input type="text"/> kW
<input type="text"/>	<input type="text"/> kW	<input type="text"/> kW

-Stray Loss Component at Rated Voltage, Frequency and Max. Capacity at 80 °C

-Eddy Loss in Conductor of Each Winding

- HV-LV ( MVA Base)
- LV-TV ( MVA Base)
- HV-TV ( MVA Base)

HV (Series)	LV (Common)	TV	Tap	
<input type="text"/>	<input type="text"/>	<input type="text"/>	<input type="text"/>	kW
<input type="text"/>	<input type="text"/>	<input type="text"/>	<input type="text"/>	kW
<input type="text"/>	<input type="text"/>	<input type="text"/>	<input type="text"/>	kW

-Eddy Loss in Core and Clamping Frame

- HV-LV ( MVA Base)
- LV-TV ( MVA Base)
- HV-TV ( MVA Base)

<input type="text"/>	kW
<input type="text"/>	kW
<input type="text"/>	kW

-Eddy Loss in Tank Shield and Other Metallic Parts

- HV-LV ( MVA Base)
- LV-TV ( MVA Base)
- HV-TV ( MVA Base)

<input type="text"/>	kW
<input type="text"/>	kW
<input type="text"/>	kW

Remark









**PART 3: DELIVERY SCHEDULE AND DISTRIBUTION LIST**

**INVITATION TO BID NO. LPLC-TX-01**  
**Delivery Schedule and Distribution List**  
**Long-Term Investment Plan to Accommodate Large Power Consumer**  
**Schedule 1 : 333.33 MVA, 500 kV Auto-Transformer**

Item No.	Description	Qty	Job no.	Substation	Delivery Required by EGAT (within months after confirmation of Letter of Award of Contract)
					CFR Thai Port / Ex-works / DDP EGAT's Store
1-1	333.33 MVA 525/√3,242/√3-22 kV single phase unit autotransformer complete with tank mounted surge arresters, insulating oil and accessories as per Ratings and Features RF TX991A	3	LPLC-01-S08	PDG	20
1-2	333.33 MVA 525/√3,242/√3-22 kV single phase unit autotransformer complete with tank mounted surge arresters, insulating oil and accessories as per Ratings and Features RF TX991A, Supply as spare parts	1	LPLC-01-S08	PDG	20
1-3	Common Control Cabinet as per Specification No. 711 for Item No. 1-1	1	LPLC-01-S08	PDG	20
1-4	Complete Set of one or two units of each type and each size of auxiliary relay (two units are required where five units or more of each type and each size are provided per one transformer bank), Supply as spare parts	1	LPLC-01-S08	PDG	20

Thai Port = Laem Chabang Port, Chonburi

**DRAFT**

**SECTION D  
CONTRACT**

**CONTRACT**  
**SUPPLY OF 333.33 MVA 500 kV POWER TRANSFORMER**  
**LONG-TERM INVESTMENT PLAN**  
**TO ACCOMMODATE LARGE POWER CONSUMER**

---

No. \_\_\_\_\_

This Contract is executed and delivered this \_\_\_\_\_ day of \_\_\_\_\_,  
B.E. \_\_\_\_\_ (A.D. \_\_\_\_\_), between

ELECTRICITY GENERATING AUTHORITY OF THAILAND

represented by \_\_\_\_\_ of said Authority, hereinafter called "EGAT", and

\_\_\_\_\_  
**(Contractor)**

represented by \_\_\_\_\_, age \_\_\_\_\_ years, nationality \_\_\_\_\_, hereinafter called  
the "Contractor".

EGAT and the Contractor mutually agree as follows :

**D-1. Contract Documents**

The following documents attached to this Contract are incorporated and made a part of this  
Contract, as though fully written out and set forth herein :

Data Sheet

- A. Invitation to Bid
- B. Instructions to Bidders
- C. Contract Price, Delivery Time of Equipment and Proposal Data
- D. Contract
- E. General Conditions
- F. Special Conditions
- G. Ratings and Features
- H. Bill of Materials (None)
- I. Specifications
- J. Drawings
- K. Supplemental Notices

\_\_\_\_\_  
\_\_\_\_\_  
\_\_\_\_\_

L. Attachments :

---

---

---

M. Changes :

---

---

---

All of the foregoing documents are referred to herein as the Contract Documents. They are also incorporated into this Contract and made a part hereof all codes, designations, standards, standard specifications and similar Equipment which are referred to in the Specifications and Special Conditions.

**D-2. Acceptance of Proposal**

EGAT has accepted the proposal of the Contractor for furnishing the Equipment in conformity and in accordance with and subject to all the terms and conditions of these Contract Documents.

**D-3. Agreement**

The Contractor agrees to sell and EGAT agrees to buy the Equipment as described in these Contract Documents.

**D-4. Obligation of Contractor**

The Contractor agrees to perform well and faithfully all of the services and to furnish all of the Equipment described in these Contract Documents, and to supply and provide all Equipment, labor and other things requisite for or incidental to the said Work.

**D-5. Obligation of EGAT**

EGAT agrees, subject to the terms and conditions of these Contract Documents, to pay to the Contractor the amount shown, and at the rates and times and in the manner set forth in these Contract Documents.

**D-6. Mutual Obligations**

EGAT and the Contractor mutually agree to perform, fulfill, abide by, and submit to any and all of the provisions and requirements and all matters and things contained or expressed in, or reasonably to be inferred from these Contract Documents.

**D-7. Deposit of Performance Security**

The Contractor agrees to deposit with EGAT an acceptable performance security in accordance with the Contract Documents.

**D-8. Assignment**

The Contract or any part thereof shall not be assigned or pledged without the written consent of EGAT, nor shall the Contractor assign or pledge any money due, or to become due, to him hereunder, without the prior written consent of EGAT.

**D-9. Notices**

All notices called for by the terms of this Contract shall be effective only at the time of receipt thereof and only when received by the parties to whom they are addressed at the following addresses :

EGAT : Governor  
Electricity Generating Authority of Thailand  
Bangkruai, Nonthaburi 11130  
Thailand

Contractor : \_\_\_\_\_  
\_\_\_\_\_  
\_\_\_\_\_  
\_\_\_\_\_

All notices called for by the terms of this Contract shall be in the form of registered letters or *letters submitted electronically or electronic mails (E-mails)* in the English language.

**D-10. Integration**

EGAT and the Contractor agree that this Contract, including the Contract Documents, expresses all of the agreements, understandings, promises, and covenants of the parties, and that it integrates, combines, and supersedes all prior and contemporaneous negotiations, understandings, and agreements, whether written or oral, and that no modification or alteration of this Contract shall be valid or binding on either party, unless expressed in writing and executed with the same formality as this Contract, except as may otherwise be specifically provided in this Contract.

**D-11. Counterpart**

This Contract is executed in two (2) identical counterparts: one (1) for EGAT and one (1) for the Contractor.

ELECTRICITY GENERATING AUTHORITY  
OF THAILAND

CONTRACTOR :

BY \_\_\_\_\_  
( )

BY \_\_\_\_\_  
( )

WITNESS :

WITNESS :

BY \_\_\_\_\_  
( )

BY \_\_\_\_\_  
( )

DRAFT

**SECTION E**  
**GENERAL CONDITIONS**

## GENERAL CONDITIONS

### **E-1. Definitions**

Whenever the following terms are used in the Contract Documents, they will have the following meanings :

- EGAT : The Electricity Generating Authority of Thailand, having its Head Office at Nonthaburi, Thailand, and its authorized representative or representatives
- Engineer : Firm or company assigned by EGAT to provide engineering, consulting or construction management services in support of EGAT
- Bidder : Any person or firm or company or joint venture or consortium of firms submitting bid to EGAT for furnishing the services and Equipment described in the Contract Documents, in response to this Invitation to Bid
- Contractor : Any person or firm or company or joint venture or consortium of firms including appointed representatives, successors and assignees thereof, whose bid has been accepted by EGAT for furnishing of the services and Equipment described in the Contract Documents
- Subcontractor : Any person or firm or company (other than the Contractor) to whom any part of the Contract has been sublet, with the consent of EGAT, by the Contractor
- Contract : The agreement between EGAT and the Contractor, and all Appendices and Schedules thereto including Invitation to Bid, Instructions to Bidders, Proposal, General Conditions, Special Conditions, Specifications, Ratings and Features, Drawings, Supplemental Notices and any other documents referred to in, or connected with the Contract, eventhough the said documents are issued after execution of the Contract
- Contract Price : The sum specified in Section C which is inclusive of VAT (if any) subject to such additions thereto or deductions therefrom as may be made under the provisions hereinafter contained

Equipment	:	Machinery, apparatus, materials, goods, including accessories and spare parts to be supplied under the Contract and specifically described in the Specifications
Work	:	All the work to be done by the Contractor for design manufacture, shop test, transportation, and delivery of the Equipment ex-works, FOB Port of Shipment/Vessel or CFR Thai Port or at EGAT's store/site as agreed, including, if required, supervision for installation at site and supervision for field tests of the Equipment under the Contract
Thai Port	:	Commercial ports in Thailand including but not limited to Bangkok Port, Laem Chabang Port, Sriracha Harbour Port, Siam Seaport, Maptaphut Port, Songkhla Port, Phuket Harbour Port or Suvarnabhumi Airport, as the case may be
Bangkok Port	:	Bangkok Wharf (Klong Toey Port) and all other commercial ports in Bangkok Metropolitan area
Supervisor (if required)	:	Contractor's employee assigned as installation supervisor including assistant supervisor, to supervise and be responsible for the installation, erection, adjustment, field tests, and commissioning of the Equipment supplied under the Contract
Option (if any)	:	Equipment to be quoted by the Bidder which EGAT reserves the right to accept or omit in whole or in part
Year	:	Calendar year
Month	:	Calendar month
Day	:	Calendar day

**E-2. Intent of Contract Documents**

All of the Contract Documents are complementary, and what is called for by one shall be as binding as if called for by all. In the case of any discrepancy between any of the Contract Documents, or any defective description or ambiguity, the matter shall be promptly submitted to EGAT, which shall promptly make a determination in writing. Any adjustment by the Contractor without this determination shall be at the Contractor's own risk and expense. In all cases of discrepancy, defective description, or ambiguities, the interpretation given by EGAT shall be binding on the Contractor, subject to the provisions of Article E-31. Dispute Resolution, included in these General Conditions.

**E-3. Applicable Law and Legal Jurisdiction**

The applicable law of this Contract shall be the law in force in the Kingdom of Thailand. Should there be any ambiguity or discrepancy arising out of or in connection with the Contract Documents, the interpretation thereof shall be made in accordance with Thai laws. Any litigations between the parties that may arise out of or in connection with this Contract or the breach or termination thereof or the performance of work thereunder shall be submitted to the Court of Thailand for decision, except as may be otherwise specifically provided in these Contract documents.

**E-4. Statutory Requirements**

Throughout the continuance of the Contract, the Contractor shall conform to all laws of the Kingdom of Thailand, and to all regulations, by-laws, ordinances, or orders made thereunder, and to the lawful requirements of any public, municipal, or other authority, in any way affecting or applicable to the Contractor or its operations.

**E-5. Patents and Copyrights**

The Contractor shall indemnify and hold EGAT, its officers, agents, and employees harmless against and from liability of any nature or kind, including costs and expenses for or on account of any copyrighted or uncopyrighted composition, secret process, patented or unpatented invention, article, or appliance manufactured, delivered, or used in carrying out the Work under the Contract. All drawings and the information contained therein as well as the use of any process, material or Equipment developed in the course of carrying out the Work under the Contract shall become the property of EGAT where EGAT shall have the right to use any or all of them for any purpose either for present or future projects. For the avoidance of doubt, none of them will be used solely for any commercial benefit which is not related to EGAT work.

#### **E-6. Subcontracts**

The Contractor shall not assign or transfer the Contract or any part thereof or any benefit or interest therein or thereunder, any monies due or become due under this Contract to any other person or persons.

The Contractor shall not be allowed to subcontract the whole of the Work under this Contract. Subcontracting of any part of the Work shall be subject to the prior written consent of EGAT. Such consent, if given, shall not relieve the Contractor from full and entire responsibility under this Contract.

If the Contractor desires to subcontract any part or parts of the Work called for by the Contract, he shall notify EGAT in writing to that effect and shall state in such notice the nature and extent of the part or parts of the Work called for by the Contract proposed to be subcontracted and name of the person proposed as Subcontractor. Unless and until written approval is given by EGAT, approval for which shall not be unreasonably withheld, the Contractor shall not subcontract any part of the Work. All requirements specified in these Contract Documents shall be applicable to Subcontractors also.

No contractual relation shall exist between EGAT and the Subcontractors, and the Subcontractors are not to enjoy any privileges conferred on the Contractor by this Contract.

Any Work done by any Subcontractor who has not been approved by EGAT shall be subject to rejection or stoppage of Work by EGAT. In such case the Contractor cannot claim delay or request for time extension of the Contract completion date and/or make financial claim to EGAT.

#### **E-7. Export Charges**

All tariffs, duties and other taxes or charges levied by the country of origin of the Equipment shall be paid by the Contractor, and such expenses shall be included in the cost of the Equipment.

#### **E-8. Import Duty and Taxes**

EGAT will pay all costs of procuring the necessary permits and licenses for importation into Thailand, and will pay import duty and any taxes including value added tax imposed at the port of entry on the Equipment to be supplied by the Contractor and imported into Thailand for the Work under this Contract.

EGAT will not pay import duty and taxes on either the personal effects of the Contractor's employees, such as personal articles, household furnishings and appliances, and goods of any kind imported for the personal use of the Contractor's employees whether imported by an employee or by the Contractor, or in respect of food, tobacco, liquor and other commissary goods imported by the Contractor or by his employees.

EGAT will not pay import duty and taxes including value added tax on equipment, tools, instruments and machinery imported by the Contractor for purpose of carrying out the work under the Contract. All processes of importation shall be arranged by the Contractor.

Equipment, tools, instruments and machinery which are certified by the Contractor that they are required for installation, test and commissioning of the Work at the site and they are intended for re-exportation can be temporarily exempted from import duty and taxes including value added tax. All Equipment thereof shall be imported under the name of the Contractor and be in accordance with the rules and regulations of the Customs Department of the Kingdom of Thailand.

EGAT will assist the Contractor for such temporary exemption of import duty and taxes including value added tax by issuing a letter confirming such temporary import. Import duty and taxes including value added tax for the temporarily imported Equipment shall be paid by the Contractor to the Customs Department before re-exportation at the rate to be specified by the Customs Department at the time of importation for the whole period they have been imported into the Kingdom of Thailand. Temporary importation of the Equipment is subject to approval of the Customs Department and the deposit of a bond with the Customs Department in the amount to be notified by the Customs Department is required. All costs for submission of information and data if required by the Customs Department and the cost of provision of the bond shall be borne by the Contractor.

In view of numerous advantages, the ATA Carnet system or other systems may be arranged for shipment of the said temporarily imported equipment by the Contractor (if required). Any charge incurred and/or any liability shall be borne by the Contractor.

#### **E-9. Value Added Tax**

Pursuant to the Revenue Code of Thailand, EGAT shall be responsible and pay when due for the value added tax imposed on the supply of Equipment, including local transportation (if any) and/or on the provision of services under this Contract. EGAT shall in no case be responsible for the value added tax collectible on any payment made by the Contractor under any subcontract or under any other circumstances and the Contractor shall comply with the rules and regulations of the Revenue Code of Thailand.

In case there is any change on the rate of value added tax imposed by the Government of Thailand, the amount of value added tax comprised in the Contract Price shall be adjusted to reflect such change, provided that the price of the Work shall remain unchanged.

**E-10. Income and Other Taxes**

Income and other taxes assessed or collected by the Government of Thailand, or any subdivision thereof, or any municipality therein on the Contractor and his employees shall be under the responsibility and account of the Contractor.

In accordance with the Revenue Code of Thailand, should the payment under this Contract be subject to income tax and withholding tax of any kind is required to be withheld by EGAT, such withholding tax shall be deducted by EGAT from each payment and EGAT will be responsible to remit such withholding tax to the Revenue Department of Thailand on behalf of the Contractor. In case any payment being made through the letter of credit or being made directly from foreign source whereby the withholding tax cannot be deducted from payment, the Contractor is required to immediately inform EGAT once each such payment is made to the Contractor, and the withholding tax of which will be paid from EGAT's own fund to the Revenue Department in the same manner as aforesaid. Such withholding tax amount as advanced by EGAT on behalf of the Contractor shall be reimbursed by the Contractor to EGAT within the period of time fixed by EGAT.

In the case where the Contractor considers that the transaction under this Contract is exempted from income tax of Thailand (under any circumstance), the Contractor shall submit, together with his proposal(s), a statement detailing such exemption and the valid documentary evidence. Should EGAT rely on the statement so submitted, no deduction for withholding tax shall be made from payment. However, if the tax authority of Thailand determines that such exemption is not applicable, the Contractor shall then be responsible for the amount(s) equal to the withholding tax, plus the amount(s) of tax exceeding those of withholding tax, including the surcharge and/or penalties imposed on EGAT and the Contractor. The responsibility and liability of the Contractor as provided in the preceding sentence shall survive termination of the Contract.

If the Contractor fails to immediately inform EGAT of the payment as required under the second paragraph preventing EGAT from remitting the withholding tax to the Revenue Department within seven (7) Days from the end of the month in which such payment is made, or fails to pay and/or reimburse EGAT for any amount required under this Article within the period of time fixed by EGAT, such period not to be shorter than fifteen (15) Days from the date of EGAT's notice for payment, EGAT has the right to claim directly from the Contractor or claim from Performance Security or Maintenance Security, as the case may be, or deduct or setoff from any money due to the Contractor under this Contract

for the outstanding amount, surcharge and/or penalty (if any) together with interest at the rate of Minimum Overdraft Rate (MOR) plus two (2) per cent calculated from the due date up to the date the payment is made in full.

EGAT will proceed with the tax matters under the Contract by relying on the information and document submitted by the Contractor in relation to the Bidder's status and tax liability. If the Revenue Department of Thailand differently determines the status and tax liability, the Contractor shall be responsible and liable for any cost and expense, penalty and/or surcharge incurred and/or imposed on him and EGAT in relation thereto.

#### **E-11. Fees and Duties**

Any and all immigration fees, stamp duties, and other fees assessed or collected by the Government of Thailand, or by any subdivision thereof, or by any municipality therein, on this Contract, on the Contractor and/or his personnel shall be paid by the Contractor. Any taxes collectible under this Contract, other than those stipulated in this Contract, shall be at the responsibility and account of the Contractor.

The stamp duty for any service contract (Construction, Hire of Work, Consultancy Service, Transportation, Supervisor, etc.) with the Contract value of the service portion lower than baht 200,000.- is required to be affixed by the Contractor on the original copy and the counterpart of the Contract. In case the value of the service portion is baht 200,000.- and over, payment of such stamp duty by the Contractor shall be made in cash to the Revenue Department of Thailand or its authorized subdistrict offices. In either case, the stamp duty is required to be affixed or paid, as the case may be, within fifteen (15) Days after the date of Contract execution, otherwise the Contractor shall be liable to pay for any and all penalties imposed for the delay as required by law.

The Contract value of the service portion to be calculated for stamp duty under this provision shall be the price excluding value added tax.

For a foreign Contractor who has no representative in Thailand, EGAT will, upon receipt of written request from the Contractor, affix or pay for stamp duties from EGAT's own fund on behalf of the Contractor, the Contractor is therefore required to reimburse EGAT for such stamp duties plus any and all penalties imposed by law for delay, if such delay is due to Contractor's failure to make written request to EGAT as aforesaid within a reasonable period of time.

If the Contractor fails to reimburse EGAT for any and all amount as required under this Article within the period of time fixed by EGAT, such period not to be shorter than fifteen (15) Days from the date of EGAT's notice for payment, EGAT has the right to claim directly from the Contractor or claim from Performance Security or Maintenance Security,

as the case may be, or deduct or setoff from any and all money due to the Contractor under this Contract for the outstanding amount together with interest at the rate of Minimum Overdraft Rate (MOR) plus two (2) per cent calculated from the due date up to the date the payment is made in full.

#### **E-12. Performance Security**

The Contractor shall, at the time of execution of the Contract, deposit with EGAT a performance security for the due and proper performance of this Contract in the amount of ten (10) per cent, round up to the nearest whole number, of the total Contract Price. The performance security shall insure payment of any obligations, penalty, damages, liquidated damages, or expenses for which the Contractor may become liable to EGAT.

The amount of the performance security shall be adjusted or the Contractor may deposit a new performance security in the amount of ten (10) per cent, round up to the nearest whole number, of the additional Contract Price to cover the Contractor's obligation in case the Contract Price is increased due to change of the Work under the Article E-21. Changes and Extra or Omitted Work.

The performance security shall be in the form of a cash deposit, or a cashier cheque issued by a local bank, or a bank guarantee or letter of guarantee issued only by a local bank or an acceptable financial institution in Thailand, or by a foreign bank counter-guaranteed by a local bank and, made payable to EGAT in the same currency as that of the Contract. In case of a cash deposit or a cashier cheque, only Thai baht portion of the Contract Price can be made. EGAT may at any time, upon application by the Contractor, approve the substitution for any performance security held under this Article by other performance security on such terms and conditions as may be approved by EGAT. The Contractor shall bear the cost of the performance security.

The conditions of the guarantor's obligations in the performance security shall include, inter alia, the following :

- (1) The guarantor shall unconditionally guarantee, as primary obligor and not as surety merely, payment of any obligations, penalties, damages, liquidated damages, or expenses for which the Contractor may become liable to EGAT.
- (2) No extension of time, change in, addition to, or other modification of the terms of the Contract or Work to be performed thereunder, or of the specifications or other Contract Documents shall in anyway release the guarantor from any liability under the performance security, and the guarantor shall thereby waive notice of any such extension of time, change, addition or modification.

- (3) The performance security shall be valid and remain in full effect from the date of execution of the Contract until the issuance of the Acceptance Certificate by EGAT or the acceptance of Equipment deemed to be made by EGAT against submission of the Maintenance Security accepted by EGAT.

Unless and until an official receipt is issued in respect to a security deposit, EGAT will not recognize or accept any such deposit as fulfilling the requirements of this Article. Failure to deposit a performance security at the time specified above in this Article or such extended time as may be approved by EGAT shall be a breach of this Contract and EGAT is entitled to terminate the Contract or suspend any payment for Work performed until the performance security has been accepted by EGAT. EGAT shall not be liable for any losses, expenses and/or damages resulting from such payment suspension.

If any performance security furnished under this Article becomes unacceptable to EGAT, or if any guarantor fails to furnish reports as to guarantor's financial condition from time to time, as requested by EGAT, the Contractor shall promptly furnish such additional or alternative security as may be required by EGAT from time to time to protect the interests of EGAT up to an amount equal to the amount of the security.

In the event of any default or breach of this Contract by the Contractor, EGAT may convert into money any performance security which does not consist of money, and the proceeds shall be deemed to be a cash deposit under this Article. EGAT shall not be liable for any cost, expenses and/or loss incurred in connection with such conversion.

The performance security, in case of a bank guarantee, or letter of guarantee, shall be in conformity with the specimen acceptable to EGAT as shown herein at the end of these General Conditions.

### **E-13. Inspection and Tests**

All Equipment furnished and all Work performed under this Contract shall be subject to inspection by EGAT or EGAT's authorized representatives at its option. While such Work is in progress to ascertain that the completed Work will comply in all respects with the standards and requirements set forth in the Contract Documents. Notwithstanding such inspection, the Contractor will be responsible for the acceptability of the finished Work.

EGAT or EGAT's representatives shall at all times have access to the Work whenever it is in preparation or progress and the Contractor shall provide proper facilities for such access and shall furnish promptly, without additional charge, all facilities, labor and material reasonably needed for safe and convenient inspection by EGAT or EGAT's representatives. The Contractor shall notify EGAT at least two (2) Months in advance

when and where the Equipment and the Work will be available for each inspection and test. Any expense incurred by EGAT or EGAT's representatives to inspect the Equipment and the Work or to attend the test caused by false call of the Contractor for inspection and tests shall be borne by the Contractor.

If any Work should be covered up, or otherwise made inaccessible, without the approval of EGAT, it shall, if required by EGAT, be uncovered and made accessible for examination. Any such cover, which is required in the finished Work, shall be restored to EGAT's satisfaction at the Contractor's expense.

The acceptance of any Work or Equipment covered by these Contract Documents, or the making or waiving of any inspection or witnessing of any tests shall in no way relieve the Contractor of full responsibility for the quality, character and satisfactory operation and performance of the complete Work, and every part of it, as outlined in these Contract Documents, nor shall it prejudice or affect the rights of EGAT as set forth in the Contract.

Unless otherwise specifically provided in the Contract, the expenses directly required for all labor, tools, instruments, other materials and Equipment necessary for performance of the tests shall be borne by the Contractor.

The Contractor shall at his own expense conduct shop tests in accordance with the Specifications and submit the results of the tests to EGAT upon completion of tests. EGAT reserves the right to inspect all Equipment either in person or via video conference during its manufacture or fabrication and prior to its preparation for shipment, to inspect its packing when ready for shipment, and to witness any or all tests.

In the event the results of the tests do not satisfy the requirements of the Specifications or the guaranteed performance, the Contractor shall rectify to improve the Equipment until satisfactory results are obtained and shall conduct all necessary retests at his own expense.

Any delay in delivery due to the retest shall not constitute a release of the Contractor from his responsibility for delay. Any expenses incurred by EGAT in attending these retests shall be borne by the Contractor.

EGAT reserves the right to send one or more of EGAT's employees, not as inspectors, to the Contractor's plant to witness the fabrication, assembly and testing of any or all parts of the Equipment being furnished under this Contract. Travelling expenses and per diem of such employee or employees shall be borne by EGAT.

#### **E-14. Preparation for Shipment and/or Delivery**

The Contractor shall submit shipment and/or delivery schedule for EGAT's approval at least thirty (30) Days in advance before each shipment and/or delivery is made. No shipment and/or delivery shall be made prior to EGAT's approval which will be notified to the Contractor within fifteen (15) Days after receipt of the said shipment and/or delivery schedule.

All imported and local Equipment to be delivered under this Contract shall be satisfactorily packaged in such a manner to protect them from damage during transportation and for outdoor storage at the site in hot, wet, humid and dusty conditions. In addition, the imported Equipment shall also be satisfactorily packaged for moist tropical ocean shipment. Where necessary, heavy parts shall be mounted on skids so that cable slings for handling can readily be attached. Where it is unsafe to apply external slings to a package, attached slings shall be provided and shall project through the package so that attachment can readily be made.

In order to keep the damage to non-water proof Equipment during the transportation at minimum level, the Contractor and/or supplier is required to put an umbrella mark on every package of the Equipment.

In order to accelerate the dispatch of the Equipment to the site, the Contractor is required to arrange packaging of the Equipment in such a manner that a complete set of one unit shall be packed in package(s) or crate(s) with indication of designated substation but each individual package or crate shall contain the Equipment for only one unit or part of a complete set of one unit or otherwise as directed in the Instructions for Packaging attached at the end of Section E. General Conditions.

For Power Transformer and Shunt Reactor, in addition, all accessories, which are packed in aforesaid manner shall be contained in a container per transformer except for transformer insulating oil, radiators and conservator including other accessories which for dimensional reason after packaging are unable to be contained in the said container. However, spare parts shall be contained in a separate container per each shipment or Contract to be awarded. The containers to be used shall become the property of EGAT. The dimensions of containers shall be as follows : -

<u>Container Dimensions</u>	<u>Door Dimensions</u>
Height 2.59 m.	Height 2.28 m.
Width 2.44 m.	Width 2.33 m.
Length 6.05 m.	

In addition, details of Equipment and substation destination per container shall be identified in Bill of Lading.

Detailed breakdown prices for spare parts of Equipment shall be also indicated in the invoice.

Prior to delivery of all Equipment, packaging details shall also be submitted to EGAT for approval.

The cost incurred for repair or replacement of any damages to the Equipment due to improper packaging shall be at the Contractor's expense.

Each individual package or crate shall be clearly and plainly tagged or marked for identification as follows:

EGAT, THAILAND

PROJECT NAME : \_\_\_\_\_

CONTRACT NO. : \_\_\_\_\_

SUBSTATION : \_\_\_\_\_

CASE NO. : \_\_\_\_\_

ITEM NO. : \_\_\_\_\_

DESCRIPTION : \_\_\_\_\_

EGAT'S SERIAL NO. : \_\_\_\_\_ (if any)

In addition to this, the following instructions shall be observed :

- a. Each box, crate, case, bundle or piece of loose Equipment shipped must show the following information clearly marked on its body :
  1. Gross weight in kilograms
  2. Net weight in kilograms
  3. Dimensions in centimeters
- b. All boxes, crates, cases, bundles, loose pieces, etc. must be marked consecutively from No. 1 upward throughout all shipments to completion of the order without repeating the same number.
- c. The packing list must indicate whether shipment is partial or complete, and shall incorporate the following information on each container, etc., according to its individual shipping number:
  1. Export case markings
  2. Case number
  3. Container number (for Power Transformer and Shunt Reactor)
  4. Item number
  5. Gross weight and net weight in kilograms
  6. Dimensions in centimeters
  7. Complete description of Equipment
  8. EGAT's serial No. (if any)

#### **E-15. Clearance and Weight Limitations**

The largest unloading facilities at Bangkok Wharf are 35 metric ton cranes. Lifts heavier than 35 tons will have to be handled by ocean freighter on-board lifting equipment. Ocean freighters of the 10,000 tons class regularly calling at Bangkok Wharf have off-loading capacities to handle 50 tons.

The largest unloading facilities at Laem Chabang Port are 30 metric ton cranes. Lifts heavier than 30 tons will have to be handled by ocean freighter on-board lifting equipment.

Generally, unloading at Thai Port and highway transportation are subject to the following limitations:

Dimensions	Limitations		
	Unloading at Bangkok Wharf/ Highway Transportation		Unloading at Laem Chabang Port/Maptaphut Port
Weight (tons)	60.0	>60.0-135.0	120.0
Width (meters)	3.5	3.5	4.5
Length (meters)	10.0	10.0	25.0
Height from Loading Platform (meters)	3.7	4.0	4.0

The Contractor shall therefore exercise due care to pack the Equipment to meet the above transport limitations.

For Power Transformer and Shunt Reactor, the shipping weight of the largest part is indicated in Ratings and Features.

#### **E-16. Shipment**

Shipment of Equipment from port of embarkation to the final port of discharge shall be effected by using Thai vessels through the sea freight forwarder appointed by the Contractor. The Contractor is required to notify EGAT of the name of the sea freight forwarder one (1) week prior to shipment.

According to the regulations of *the Maritime Promotion Division*, Marine Department (as amended from time to time), shipments by non-Thai vessels can be made after receipt of permission granted by *the Maritime Promotion Division*, Marine Department as requested by the Contractor.

The Contractor is, therefore, required to immediately contact *the Maritime Promotion Division*, Marine Department for such permission with supporting documents of the case thereof for arrangement of the permission in advance.

The Contractor shall follow all other regulations stated in the Mercantile Marine Promotion Act B.E. 2521 and the regulations of *the Maritime Promotion Division*, Marine Department (as amended from time to time).

The Contractor shall be liable for any and all costs and expenses, losses and/or damages suffered by EGAT as a result of the Contractor's failure to comply with such regulations.

For more information, the Contractor may contact *the Maritime Promotion Division, Marine Department at telephone No. 66 2233 1311-8 extension 387 and facsimile No. 66 2639 4778, <https://maritimepromotion.md.go.th/>*

All imported Equipment shall be shipped on Conference Line or on seaworthy oceangoing vessels which are members or associate members of the International Association of Classification Societies (IACS) and ISM Code Certified Vessels. Vessels over fifteen (15) years of age shall not be used for shipment under this Contract unless they : -

- a) have been used for the carriage of general cargo on an established and regular pattern of trading between a range of specified ports and do not exceed twenty-five (25) years of age, or
- b) were constructed as containerships, vehicle carrier or double-skin open-hatch gantry crane vessels (OHGCs) and have been continuously used as such on an established and regular pattern of trading between a range of specified ports, and do not exceed thirty (30) years of age.

Shipment shall be made under deck except for such Equipment which for dimensional reasons cannot be stowed in the vessels hold. In case Equipment cannot be stowed in the vessel hold, permission shall be obtained from EGAT prior to loading such Equipment on deck. Such approval shall not be unreasonably withheld. The Contractor shall in any case be responsible for proper packing for protection of such Equipment loaded on deck of the vessel. Shipment of all Equipment by dry cargo container will be accepted, but all the incidental expenses shall be borne by the Contractor.

For shipment of Equipment under this Contract, transshipment is allowed.

Any delicate Equipment, materials, instruments and tools including but not limited to computers, electronic parts, etc., shall be shipped by airfreight. The Contractor shall be responsible for proper packing for protection of such Equipment loaded on cargo hold of the aircraft.

Air freight shipment to airport of disembarkation in Thailand shall be effected through the air freight forwarder appointed by the Contractor. The Contractor is required to notify EGAT of the name of the air freight forwarder one (1) week prior to shipment.

#### **E-17. Documents Required for Each Shipment**

##### **a. For Seafreight**

For accounting procedure, the Contractor is required to send to EGAT the bill of lading, invoice and master packing list immediately by *letter submitted electronically or by electronic mail (E-mail)* but not later than three (3) Days after the Equipment are actually loaded free on board (FOB Vessel) at the port of Shipment.

One (1) original negotiable bill of lading, three (3) original signed invoices and packing lists shall be mailed directly to EGAT by express airmail within four (4) working days after the date of departure of the ocean-going vessel from the port of shipment.

Two (2) original negotiable and five (5) copies of non-negotiable bill of lading, ten (10) original signed invoices and three (3) copies of packing lists shall be submitted to EGAT through the Bank within the time as specified in the letter of credit. - This requirement is applied only in case payment is made by letter of credit.

##### **b. For Airfreight**

For accounting procedure, the Contractor is required to send to EGAT the airway bill, invoice and master packing list immediately by *letter submitted electronically or by electronic mail (E-mail)* but not later than three (3) Days after the Equipment are actually loaded on the air carrier at the airport of departure.

Three (3) original signed invoices and packing lists shall be attached to the airway bill and dispatched together with the airfreight shipment.

One (1) copy of airway bill, two (2) original signed invoices and packing lists shall be sent directly to EGAT by courier within four (4) working days after the date of departure of the carrier from the airport.

Two (2) copies of airway bill, ten (10) signed invoices and three (3) copies of packing lists shall be submitted to EGAT through the bank within the time as specified in the letter of credit. - This requirement is applied only in case payment is made by letter of credit.

To act in accordance with the rules and regulations of the Customs Department of the Kingdom of Thailand, as well as to enable EGAT to expedite clearing the Equipment from the Customs House accordingly, the following declarations, other than regular statements, have to be made in English in the invoice for any transaction concluded with EGAT.

- a. Country from which Equipment is purchased as well as country of origin; if the Equipment is produced in the country or group of countries where there are trade agreements between such country or group of countries and the Kingdom of Thailand, preferential treatment on import duty and taxes for importation of the Equipment is required;
- b. Electricity Generating Authority of Thailand as consignee and Thailand as consigning country
- c. Date and Number of Contract;
- d. Name of Project, if any;
- e. Marking and numbers, as well as gross weight and volume;
- f. Details of Equipment, i.e. names, kinds, qualities, quantities, net weights, and other particulars as available for each type including trademarks or other symbols of such Equipment. If there are no trademarks or symbols, the invoice shall indicate "no trademarks", "no symbols", as the case may be;
- g. Selling price or value of Equipment per unit expressed in the type of currency under transaction and representing actual price or value of Equipment as stated in the price schedules or price breakdown, as the case may be;

If the Contractor fails to specify the price or value of Equipment according to the Contract in the invoice prepared for shipment, the Contractor shall be held responsible for the following:

1. In case of over value or price of Equipment stated in the invoice, the Contractor shall be responsible for reimbursement to EGAT for the import duty and taxes (excluding value added tax) collected by the Customs Department and the insurance premium (excluding value added tax) on the over value or price of Equipment as well as interest. Value added tax imposed in connection thereto shall be EGAT's responsibility. The Contractor shall also refund to EGAT the amount of over value payment as well as interest. The interest to be applied under this Article shall be Minimum Overdraft Rate announced by Krung Thai Bank plus two (2) (MOR+2) percent calculated from the date of EGAT's payment of the over value payment, import duty and taxes as well as insurance premium until the date of the Contractor's settlement of the same in full.
2. In case of under value or price of Equipment stated in the invoice, the Contractor shall be responsible for reimbursement to EGAT the surcharges imposed on additional import duty and taxes at the rate currently established by

the Customs Department as well as interest (if any) and also shall be responsible for compensation to EGAT for cost incurred in repair or replacement of the damaged Equipment which is not covered by insurance due to under value or price of Equipment stated in the invoice.

- h. Other expenses:
  - 1. Packing charges (if any)
  - 2. Insurance premiums (if insured)
  - 3. Freight
  - 4. Others (if any)

The Contractor shall, at the time of shipment, prepare and submit a certificate of origin(s) for the Equipment required as per point a. above together with the invoice and other shipping documents for EGAT to obtain the benefit from preferential treatment on import duty and taxes for importation of the Equipment from the country or group of countries where there are trade agreements between such country or group of countries and the Kingdom of Thailand. For each shipment, all items of Equipment requiring certificate of origin shall be included in only one (1) certificate of origin except as otherwise specified in any trade agreement. The trade agreements shall include but not be limited to the following:

- 1. Common Effective Preferential Tariff (CEPT) Scheme for the ASEAN Free Trade Area (AFTA);
- 2. Agreement between the Kingdom of Thailand and Japan for an Economic Partnership; and
- 3. Agreement between the Government of the Kingdom of Thailand and the Government of the People's Republic of China on Accelerated Tariff Elimination under the Early Harvest Programme of the Framework Agreement on Comprehensive Economic Cooperation between ASEAN and China.

If the Contractor advises EGAT in writing before shipment that it is unable to provide a certificate of origin to EGAT, the Contractor shall be responsible for all costs incurred including but not limited to reimbursement to EGAT for the excess amount of the import duty and taxes (except value added tax) paid by EGAT to Customs Department.

Further to the above, if the Contractor delays to provide a proper certificate of origin to EGAT, the Contractor shall be responsible for all costs incurred including but not limited to reimbursement to EGAT for the storage charges and the interest on the excess amount of import duty and taxes (except value added tax) paid by EGAT to the Customs Department at the rate of Minimum Overdraft Rate announced by Krung Thai Bank plus two (2) (MOR+2) percent calculated from the date of EGAT's payment of import duty and taxes up to the date of receipt of the excess amount of import duty and taxes refund from the Customs Department.

However, if the Contractor fails to provide such proper certificate to EGAT, the Contractor shall be responsible for all costs incurred including but not limited to reimbursement to EGAT for the storage charges and the excess amount of import duty and taxes (except value added tax) paid by EGAT to the Customs Department as well as interest on the said excess amount of import duty and taxes at the rate of Minimum

Overdraft Rate announced by Krung Thai Bank plus two (2) (MOR+2) percent calculated from the date of EGAT's payment of import duty and taxes up to the date of acknowledgement that the certificate cannot be issued in conformity with requirement of the Free Trade Agreement.

The Contractor is also required to study the existing trade agreements and any new trade agreement between the Kingdom of Thailand and a country or group of countries published in the website of Customs Department ([www.customs.go.th](http://www.customs.go.th)) and/or Ministry of Commerce ([www.moc.go.th](http://www.moc.go.th)), and ask for more information from EGAT in order that EGAT can obtain the benefit from preferential treatment on import duty and taxes for importation of the Equipment from the country or group of countries where there are trade agreements between such country or group of countries and the Kingdom of Thailand.

Fullest conformity with the requirements of the Customs Department of the Kingdom of Thailand mentioned above is essential as a condition precedent.

Unless by force majeure, failure to furnish EGAT with these shipping documents and the certificate of origin within the specified period and strictly in accordance with conditions stipulated above thereby causing impossibility of making prompt customs clearance of the Equipment from Thai Port, the Contractor shall, upon receipt of the EGAT's notice, reimburse EGAT for go down rent / storage charge and other expenses arising from or in consequence of the nonconformity with the above specified requirement.

#### **E-18. Force Majeure**

The Contractor shall not be in default under this Contract because of any delays in delivery or in completion of the Work on the separable parts thereof which delays are caused by force majeure; provided, that the Contractor shall notify EGAT in writing of the cause of any such delay within fifteen (15) Days after the end of the event which results in the delay. Upon receipt of any such notice of delay, EGAT will promptly ascertain the facts and the extent of the delay and will extend the time for the delivery and assembly of the Equipment or the time for completing the Work when, in the opinion of EGAT, the delay is caused by force majeure or the findings of fact to justify an extension. EGAT's decision shall be binding on the Contractor, subject to the provision of Article E-31. Dispute Resolution included in these General Conditions.

"Force Majeure" shall be defined as any event, the happening or pernicious results of which could not be prevented even though a person against whom it happened or threatened to happen were to take such appropriate care as might be expected from him in this situation. (Normal rains, inundation, dearth of water, and the overturning or sinking of barges in canals, rivers, or streams and similar events shall not be considered as force majeure).

**E-19. Transportation Insurance**

Transportation insurance from the port of shipment/from the Contractor's premise(s) to EGAT's Store and/or EGAT's site will be under the responsibility of EGAT.

**E-20. Transfer of Title**

The title of ownership for the Equipment furnished under this Contract shall be passed to EGAT at the time the Equipment is actually loaded onto the vessel at the port of shipment, or into charge of the air carrier at the port of departure, or at the time the Equipment is actually delivered ex-works and the Contractor's statement or delivery order confirming delivery of the Equipment ex-works has been certified by EGAT's representative. However, this transfer of title shall not be construed as an acceptance of the Equipment. The Contractor shall continue to be responsible for the quality and performance of the Equipment, and for their compliance with the Specifications as well as any loss, theft or damage of the Equipment during the course of execution of the Contract, until final acceptance of the Work by EGAT and the fulfillment of the guarantee provision of the Contract.

**E-21. Changes and Extra or Omitted Work**

EGAT may at any time authorize changes in, additions to, or deductions from the Equipment to be furnished under the Contract. Changes, additions, or deductions shall be authorized only by written notice served by EGAT upon the Contractor and such notice shall be treated as an integral part of the Contract. Adjustments, if any, in the amounts to be paid to the Contractor by reason of any such change, addition, or deduction shall be determined by one or more of the following methods :

- a. by unit price contained in the Price Schedules
- b. by an acceptable lump sum or unit price proposal from the Contractor
- c. on a cost-plus limited basis not to exceed a specific limit. A cost-plus limited basis is defined as the cost of Equipment, labor, and insurance, plus fifteen (15) per cent of the said cost to cover superintendence, general expense, and profit.

No claim for an addition to the Contract Price shall be valid unless authorized as described in this Article. If the parties are unable to agree to the method to be employed in determining adjustments in the Contract Price, the method shall be determined by EGAT.

**E-22. Termination and Suspension of Contract**

EGAT may, by written notice sent to the Contractor, terminate the Contract, in whole or in part, at any time for its convenience. The notice of termination shall specify that termination is for EGAT's convenience, the extent to which performance of work under the Contract is terminated, and the date upon which such termination becomes effective.

The Equipment that are completed and ready for shipment within thirty (30) Days after the Contractor's receipt of notice of termination shall be purchased by EGAT at the Contract terms and prices. For the remaining Equipment, EGAT may elect :

- a. to have any portion completed and delivered at the Contract terms and prices and/or
- b. to cancel the remainder and pay to the Contractor an agreed amount for partially completed Equipment and for materials and parts previously procured by the Contractor.

**E-23. Default and Termination**

Should the Contractor :

- a. fail to furnish the Equipment or carry out the Work in accordance with this Contract; or
- b. refuse or fail to prosecute the Work or any part thereof which shall ensure its completion within the time specified in this Contract or any authorized extension of time by EGAT; or
- c. fail to furnish the Equipment and/or complete the Work or any part thereof within the time specified in this Contract or any authorized extension of time by EGAT; or
- d. commit any breach or fail to comply with any of the provisions of this Contract; or
- e. notify EGAT in writing that the Contractor is unable or unwilling to furnish the Equipment or complete the Work or any part thereof; or
- f. become insolvent or bankrupt or make an arrangement or composition with the Contractor's creditors or, being a corporation, go into liquidation whether compulsory or voluntary (except for the purpose of reorganization); or
- g. by himself or by any person on his behalf, give or offer any money or benefit of forbearance to any employee of EGAT and/or any employee of the Engineer who has duties or responsibilities in connection with the acceptance of the proposal or the making of this Contract;

then, in any of such events, the Contractor shall be in default under this Contract, and EGAT may at his sole discretion take any one or more of the following actions that it considers appropriate :

- (i) suspend payments under this Contract until the default has been rectified;
- (ii) cancel or terminate the Contract in whole or in part;
- (iii) take that part of the furnishing of Equipment or the Work, in respect of which the delay or default has occurred, out of the hands of the Contractor or any other person in whose control or possession it is;
- (iv) reduce the Contract Price by an amount equal to the reduction in value to EGAT of the Equipment as actually delivered.

The Contractor shall be liable for all losses and/or damages including but not limited to the increased installation costs and increased administrative costs, suffered by EGAT as a result of the Contractor's default. The Contractor shall have no claim for payment with respect to Work thereafter performed.

All such damages may be recovered by EGAT from the Contractor in any court of competent jurisdiction or, without prejudice to that right, by deduction from any money due or becoming due to the Contractor under this Contract, or from any security deposited, or, after use of the property and materials of the Contract for completion of the work, as provided in this Contract, such property and materials may be sold and the proceeds shall be applied to any remaining obligations of the Contractor.

#### **E-24. Indemnification by the Contractor**

The Contractor shall fully indemnify and hold harmless EGAT and its employees and officers from and against any and all suit, actions or administrative proceedings, claims (including any claim for copyright or patent infringement), demands, losses, costs, expenses (including attorney's fees and expenses) and damages of whatsoever nature except breach or default, in respect of death or injury of any person or loss of or damage to any property caused by any act or omission of the Contractor or the Contractor's own officers, directors, agents, employees, Contractors or Subcontractors arising in any manner whatsoever, except any injury, death or property damage caused by the negligence of EGAT, its contractors, employees, officers or agents.

**E-25. Limitation of Liability**

The liability of the Contractor to EGAT arising from default or termination under the Contract in aggregate shall not exceed the total Contract Price.

**E-26. Consequential Damages**

Neither party shall be liable to the other party for any indirect, incidental, consequential or punitive damages as a result of the performance or nonperformance of the obligations imposed pursuant to this Contract, unless such indirect, incidental, consequential or punitive damages are foreseen or could have been foreseen at the time of execution of the Contract.

**E-27. Vesting of Contract in Receiver**

If the Contractor shall compound with his creditors, or shall become bankrupt or insolvent, or carry on business under a receiver, or become incapable from any cause whatsoever of carrying out the Work, any such receiver or any person in whom by law the Contract shall become vested, shall forthwith give notice to EGAT of the fact that the Contract has become vested in it and shall take all reasonable steps to carry on the Work at a rate fulfilling the Contract requirements. Thereupon, if EGAT so desires, such receiver or other such person as aforesaid shall have the option, during the period of one (1) Month from the date when the Contract becomes so vested in it, of carrying out the Contract. In the event of the Work being stopped, this option shall be opened only for a period of fourteen (14) Days from the stoppage date. In the event of the receiver or such other person not electing to carry out the Contract or EGAT not approving the carrying out of the Contract by the receiver, the Contractor shall then be in default and EGAT may proceed in accordance with Article E-23. Default and Termination.

**E-28. Extension of Time**

If, by reason of any of the following :

- a. Negligence or default on the part of EGAT or its agents,
- b. Alteration in or addition to the Work,
- c. Suspension of the Work at the written direction of EGAT for reasons beyond the control of the Contractor,
- d. War, insurrection, riot or civil commotion or delay caused thereby,
- e. Strikes, not caused by the Contractor's management,
- f. Lawful order of civil or military authorities,
- g. Unusually natural calamities, acts of God,
- h. Any other unforeseen circumstance beyond the Contractor's control.

The Contractor claims that he has been unduly delayed in the progress of the Work, he shall make written request to EGAT for an extension of time for completion of the Work or any portion of it.

Should EGAT consider such claim to be valid, it will grant such extension of time as may seem reasonable to EGAT, without thereby prejudicing or in any manner affecting the validity of the Contract. No extension of time will be granted unless the Contractor makes the written request within fifteen (15) Days after the end of the event which results in the delay.

Other than claiming an extension of time for completion of the Work or any portion of it, the Contractor shall not have any further recourse or claim against EGAT, nor shall he have any right of action against EGAT for loss or damage suffered by reason of such delay.

**E-29. Failure to Meet Requirements**

EGAT shall have the right to require the Contractor to make any changes in the Equipment or Work covered by this Contract, which may be necessary in the opinion of EGAT, to make the Equipment or Work conform to the requirements of the Contract Documents, without additional cost to EGAT. Any defects in the Equipment or workmanship or other failure, to meet the requirements of the Contract, including errors and omissions on the part of the Contractor, which are disclosed prior to final payment or prior to acceptance by EGAT,

or after completion of all tests, whichever occurs at the later date, shall, if so directed by EGAT, be corrected or replaced promptly by the Contractor at the expense of the Contractor.

In case of replacement of Equipment due to non-conformity with EGAT's specifications and/or defects found prior to acceptance of Equipment by EGAT or replenishment for short pack or returning of repaired Equipment due to such defect, the Contractor shall, upon receipt of EGAT's written notice supported with the receipt issued by the relevant parties, be responsible for reimbursement of the expenses incurred for the following :

- All re-export charges (if any)
- Import duty and taxes
- Landing charges, rents and handling charges (ocean freight)
- Storage charges (air freight)
- Truck hire
- Labour charges

These expenses shall exclude value added taxes, which will be EGAT's responsibility.

The contractor shall be also responsible for reimbursement of Service charges for customs clearance (if any) including value added tax.

Any latent defects not disclosed prior to the date of final payment or prior to acceptance or after completion of all tests, whichever occurs at the later date, but disclosed within the guarantee period as specified in Article F-10.a., shall be corrected or replaced promptly by the Contractor at the expense of the Contractor, except that the cost of import duty and taxes, inland transportation and installation of the replacement parts for foreign supply Equipment, and the cost of inland transportation and the installation of the replacement parts for local supply Equipment will be borne by EGAT.

For Equipment specified in Data Sheet, in case EGAT, at its sole discretion, requires the Contractor to replace any defected Equipment, the Contractor shall replace the Equipment with the whole new set at its own costs and expenses including the cost of all re-export charges (if any), import duty and taxes, landing charges, rents and handling charges (ocean freight), storage charges (air freight), truck hire, labour charges, service charges for customs clearance, inland transportation and installation of the Equipment.

The Contractor shall extend the provisions of his liability to cover all repair and replacement parts furnished from the day immediately following the date of completion of such repair or replacement as follows:

<b>Time of Malfunctioning and/or Defect Found</b>	<b>Guarantee Period Extension</b>				
	<b>Equipment with 1-Year guarantee period</b>	<b>Equipment with 2-Year guarantee period</b>	<b>Equipment with 3-Year guarantee period</b>	<b>Equipment with 4-Year guarantee period</b>	<b>Equipment with 5-Year guarantee period</b>
<b>First Year</b>	For a new period of one (1) Year.	For a new period of two (2) Years.	For a new period of three (3) Years.	For a new period of four (4) Years.	For a new period of five (5) Years.
<b>Second Year</b>	n/a	For a new period of one (1) Year.	For a new period of two (2) Years.	For a new period of three (3) Years.	For a new period of four (4) Years.
<b>Third Year</b>	n/a	n/a	For a new period of one (1) Year.	For a new period of two (2) Years.	For a new period of three (3) Years.
<b>Fourth Year</b>	n/a	n/a	n/a	For a new period of one (1) Year.	For a new period of two (2) Years.
<b>Fifth Year</b>	n/a	n/a	n/a	n/a	For a new period of one (1) Year.

The Contractor shall, if required by EGAT in writing, search under the directions of EGAT for the cause of any defect, imperfection or fault appearing prior to the acceptance of Equipment or in the period of maintenance guarantee. Unless such defect, imperfection or fault shall be one for which the Contractor is liable under the Contract, the cost of the work carried out by the Contractor in searching as aforesaid shall be borne by EGAT. If such defect, imperfection or fault shall be one for which the Contractor is liable under the Contract, the cost of the work carried out in searching as aforesaid shall be borne by the Contractor and he shall in such case repair, rectify and make good such defect, imperfection or fault at his own expense.

**E-30 Operation or Use of Unsatisfactory Equipment**

If the operation or use of the Equipment proves to be unsatisfactory to EGAT, EGAT shall have the right to operate and use such Equipment until they can be taken out of service for correction by the Contractor of such latent defects, error, or omissions and for replacement in whole or in part, if correction is unsuccessful or infeasible. The period of such operation or use shall not exceed one (1) Year from the day immediately following the date of acceptance of Equipment by EGAT.

**E-31. Dispute Resolution**

Any dispute arising out of or in connection with this Contract, interpretation, breach, or termination thereof shall be settled by amicable discussion between authorized representatives of each Party. Either Party may at any time send a written notice to the other Party requesting for an appointment of authorized representative for a settlement of any dispute hereunder. The Parties agree to make diligent and good faith attempt to resolve such dispute in an equitable manner. If the authorized representatives of both Parties are unable to resolve such dispute within 30 Days after commencement of the discussion for dispute resolution or other extended period of time as mutually agreed by both Parties, either Party may file a lawsuit to the court having jurisdiction in Thailand for settlement of such dispute. Each Party agrees that the final court judgment shall be conclusive and binding upon the Parties.

Pending decision of the court, both Parties shall continue to perform their respective obligations under this Contract.

**E-32. Language and Numbers**

All drawings, designs, specifications, manuals, nameplates, markings, operating instructions, statements, schedules, notices, documents, and all written communications between EGAT and the Contractor, concerning this Contract, shall be in the English language and in the metric system of weights and measures unless otherwise specified.

**SPECIMEN OF GUARANTEE**

To :

Date

Electricity Generating Authority of Thailand  
Bangkruai, Nonthaburi, 11130

Thailand

Re : Performance Security for Contract No. \_\_\_\_\_

Gentlemen :

In accordance with the provision of the Contract for \_\_\_\_\_ No. \_\_\_\_\_ (hereinafter referred to as the Contract) the contents of which have been noted by us that Messrs. \_\_\_\_\_ (hereinafter referred to as the Contractor) has to deposit with Electricity Generating Authority of Thailand (hereinafter referred to as EGAT) a Performance Security for the proper and faithful performance of the Contract in the amount of \_\_\_\_\_ (in words : \_\_\_\_\_) which is \_\_\_\_\_ per cent, round up to the nearest whole number, of the total Contract Price, we, the \_\_\_\_\_ as instructed by the Contractor, agree unconditionally to irrevocably guarantee as primary Obligor, the payment to EGAT on its first demand, without whatsoever right of objection on our part and without its first claim to the Contractor, in the amount not exceeding : \_\_\_\_\_ (in words : \_\_\_\_\_) in the event the obligations expressed in the above mentioned Contract have not been fulfilled by the Contractor, giving EGAT the right of claim for penalty, damages, liquidated damages or any expenses for which the Contractor may become liable to EGAT under the Contract.

We further agree that no extension of time, change in, addition to or other modification of terms of the Contract or Work to be performed thereunder, or of the Specifications or other Contract Documents, which may be made between EGAT and the Contractor, shall in any way release us from any liability under this guarantee, and we shall thereby waive notice of any such change, addition or modification.

This Performance Security shall be valid and remain in full effect from the date of execution of the Contract until the issuance of the Acceptance Certificate by EGAT or the acceptance of Equipment deemed to be made by EGAT against submission by the Contractor of the Maintenance Security accepted by EGAT.

Yours very truly,

\_\_\_\_\_  
Authorized Signature

### Instructions for Packaging

Name of Equipment	Packed per complete set of one unit/units	Packed per Substation
1. Power Transformer	√(1)	-
2. Distribution Transformer	√(1)	-
3. Shunt Reactor	√(1)	-
4. Surge Arrester	√(1)	-
5. Current Transformer	√(1)	-
6. CC, CCVT, VT	√(1)	-
7. GIS	-	√
8. Shunt Capacitor Bank	√(1)	-
9. Power Circuit Breaker	√(1)	-
10. Disconnecting Switch	√(1)	-
11. AC/DC Dist. Board, LCUS, LRP	√(1)	-
12. Stationary Battery	√(1)	-
13. Lighting Fixture	-	√
14. Identification and Danger Notice Plate	-	√
15. Control and Protection System	√(1)*	-
16. Computerized Control System	-	√
17. Power Line Carrier	-	√
18. Teleprotection	-	√
19. Line Trap	-	√
20. Battery Charger	√(1)	-

- Note :
1. Number in parenthesis represents maximum number of complete set of one unit/units packed in an individual package or crate.
  2. \* In case of spare for control and protection system, such Equipment shall be packed per board, but in case of loose control and protection system, such Equipment of whichever substation shall be packed in the same package or crate of that substation.
  3. Other substation Equipment not mentioned shall be packaged in such a manner that it will not cause unreasonable expenses or delay to EGAT in distribution of such Equipment to the designated substation.
  4. Prior to delivery of all Equipment, packaging details shall be submitted to EGAT for approval.

DRAFT

**SECTION F**  
**SPECIAL CONDITIONS**

## **SPECIAL CONDITIONS**

### **F-1. Scope of Work**

The Contractor shall perform, furnish and deliver the Equipment as required by these Contract Documents.

For imported Equipment, Transportation from Thai Port to sites shall be EGAT's responsibility. However, the Contractor shall, at his own expenses and responsibility, perform unloading the Equipment at the port or airport of disembarkation in Thailand.

For local supply, Transportation from the Contractor's premises to the sites shall be EGAT's responsibility. However, the Contractor shall, at his own expenses and responsibility, perform loading the Equipment on EGAT's trucks or trailers at the Contractor's premises and shall be liable for all losses and/or damages to the Equipment as well as any expenses causing therefrom.

### **F-2. Responsibility of Contractor**

The Contractor shall be solely responsible for ensuring that the Work throughout is executed in the most substantial, proper and workmanlike manner, with the best quality materials and conforming to the best engineering practice for the operating conditions specified; the drawings and quality control are performed or made in accordance with the Contract; and services reasonably to be furnished though not specifically provided in the Contract are furnished; all to EGAT's entire satisfaction notwithstanding that certain portions of the work may be executed by the Subcontractor.

### **F-3. Cooperation with Other Contractors**

The Contractor, if required, shall exchange with other Contractor furnishing associated Equipment, all necessary drawings and other information required to insure the complete and proper design and manufacture of the Equipment to be furnished under these Specifications. One (1) copy of all drawings and correspondence, relating to information interchanged between Contractors, shall be sent to EGAT in Nonthaburi, Thailand.

**\*F-4. Supervision of Installation**

Subject to the desire and decision of EGAT, the Contractor may be required to furnish the services of qualified and experienced supervisor(s) who has at least three years experience on the particular Work required under the Contract and shall be the permanent employee of the manufacturer of the Equipment. For 230 kV (or lower) Power Circuit Breaker and 115 kV (or lower) Gas-Insulated Switchgear, the permanent employee of the representative of the manufacturer is acceptable, provided that such employee is certified by the manufacturer.

The scope of responsibility of the supervisor on behalf of the Contractor is as follows :

- a. Supervise and be responsible for the installation, erection, adjustment, field test and commissioning of the Equipment.
- b. Prepare formulation sheets for a check list, test sheet, release form and field report to be discussed with EGAT before performing the installation work.
- c. Submit four copies of report summarizing the work performance, from the beginning to the completion of the supervisory period, to EGAT within one month after finish the installation work or final inspection. The report shall include the following :
  1. Note on pending matter i.e. faulty and omitted equipment, performance deficiency etc.
  2. Problem concerning installation performance.
  3. Photographs showing progress of the installation work periodically until the work is completed.

The Contractor shall, in each and every instance, cooperate fully with the construction personnel installing and/or operating the Equipment and the Work, the operations of the supervisor shall be coordinated with the program of construction at the site as directed by EGAT.

The supervisor shall report at EGAT in Nonthaburi, Thailand, on the date designated by EGAT after a reasonable advance notice from EGAT, and shall remain until the Equipment have been in satisfactory operation for at least ten (10) working days as determined by EGAT, unless released earlier by EGAT.

The installation supervisor must be able to understand, speak, read and write the English language fluently. Should an interpreter be necessary, the cost of such interpretation service shall be at the Contractor's expense.

\*If installation supervisor is required as specified in Price Schedule, this provision shall apply to this Contract.

**F-5. Acceptance Tests**

After the Equipment have been installed and placed in satisfactory operation, they may be tested by and at the expense of EGAT to determine whether or not all requirements of these Contract Documents have been met and the Contractor's guarantees have been fulfilled. The Contractor will be permitted to have his representative present at his own expense. If the tests show that the requirements or guarantee have not been met, the Contractor shall, at his own expense, make all necessary corrections. Additional tests will then be made to demonstrate to EGAT's satisfaction the effectiveness of these corrections. These additional tests will be at the Contractor's expense. Unless the necessary corrections have been made, the conditions of the Contract shall be considered unfulfilled.

All tests will be performed in accordance with the latest applicable Test Codes, unless otherwise stated.

**F-6. Failure to Meet Performance Guarantees**

If EGAT elects to accept the Equipment which do not meet any performance guarantee or which do not meet other requirements of these Contract Documents, as may be determined by factory test, field test or operation under service conditions, appropriate adjustment will be made of the Contract Price for such Equipment; provided that no such adjustment will be made until after the Contractor has been given a reasonable opportunity to repair, improve, or replace defective Equipment or parts thereof wherever practicable.

**F-7. Acceptance Certificate**

When EGAT is satisfied with the Equipment or agrees to accept the Equipment under the provision of Article F-6. Failure to Meet Performance Guarantees and there are no major unsettled claims against the Contractor by EGAT, EGAT will issue a written Acceptance Certificate against submission by the Contractor of maintenance security(ies) as specified in Article F-12. Maintenance Security and effective for a period of time as specified in Article F-10.a.

The Acceptance Certificate will list all deficiencies and reservations as a result of the inspection and tests performed, if any.

The purpose of the maintenance security is to guarantee the proper functioning of the Equipment supplied by the Contractor with a provision that the effective period of the maintenance security shall automatically be extended in case that the obligations stipulated in Article F-10. Maintenance Guarantee are not fulfilled.

A form of maintenance security acceptable to EGAT is shown in Article F-12. Maintenance Security.

## **F-8. Payment**

Payment in foreign currency will be made in the currency or currencies in which the price has been stated in the price schedules. The Contractor has to inform EGAT the mode of payment he requires for payment for foreign currency portion together with detail of bank account No., beneficiary's name and address etc. If the Contractor requires the payment of foreign currency portion to be paid directly to the suppliers, he has to inform EGAT which portion of the Contract Price, as stipulated in the term of payment of the Contract, to be paid accordingly. In case the local Contractor requires foreign currency or currencies to be paid directly to him, payment of such foreign currency or currencies will be made to the local Contractor in Thai Baht by using the selling exchange rate published by the Bank of Thailand on the payment date.

In case the Contractor requires the payment of foreign currency portion to be made through letter of credit, EGAT will, if there is no fault or any delay caused by the Contractor, establish the letter of credit in the name of the Contractor or Suppliers not later than thirty (30) Days after signing the Contract. The Contractor shall be responsible for all bank charges inside and outside Thailand and including opening, amendment, reimbursing charges, payment commission, cable charges, discrepancy fee, acceptance commission and others (if any) arising from Letter of Credit.

Payment in local currency will be made directly by EGAT.

The Contractor or beneficiary has to inform EGAT by mailed letter or *letter submitted electronically or by electronic mail (E-mail)* immediately the date upon which he has received the original letter of credit *to be* opened in his favour.

Payment will be made in the following manner :

### **a. Payment for Equipment (except Spare Parts and Optional Items)**

#### **Foreign Supply**

1. Eighty (80) per cent of the Contract Price will be paid after delivery FOB Port of Shipment (FOB Vessel) on the basis of pro rata value of each shipment against presentation of invoices, shipping documents, EGAT's letters of approval for shipment and EGAT's letter of approval for test report\* of the relevant Equipment including EGAT's letter(s) of approval for final drawings only for Control and Protection Equipment.

\*Test report means the report of tests specified in Article E-13. Inspection and Tests.

2. Ten (10) per cent of the Contract Price of each Schedule will be paid against presentation of Drawing and Document Acceptance Certificate to be issued by EGAT to certify the receipt of all drawings and documents required from the Contractor under Article F-11. Drawings and Documents to be Furnished by Contractor for such schedule, provided that payment shall not be made until EGAT has received from the Contractor the original signed negotiable Bill of Lading and appertaining documents giving evidence of shipment of the main Equipment of that Schedule.
3. Ten (10) per cent of the Contract Price of each Schedule will be paid after the Equipment have been installed, tested and operated or used for a period of 30 Days and the acceptance of the said Equipment has been made by EGAT against presentation of Acceptance Certificate to be issued by EGAT and submission of maintenance security by the Contractor. EGAT will list the minor pending claim(s), if any, and payment will be made by deducting such claimed amount.

However, if, through no fault of the Contractor or of the Equipment, such installation, test and operation or use of the Equipment are delayed beyond a period of six (6) Months after complete delivery at Thai Port; payment of this ten (10) per cent will be made as soon as possible but not later than the ninth (9<sup>th</sup>) Month after complete delivery and it shall be deemed as if acceptance of Equipment is made by EGAT at the end of the said sixth (6<sup>th</sup>) Month and the guarantee period shall start therefrom against submission of maintenance security by the Contractor.

In case there is some minor claim(s) or minor fault of the Contractor, the payment of this ten (10) per cent shall be made by deducting such claimed amount and the guarantee period of this part will start after such minor claim(s) has been settled by the Contractor and acceptance of which has been made by EGAT.

### **Local Supply**

1. Eighty (80) per cent of the Contract Price will be paid on the basis of pro rata value of each delivery against presentation of the Contractor's statement or delivery order confirming the ex-works delivery of Equipment duly certified by EGAT's representative\*, EGAT's letters of approval for delivery and EGAT's letter of approval for test report\*\* of the relevant Equipment including EGAT's letter(s) of approval for final drawings only for Control and Protection Equipment.

\*EGAT's representative means the authorized EGAT's Store personnel to verify the quantity of Equipment according to the packing list to be delivered to the Site.

\*\*Test report means the report of tests specified in Article E-13. Inspection and Tests.

2. Ten (10) per cent of the Contract Price of each Schedule will be paid against presentation of Drawing and Document Acceptance Certificate to be issued by EGAT to certify the receipt of all drawings and documents required from the Contractor under Article F-11. Drawings and Documents to be Furnished by Contractor for such schedule, provided that payment shall not be made until EGAT has received from the Contractor the statement or delivery order and appertaining documents giving evidence of delivery of the main Equipment of that Schedule.
3. Ten (10) per cent of the Contract Price of each Schedule will be paid after the Equipment have been installed, tested and operated or used for a period of 30 Days and the acceptance of the said Equipment has been made by EGAT against presentation of Acceptance Certificate to be issued by EGAT and submission of maintenance security by the Contractor. EGAT will list the minor pending claim(s), if any, and payment will be made by deducting such claimed amount.

However, if, through no fault of the Contractor or of the Equipment, such installation, test and operation or use of the Equipment are delayed beyond a period of six (6) Months after complete ex-works delivery; payment of this ten (10) per cent will be made as soon as possible but not later than the ninth (9<sup>th</sup>) Month after complete delivery and it shall be deemed as if acceptance of Equipment is made by EGAT at the end of the said sixth (6<sup>th</sup>) Month and the guarantee period shall start therefrom against submission of maintenance security by the Contractor.

In case there is some minor claim(s) or minor fault of the Contractor, the payment of this ten (10) per cent shall be made by deducting such claimed amount and the guarantee period of this part will start after such minor claim(s) has been settled by the Contractor and acceptance of which has been made by EGAT.

**b. Payment for Spare Parts**

One hundred (100) per cent will be paid after complete delivery against presentation of invoices, shipping documents and EGAT's letter of approval for shipment for foreign supply or the Contractor's statement or delivery order confirming the delivery of Equipment ex-works duly certified by EGAT's representative\* and EGAT's letter of approval for test report\*\* of the relevant Equipment and the acceptance has been made by EGAT. The guarantee period shall start from the day immediately following the date of the acceptance of the Spare Parts.

\*EGAT's representative means the authorized EGAT's Store personnel to verify the quantity of Equipment according to the packing list to be delivered to the site.

\*\*Test report means the report of tests specified in Article E-13. Inspection and Tests.

**c. Payment for Optional Items**

Payment for Equipment

One hundred (100) per cent will be paid after complete delivery with presentation of invoices, shipping documents and EGAT's letter of approval for shipment and the acceptance has been made by EGAT. The guarantee period shall start from the day immediately following the date of the acceptance of Equipment.

Payment for Mechanical Operation Life Test (if any)

One hundred (100) per cent of the cost of the Mechanical Operation Life Test will be paid after the test has been performed successfully and test report has been accepted by EGAT.

**d. Payment for Field Test Cost**

One hundred (100) per cent of Field Test Cost will be paid after the test has been performed successfully and the test report has been accepted by EGAT.

**e. Payment for Installation Supervisor**

Payment for the services of the installation supervisor will be made within thirty (30) Days after his release by EGAT. Payment will be made on the basis of actual working man-days at the quoted cost per man-day up to a maximum equal to the total man-days quoted. For man-days exceeding the quoted total man-days, no payment shall be made by EGAT unless the Contractor can claim for any delays in

the progress of the work caused by EGAT. Any such additional man-days approved by EGAT shall be paid on the basis of the quoted man-day rate.

The number of quoted man-days shall include Sundays and shall cover a seven (7) day workweek, if required by the construction program. The working hours shall be forty-eight (48) hours per week, eight (8) hours per day, the working hours over 8 hours per day if requested by EGAT will be counted as overtime at 1½ times the regular hourly rate.

The amount to be paid for each Day for the services of the supervisor shall include for all salary, subsistence expense, insurance, compensations and personal expense of the supervisor, and all liabilities and responsibilities thereto. EGAT will pay for round-trip economy class air transportation for the installation supervisor between the Contractor's home office and Bangkok by the most expeditious and direct route on trip basis by draft after receipt of the Contractor's invoice supported with the used air ticket of such supervisor. The remission of immigration fees and taxes collectible by the Kingdom of Thailand shall not be paid by EGAT, as described in Article E-11. Fees and Duties.

*After each payment is made, the Contractor or beneficiary shall issue and submit the receipt to EGAT at e-mail : FFMS@egat.co.th within three (3) calendar days upon receipt of such payment. The details of receipt shall include but not be limited to the following:*

- *Company name and address*
- *The receipt date of payment*
- *Lists of Goods/Services the payment is made for*
- *Payment amount in numbers and in words*
- *Recipient signature*

#### **F-9. Liquidated Damages for Late Delivery of Equipment**

In the event of failure by the Contractor to make delivery of any Equipment within the time set forth in the Contract, plus any extension thereof authorized by EGAT as provided in the Contract, such failure shall be a default under the Contract for which the Contractor shall be liable for payment to EGAT as liquidated damages at the rate specified in Data Sheet.

Whenever any Equipment under any item is to be used together with other Equipment in other item as specified in Price Schedule as a complete set or unit, the Contractor shall make sure that they shall be shipped together as a complete set or unit. Failure on the part of the Contractor to comply with this requirement, the liquidated damages for late delivery of partial shipment shall be imposed on the Contractor for the whole amount of the Contract Price of such related items.

Notwithstanding, in case the Contractor fails to make delivery of minor part of any Equipment within the time set forth in the Contract and such late delivery does not have any effect to the performance of the Equipment, the Contractor shall be liable for payment to EGAT as liquidated damages at the rate of one-tenth of one (0.10) per cent of the total price of the minor part of the Equipment not timely delivered for each Day of delay. The price of such delayed minor part of the Equipment shall be determined by EGAT. EGAT shall, at his own discretion, determine whether such late delivery Equipment is the minor part and has any effect to the performance of the Equipment or not.

The payment of such liquidated damages shall not relieve the Contractor of his obligations to complete the Work under the Contract.

In case any Equipment is defective or does not conform to the requirements or specifications of the Contract where replenishment or correction or replacement must be made by the Contractor as per Article E-29. Failure to Meet Requirements, it shall be deemed that such Equipment has not yet been delivered unless such Equipment has been replenished or corrected or replaced, as the case may be, and delivered to EGAT at the delivery point specified in the Contract.

Payment of liquidated damages is contingent exclusively upon late delivery; in no case shall EGAT be required to substantiate any claim for payment of liquidated damages with proof of loss and/or damages. The liquidated damages shall be calculated for each Day of delay until the Equipment is delivered to EGAT excluding a period of time from the actual delivery date at the delivery point set forth in the Contract until the issuance of notification of defect or short pack or out of specification made by EGAT to the Contractor. This sum is payable regardless of the actual loss and/or damages incurred.

The Contractor shall not be liable for liquidated damages in the event of delay caused by force majeure.

#### **F-10. Maintenance Guarantee**

- a. The Contractor shall guarantee the proper functioning of the Equipment for a period as specified in Data Sheet from the day immediately following the date of acceptance of Equipment by EGAT; provided, however, that should any malfunctioning and/or latent defect in Equipment under normal use and service be found during the said period, and such malfunctioning and/or defective portion be repaired or replaced as stipulated in (c) and (d) hereinafter, then the guarantee period for such portion shall be extended from the day immediately following the date of completion of such repair or replacement as follows:

Time of Malfunctioning and/or Defect Found	Guarantee Period Extension				
	Equipment with 1-Year guarantee period	Equipment with 2-Year guarantee period	Equipment with 3-Year guarantee period	Equipment with 4-Year guarantee period	Equipment with 5-Year guarantee period
<b>First Year</b>	For a new period of one (1) Year.	For a new period of two (2) Years.	For a new period of three (3) Years.	For a new period of four (4) Years.	For a new period of five (5) Years.
<b>Second Year</b>	n/a	For a new period of one (1) Year.	For a new period of two (2) Years.	For a new period of three (3) Years.	For a new period of four (4) Years.
<b>Third Year</b>	n/a	n/a	For a new period of one (1) Year.	For a new period of two (2) Years.	For a new period of three (3) Years.
<b>Fourth Year</b>	n/a	n/a	n/a	For a new period of one (1) Year.	For a new period of two (2) Years.
<b>Fifth Year</b>	n/a	n/a	n/a	n/a	For a new period of one (1) Year.

The premium for the maintenance guarantee shall be paid by the Contractor.

- b. On the expiration of the maintenance guarantee period and if the Equipment is functioning normally, the Contractor shall thereafter be released of all obligations and responsibilities under the Contract and the maintenance security deposited in accordance with Article F-7. Acceptance Certificate, will be released and returned to the Contractor.
- c. If during the guarantee period EGAT finds any malfunctioning and/or defect in the Equipment, EGAT shall inform without delay the Contractor thereof, stating in writing the nature of the malfunctioning and/or defect, and the Contractor shall promptly commence to repair and make good or replace such malfunctioning and/or defect at the expense of the Contractor, except that the cost of import duty and taxes,

inland transportation and installation of the replacement parts for foreign supply Equipment, and the cost of inland transportation and the installation of the replacement parts for local supply Equipment will be borne by EGAT.

For Equipment specified in Data Sheet, in case EGAT, at its sole discretion, requires the Contractor to replace any defected Equipment, the Contractor shall replace the Equipment with the whole new set at its own costs and expenses including the cost of all re-export charges (if any), import duty and taxes, landing charges, rents and handling charges (ocean freight), storage charges (air freight), truck hire, labour charges, service charges for customs clearance, inland transportation and installation of the Equipment.

- d. If, after the repair or replacement performed in accordance with this Article, such Equipment continues to show malfunctioning and/or defect, EGAT may, at its option, demand further repair or replacement, and reserve the right to claim damages, if applicable, arising therefrom.
- e. If the Contractor fails to take action for starting up the necessary works for repair or replacement within fourteen (14) Days after receipt of EGAT's written notice of defect, the defect will be corrected by EGAT or any third party selected by EGAT at EGAT's discretion, and the cost of the corrections shall be on the responsibility and account of the Contractor.

In the event of an emergency where in the judgement of EGAT the delay resulting from giving formal notice would cause serious loss or damage which could be prevented by immediate action, defects may be corrected by EGAT or a third party chosen by EGAT without giving prior notice to the Contractor, and the cost of the corrections shall be paid by the Contractor. In the event such action is taken by EGAT, the Contractor will be notified promptly and shall assist wherever possible in making the necessary corrections.

#### **F-11. Drawings and Documents to be Furnished by Contractor**

EGAT reserves the right to require the Contractor to submit the drawings and documents listed in the tables attached at the end of this Section by the designated dates either by registered airmail for foreign mail and registered mail for local mail and/or by electronic files uploaded via document management system. However, cover letters shall be submitted in hard copy to EGAT.

After the requirement under this Article has been fulfilled by the Contractor, a Drawing and Document Acceptance Certificate will be issued by EGAT to certify the receipt of all required drawings and documents:

a. Drawings

- (1) Drawing Title and Sizes. The title of Contractor's drawing shall also include the followings :

ELECTRICITY GENERATING AUTHORITY OF THAILAND

EGAT's Contract No. \_\_\_\_\_

Item No. \_\_\_\_\_

Subs. Name \_\_\_\_\_

The sizes of the drawings except otherwise specified in the Specification shall be as follows :

<u>Size Designation</u>	<u>Dimensions in MM</u>	<u>Dimensions in Inches</u>
A0	841 x 1,189	(33.11 x 46.81)
A1	594 x 841	(23.39 x 33.11)
A2	420 x 594	(16.54 x 23.39)
A3	297 x 420	(11.69 x 16.54)
A4	210 x 297	( 8.27 x 11.69)

- (2) Reference Drawings and Catalogues. General drawings showing principal dimensions and weights of Equipment, including controlling dimensions which affect space and handling requirements.

- (3) Drawings and Data for Approval. The Contractor shall submit for approval checked detail assembly drawings including firm dimensions, foundation details and setting diagrams, physical size and weights of all principal parts, complete operating characteristics and ratings of Equipment, connection and schematic wiring diagrams, descriptive information and any other information sufficient to demonstrate fully that the Equipment to be furnished will conform to the requirements and intent of these Contract Documents.

Schematic diagrams shall indicate the operation and function of all electrical Equipment, accompanied, where necessary, with explanatory notes. Wiring diagrams shall show the external connection required, sufficient for EGAT to complete interconnection cable diagrams.

One print each of the drawings submitted for approval will be returned to the Contractor by EGAT or its authorized representative within thirty (30) Days after receipt at EGAT's office, marked either "Approved",

"Approved Except as Noted", or "Returned for Correction"/"Not Reviewed". The notations "Approved" or "Approved Except as Noted" will authorize the Contractor to proceed with the manufacture of the Equipment covered by such drawing, subject to the correction, if any, indicated thereon. When prints of drawings have been "Returned for Correction"/"Not Reviewed"., the Contractor shall make the necessary revisions on the drawings and shall within thirty (30) Days resubmit drawings for approval in the same manner as before.

Any manufacturing done before approval of the drawings will be at the Contractor's risk. EGAT shall have the right to require the Contractor to make any changes in the design which may be necessary, in the opinion of EGAT, to make the Equipment conform to the requirements and intent of these Contract Documents without additional cost to EGAT. Approval of the Contractor's drawings shall not be held to relieve the Contractor of any part of his obligation to meet all of the requirements of these Contract Documents or of the responsibility for the correctness of his drawings.

- (4) Reproducibles of all final approved drawings shall be made on mylar films.
- b. Report of Shop Test. The Contractor shall furnish certified copies of reports of all tests required of the manufacturer to show compliance with the applicable standards and specifications. The cost of all tests and reports shall be borne by the Contractor.
- c. Instruction Manuals. The Contractor shall furnish complete set of instruction manuals and all final approved drawings (if any) for erection, operation, maintenance and repair of the Equipment, and for identification of parts. The instruction manuals shall be combined, assembled and bound in binders. Each binder cover shall be stamped with proper identification indicating name of Equipment, manufacturer's name and address, EGAT's Contract number, manufacturer's reference, etc.

Prior to the assembly and submittal of the instruction manuals, a proof of the cover lettering and the table of contents shall be submitted in sufficient time for EGAT's acceptance without delaying submittal of the finished manuals.

The CD-ROM (Compact Disc-Read Only Memory) of final drawings, final documents, test report and instruction manual, if required, shall conform to the applicable International Standard Organization 9660 (ISO 9660) and have capacity of approximately 700 Mbytes.

The data in CD-ROM shall be created by the following software :

### Drawing

The Contractor shall submit all drawings created by CAD software as follows:

1. MICROSTATION software Version SE or
2. AUTOCAD software Version 2000

Any necessary information supporting the completion of reading files (such as special font etc.) shall be included in CD-ROM.

### Documents

The Contractor shall submit all documents in Adobe Portable Document Format File (PDF format) and also Program of Acrobat Reader in order to read the file completely in CD-ROM.

### Drawing/Document List

The Contractor shall submit the drawings/documents listing information in work sheets file provided by EGAT in CD-ROM in Microsoft Excel file format.

Drawing list of design drawings, as built drawings, manufacturing drawings shall also be submitted together with the drawings in the CD-ROM.

## **F-12. Maintenance Security**

The Contractor shall provide to EGAT prior to the issuance of the acceptance certificate and as a condition for the release of the payment of the last instalment as specified in Article F-8. Payment, maintenance security(ies) in the amount of ten (10) per cent, round up to the nearest whole number, of the total Contract Price or ten (10) per cent, round up to the nearest whole number, of each schedule, excluding the cost of installation supervisor and cost of test(s), guaranteeing the Contractor's performance of the provision of Article F-10. Maintenance Guarantee. The Contractor shall oblige himself to attend to and replace, during the period of maintenance, all malfunctioning parts and for repair of all defects noted in the Work and communicated to the Contractor in writing by EGAT. In case of extended guarantee of the repaired or replaced Equipment, the Contractor may request for return of the original maintenance security and submit a new maintenance security in the amount of ten (10) per cent, round up to the nearest whole number, of the Contract Price of Equipment under the extended guarantee.

The maintenance security shall be in the form of a cash deposit, or a cashier cheque issued by a local bank, or a bank guarantee or letter of guarantee issued only by a local bank or an acceptable financial institution in Thailand, or by a foreign bank counter-guaranteed by a local bank, and made payable to EGAT in the same currency as that of

the Contract. In case of a cash deposit or a cashier cheque, only Thai baht portion of the Contract Price can be made. EGAT may at its absolute discretion refuse to approve any maintenance security offered or may at any time, upon application by the Contractor, approve of the substitution for any maintenance security held under this Article by other maintenance security on such terms and conditions as may be approved by EGAT.

The conditions of guarantor's obligations in the maintenance security shall include, inter alia; the following :

1. The guarantor shall unconditionally guarantee, as primary obligor and not as surety merely, payment of any obligations, damages, liquidated damages, performance penalties, or expenses for which the Contractor may become liable to EGAT.
2. No extension of time, change in, addition to, or other modification of the terms of the Contract or Work to be performed thereunder, or of the Specifications or other Contract Documents shall in anyway release the guarantor from any liability under the maintenance security, and the guarantor shall thereby waive notice of any such extension of time, change, addition or modification.
3. The maintenance security shall be valid and remain in full effect from the date of acceptance of Work until all obligations on the part of the Contractor under the Contract have been fulfilled.

Unless and until an official receipt is issued in respect to a maintenance security deposit, EGAT will not recognize or accept any such deposit as fulfilling the requirements of this Article. Failure to deposit a maintenance security at the time specified above in this Article or such extended time as may be approved by EGAT shall be a breach of this Contract and EGAT may, at its discretion, retain the payment of the last instalment of the total Contract Price.

If any maintenance security furnished under this Article shall become unacceptable to EGAT, or if any guarantor shall fail to furnish reports as to guarantor's financial condition from time to time, as requested by EGAT, the Contractor shall promptly furnish such additional or alternative maintenance security as may be necessary to satisfy the Contract requirements for a maintenance security.

In the event of any default or breach of this Contract on the part of the Contractor, EGAT may convert into money any maintenance security which does not consist of money, and the proceeds shall be deemed to be a cash deposit under this Article. EGAT shall not be liable for any cost, expenses and/or loss resulting from the conversion of any maintenance security deposit into money as herein provided. The Contractor shall bear the cost of the maintenance security.

The maintenance security, in case of a bank guarantee, or letter of guarantee, shall be in conformity with the following specimen.

## SPECIMEN OF MAINTENANCE GUARANTEE

To :

Date :

Electricity Generating Authority of Thailand  
Bangkruai, Nonthaburi 11130  
Thailand

Re : Maintenance Security for Contract  
No. EGAT \_\_\_\_\_

Gentlemen :

In accordance with the provision of the Contract for \_\_\_\_\_ No. EGAT \_\_\_\_\_ dated \_\_\_\_\_ (hereinafter referred to as the Contract), the contents of which have been noted by us that Messrs. \_\_\_\_\_ (hereinafter referred to as the Contractor) has to deposit with Electricity Generating Authority of Thailand, (hereinafter referred to as EGAT) a Maintenance Security to guarantee the proper functioning of the \_\_\_\_\_ of the Contract as specified in Article F-10. Maintenance Guarantee in the amount of \_\_\_\_\_ (in words : \_\_\_\_\_) which is ten (10) per cent, round up to the nearest whole number, of the total Contract Price or ten (10) per cent, round up to the nearest whole number, of each schedule of the said Work, excluding the cost of installation supervisor and cost of test(s), we, the \_\_\_\_\_ as instructed by the Contractor, agree unconditionally to irrevocably guarantee as primary Obligor, the payment to EGAT at its first demand, without whatsoever right of objection on our part and without its first claim with the Contractor giving EGAT the right of claim for penalty, damages, liquidated damages or any expenses for which the Contractor may become liable to EGAT under the Contract.

We further agree that no extension of time, change in, addition to or other modification of terms of the Contract or work to be performed thereunder, or of the Specifications or other Contract Documents, which may be made between EGAT and the Contractor, shall in any way release us from any liability under the Maintenance Security, and we shall thereby waive notice of any such extension of time, change, addition or modification.

This Maintenance Security shall be valid and remain in full effect for a period of \_\_\_\_\_ (...) Year(s) from the day immediately following the date of the acceptance of Equipment. If necessary, this Maintenance Security shall be extended as specified in Article F-10. Maintenance Guarantee.

Yours very truly,

\_\_\_\_\_  
Authorized Signature



**Drawings and Documents to be Furnished by the Contractor**  
**(For All Equipment except Control and Protection Equipment)**

The Contractor shall submit by registered mail and/or by electronic files uploaded via document management system with the drawings and other documents listed below by the designated deadlines.

Should EGAT require the Contractor to submit the drawings and documents in electronic files via EGAT's document management system, the Contractor is also required to submit the drawings and documents in Print and CD-ROM at the number of copies listed in the parenthesis below.

Drawings/Documents	No. of copies		Deadline and Remarks
	P	CD-ROM	
Manufacturing and Delivery Schedule	1 (-)	- (-)	Within 60 Days after confirmation of Letter of Award of Contract
Quality Assurance Program ( If requested by EGAT )	1 (-)	- (-)	Within 60 Days after confirmation of Letter of Award of Contract
Drawings or Documents "FOR REFERENCE"	4 (2)	- (-)	Within 90 Days after confirmation of Letter of Award of Contract
Drawings or Documents "FOR APPROVAL"	4 (-)	- (-)	Within 60 Days for foundation, steel supporting structure (if any) and within 90 Days for others after confirmation of Letter of Award of Contract
Drawings or Documents "FOR REAPPROVAL"	4 (-)	- (-)	Within 30 Days after receipt of returned approval drawings for correction
Drawings and Documents "FINAL DRAWING or FINAL DOCUMENT"	4 (2) *4 (-)	- (-)	Within 30 Days after receipt of approved drawings
Final Design Data	4 (-)	- (-)	Within 150 Days after confirmation of Letter of Award of Contract
Test Procedure (Factory Test)	1 (-)	- (-)	Within 150 Days after confirmation of Letter of Award of Contract
Test Schedule (Factory Test)	1 (-)	- (-)	Not less than 60 Days before testing for foreign supply Not less than 30 Days before testing for local supply
Test Report (Factory Test)	1 (-)	- (-)	Upon completion of tests
Installation Instruction	9 (7)	5 (5)	60 Days before first shipment/delivery
Instruction Manuals	9 (7)	5 (5)	Before shipment/delivery

**Note :** P = Print Drawing or Document  
CD-ROM = Compact Disc-Read Only Memory with capacity of approximate 700 Mbytes conforming to ISO 9660

\*For Transmission Line Insulator, Hardware Assemblies and Line Accessories, Transmission Line Steel Tower, HTLS Transmission Line Conductor and Invar Transmission Line Conductor.

DRAFT

**SECTION G**  
**RATINGS AND FEATURES**

## G. RATINGS AND FEATURES

### G-1. Ratings and Features

The following Ratings and Features sheets are attached hereto and made a part of the Contract Documents :

<u>RF No.</u>	<u>Description</u>	<u>Page</u>
TX991A	Power Transformer	G2 – G4
SA8Y1A	Surge Arrester	G5
SA2D1A	Surge Arrester	G6

DRAFT



<b>Ratings and Features</b>	<b>Designed : via ECM system</b>	<b>Validated : via ECM system</b>	<b>Revision 1</b>	<b>Page 1/3</b>
<b>RF No. TX991A</b>	<b>Verified : via ECM system</b>	<b>Approved : via ECM system</b>	<b>Dated : 11/2/2026</b>	

- a. Type Auto-Transformer, Single Phase, Outdoor, Oil Immersed
- b. Type of Cooling ONAN/ONAF/ONAF
- c. Rated Frequency 50 Hz
- d. Rated Power  
 - HV 200/266.7/333.3 MVA [600/800/1000 MVA]<sup>#</sup>  
 - LV 200/266.7/333.3 MVA [600/800/1000 MVA]<sup>#</sup>  
 - TV 10/ 13.3/ 16.7 MVA [ 30/ 40/ 50 MVA]<sup>#</sup>
- e. Rated Voltage  
 - HV Side  $525/\sqrt{3}$  kV [525 kV]<sup>#</sup>  
 - LV Side  $242/\sqrt{3}$  kV [242 kV]<sup>#</sup>  
 - TV Side 22 kV [22 kV]<sup>#</sup>
- f. Nominal System Voltage  
 - HV Side 525 kV  
 - LV Side 230 kV  
 - TV Side 22 kV
- g. Highest Voltage for Equipment  
 - HV Side 550 kV  
 - LV Side 245 kV  
 - TV Side 24 kV
- h. Rated Insulation Level (BIL) of Winding  
 - HV Side 1550 kV  
 - LV Side 950 kV  
 - TV Side 150 kV  
 - Neutral 150 kV
- i. Rated Insulation Level (BIL) of Bushing  
 - HV Side 1550 kV  
 - LV Side 950 kV  
 - TV Side 150 kV  
 - Neutral 150 kV
- j. Bushing  
 - Material of Insulator Porcelain  
 - Creepage Distance of HV Side  $\geq 13750$  mm  
 - Creepage Distance of LV Side  $\geq 6125$  mm  
 - Creepage Distance of TV Side  $\geq 600$  mm  
 - Creepage Distance of Neutral  $\geq 600$  mm
- k. Connection of Windings in Three Phases Yn, a0, d1
- l. Positive Sequence Impedance at Rated Voltage (Single Phase MVA Base)  
 - HV Side to LV Side Tap 8L / Tap N / Tap 8R  
 16.3% / 16.5% / 17.5% (333.3 MVA Base)  
 - LV Side to TV Side (See Note 3) 212.0% / 212.0% / 212.0% (333.3 MVA Base)  
 - HV Side to TV Side (See Note 3) 235.4% / 235.6% / 236.3% (333.3 MVA Base)
- m. De-Energized Tap Changer -
- n. On Load Tap Changer  
 - Tapping Range Base on Rated Voltage  $\pm 10\%$  on HV Side with 1.25% Step  
 - Insulation Level (BIL)  $\geq 1050$  kV
- o. Temperature Class of Winding Insulation 120

<sup>#</sup> For three single phase transformers connected to form a three phases bank.

**Power Transformer  
Specification No. 711**



**Substation Electrical  
Equipment Engineering Department**

<b>Ratings and Features</b>	<b>Designed : via ECM system</b>	<b>Validated : via ECM system</b>	<b>Revision 1</b>	<b>Page 2/3</b>
<b>RF No. TX991A</b>	<b>Verified : via ECM system</b>	<b>Approved : via ECM system</b>	<b>Dated : 11/2/2026</b>	

- p. Winding Temperature Rise when Carrying Max. Continuous Rated Power
- Winding Average ≤ 60 °C
  - Winding Hot-Spot ≤ 75 °C
  - Top Oil ≤ 60 °C
- q. Average Sound Pressure Level at Rated Voltage and Frequency
- Without Fan ≤ 74 dB(A)
  - With Fan ≤ 76 dB(A)
- r. Surge Arrester, Station Class, Tank Mounted; Complete with Discharge Counter HV Side (see detail in RF - )
- Qty. per Phase None
  - Voltage Rating N/A kV
- LV Side (see detail in RF SA8Y1A)
- Qty. per Phase 1
  - Voltage Rating 192 kV
- TV Side (see detail in RF SA2D1A)
- Qty. per Phase 1
  - Voltage Rating 24 kV
- s. Bi-directional Wheels  With  Without
- t. Parallel Operation Requirement (between HV and LV side)
- Not Required
  - With Future Transformer or Each Other in the same Substation
  - With Existing Transformer in accordance with Dwg. No. \_\_\_\_\_ attached
- u. Bushing Current Transformer
- HV Side
- Qty. per Phase 1
  - Accuracy Class 5P20, 30 VA
  - Ratio 900-1350-1800/1 A
  - Thermal Current Rating Factor 1.0
- LV Side
- Qty. per Phase 1
  - Accuracy Class 5P20, 30 VA
  - Ratio 2000-3000-4000/1 A
  - Thermal Current Rating Factor 1.0
- TV Side
- Qty. per Phase ( On Y1 ) 1
  - Accuracy Class 5P20, 30 VA
  - Ratio 400-800/1 A
  - Thermal Current Rating Factor 1.0
- Neutral
- Qty. per Phase -
  - Accuracy Class -
  - Ratio -
  - Thermal Current Rating Factor -
- v. Max. Permissible Shipping Weight 150 tons (See Note 1)
- w. Max. Permissible Shipping Dimension 4.0 m × 10.0 m × 4.0 m (W×L×H) (See Note 1)
- x. Applicable Standards IEC 60076



<b>Ratings and Features</b>	<b>Designed : via ECM system</b>	<b>Validated : via ECM system</b>	<b>Revision 1</b>	<b>Page 3/3</b>
<b>RF No. TX991A</b>	<b>Verified : via ECM system</b>	<b>Approved : via ECM system</b>	<b>Dated : 11/2/2026</b>	

- Note :
- Exception to the weight and dimension limitation stated in Article : Clearance and Weight Limitations.
  - The positive sequence impedance from HV side to LV side shall have a tolerance of  $\pm 5\%$  of specified value.
  - The HV-TV and LV-TV impedance voltage shall be designed to limit tertiary fault level to  $\leq 500$  MVA (3 phase) during fault conditions. Calculation showing such fault limitation shall be included in Bidding document. External current limiting reactor are not acceptable.

Regarding the effect of different impedance voltage in HV-TV and LV-TV, the transformer shall be designed to be capable of connection with other manufacturer's units; especially, having successful combination as a transformer bank without any performance deterioration.

- Transformer shall be considered as transformer bank No.1 of which provision shall be made for future parallel operation upto 4 transformer banks according to drawing No. TP-E-10.12 "TYPICAL SCHEMATIC DIAGRAM OF FOUR-500/230 kV TRANSFORMER BANK PARALLEL OPERATION"
- The transformer shall be designed to withstand the following fault occurrence rates with the expected transformer life of 25 years.

<u>Current Intensity</u>	<u>Times/Year</u>
100 %	1
50 %	20
20 %	100

Where the 100 % current intensity means the maximum value of the short circuit current.

- Radiators shall be designed to be attached to the transformer tank. The radiator bank located on separated foundation from the transformer foundation is not acceptable.
- The physical arrangement of the terminal blocks for external connection in the phase control cabinet and common control cabinet shall be the same as arrangement in the existing transformer for convenient interchangeable purpose. The drawing of the physical arrangement of terminal blocks of the existing transformer will be submitted to the contractor after award of contract.
- The main tank of transformer transported from Thai port to site is strongly required to be placed on vehicle in an upright position. Uprighting of main tank when unloading at site shall not be accepted.
- In case of parallel operation with the existing transformer are required, the control schematic diagram of the existing transformer shall be submitted to the contractor after award of contract.
- Surge arrester shall be located on tank wide side to provide the electrical clearance with firewall.

**Surge Arrester  
Specification No. 741**



**Substation Electrical  
Equipment Engineering Department**

<b>Ratings and Features</b>	<b>Designed : via ECM system</b>	<b>Validated : via ECM system</b>	<b>Revision 0</b>	<b>Page 1/1</b>
<b>RF No. SA8Y1A</b>	<b>Verified : via ECM system</b>	<b>Approved : via ECM system</b>	<b>Dated : 21/10/2025</b>	

a. Type	Metal Oxide without series gaps
b. Class	Station Class
c. Rated Frequency	50 Hz
d. Nominal System Voltage	230 kV
e. Highest Voltage for Equipment	245 kV
f. Arrester Voltage Rating	≥ 192 kVrms
g. Insulator	<input checked="" type="checkbox"/> Porcelain <input type="checkbox"/> Polymer
h. Repetitive Charge Transfer Rating (Qrs)	≥ 2.4 C
i. Thermal Energy Rating (Wth)	8 kJ/kV
j. Rated Short Circuit Current	63 kA
k. Maximum Lightning Impulse Residual Voltage	440 kV crest @ 5 kA 470 kV crest @ 10 kA 515 kV crest @ 20 kA
l. Maximum Switching Impulse Residual Voltage	390 kV crest @ 0.5 kA
m. Minimum Creepage Distance	≥ 6125* mm
n. Discharge Counter	<input checked="" type="checkbox"/> Yes <input type="checkbox"/> No
o. Mounting	As price schedule
p. Line Terminals	4-Hole NEMA Pad,
q. Applicable Standard	IEC 60099-4

Note: \*Special Creepage Distance ; Base on 25 mm/kVmax.L-L

**Surge Arrester  
Specification No. 741**



**Substation Electrical  
Equipment Engineering Department**

<b>Ratings and Features</b>	<b>Designed : via ECM system</b>	<b>Validated : via ECM system</b>	<b>Revision 0</b>	<b>Page 1/1</b>
<b>RF No. SA2D1A</b>	<b>Verified : via ECM system</b>	<b>Approved : via ECM system</b>	<b>Dated : 21/10/2025</b>	

a. Type	Metal Oxide without series gaps
b. Class	Station Class
c. Rated Frequency	50 Hz
d. Nominal System Voltage	22 kV
e. Highest Voltage for Equipment	24 kV
f. Arrester Voltage Rating	≥ 24 kVrms
g. Insulator	<input checked="" type="checkbox"/> Porcelain <input type="checkbox"/> Polymer
h. Repetitive Charge Transfer Rating (Qrs)	≥ 2.4 C
i. Thermal Energy Rating (Wth)	8 kJ/kV
j. Rated Short Circuit Current	63 kA
k. Maximum Lightning Impulse Residual Voltage	61 kV crest @ 5 kA 65 kV crest @ 10 kA 73 kV crest @ 20 kA
l. Maximum Switching Impulse Residual Voltage	49 kV crest @ 0.5 kA
m. Minimum Creepage Distance	≥ 600* mm
n. Discharge Counter	<input checked="" type="checkbox"/> Yes <input type="checkbox"/> No
o. Mounting	As price schedule
p. Line Terminals	4-Hole NEMA Pad,
q. Applicable Standard	IEC 60099-4

Note: \*Special Creepage Distance ; Base on 25 mm/kVmax.L-L

DRAFT

**SECTION I**  
**SPECIFICATIONS**

## I. SPECIFICATIONS

### I-1. Specifications

The following specifications are attached hereto and made a part of the Contract Documents :

<u>Specification No.</u>	<u>Description</u>	<u>Page</u>
711 (Jan. 2026)	Oil filled Power Transformer	711.1 – 711.78
741 (Sept. 2025)	Metal Oxide Surge Arresters	741.1 – 741.8

## Specification No 711

### Oil filled Power Transformer

**711-1 General.** This specification covers the general requirements for design, manufactures, test and supply of the outdoor, oil-filled power transformer.

The specific ratings, characteristics and the special requirements and features of the transformer not cover herein are given in the accompanying Ratings and Features sheet.

**711-2 Materials and Workmanship.** All materials shall be new and shall be the best available for the purpose used, considering strength, ductility, durability and suitability for the intended service and best engineering practice. Workmanship shall be of the highest grade and in accordance with the best modern standard practice.

**711-3 Service Conditions.** All materials shall be suitable for installation and use at an altitude of 1000 m or less in a tropical climate with a maximum ambient temperature of 45°C, maximum 24 hour average temperature of 40°C, yearly average temperature of 30°C and 100% relative humidity without corrosion, deterioration or degradation of performance characteristics.

**711-4 Codes and Standards.** All equipment, materials, devices, fabrication and testing shall conform to the codes, specifications and standards listed below and all applicable codes, specifications and standard referenced therein.

ANSI	American National Standards Institute
ASME	American Society of Mechanical Engineers
ASTM	American Society for Testing and Materials
AWS	American Welding Society
IEC	The International Electrotechnical Commission
IEEE	The Institute of Electrical and Electronics Engineers
NEMA	National Electric Manufacturers Association
TIS	Thai Industrial Standards

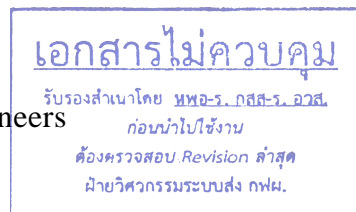

24 กุมภาพันธ์ 2569

All threaded parts requiring external connection shall have metric screw and pipe threads. All internal parts may have threads in accordance with the established specification in the country of manufacturer.

It is the intent that all equipment, materials, devices, fabrication and testing shall conform to the application codes, specifications and standards even though there

are not specifically noted herein. Equivalent codes, specifications and standards established and approved in the country of equipment or material manufacturer may be used subject to EGAT's approval. If this election is made, the Bidder shall so state and include in his bid the governing codes, specifications, and standards proposed together with an itemized list of specific deviations from the requirements of codes, specifications and standards referenced herein.

The latest issue of all codes, specifications and standards shall govern.

The most stringent requirement, in the event of code, specification or standard conflict, shall govern. This specification shall govern in the event of discrepancies between it and applicable codes, specifications and standards.

**711-5 Working Stresses** - The design of all components, particularly those subject to shock or stress reversal, shall incorporate reasonable factors of safety in all cases.

**711-6 Design and Construction**

**711-6.1 Tank.** Each transformer shall be provided with a steel case of substantial construction and a welded main cover. The tank shall be capable of withstanding, without leakage or permanent distortion of an internal gas pressure of 1 kg/cm<sup>2</sup> (14.22 lb/in<sup>2</sup>) and a vacuum of 760 mm of mercury and shall be designed and constructed for full vacuum filling in the field. The maximum design positive and negative operating pressures shall be indicated on the nameplate. All valves, fittings and piping shall be designed and constructed for such vacuum filling. The tank cover shall not be designed to retain water.

The piping shall be arranged to have a slope of not less than 0.05 radians (2.86 degrees) from the horizontal and shall be upward toward the conservator. The highest point of every pocket in the tank and attachments in which gas may accumulate shall be connected together by piping and shall be connected through the Buchholz relay.

The tank shall also have suitable jacking pads, pulling eyes and lifting lugs. All the jacking pads, pulling eyes and skid base shall be designed and constructed for possibly moving the complete assembly transformer on roller in either direction. The jacking pads shall be located at the tank side wall of at least 40 cm above transformer base and shall be suitable for EGAT's jack having base dimension of 30 cm x 25 cm in rectangular. The jacking pads and lifting lugs shall be welded on longer tank sides. The tank shall be provided with a fabricated structural steel skid base to allow skidding or moving on roller in either direction. The tank shall have four (4) jacking pads for applying force at the same time. The base and skids shall be fabricated as one piece with the distance between skids shall be in the range of 95 to 150 cm (center to center) for 115 kV and below Transformer and 120 to 150 cm (center to center) for 230 kV and above Transformer. A flat base plate is not acceptable.

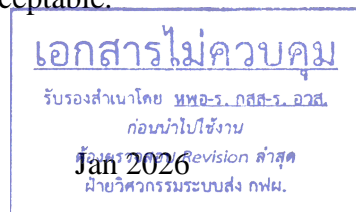

The position of center of gravity for transformer under transportation condition and complete assembly condition shall be clearly marked on the transformer tank, the axes of center of gravity for both conditions shall be marked at skid base of all four sides of transformer. The distance between center of gravity under transportation condition and the center line of transformer shall not be more than 150 mm.

**711-6.2 Core.** Cores shall be constructed of high quality, non-aging, annealed, high permeability silicon steel. The steel shall be in thin laminations. Both sides of each sheet shall be insulated with a durable, high temperature inorganic coating. The cores shall be rigidly clamped with positive locking devices to insure adequate annealed, high permeability silicon steel. The steel shall be in thin mechanical strength to support the windings and prevent shifting of laminations during shipment, and also to reduce vibration to a minimum during operation. Cores shall be grounded at one point and two (2) bushings shall be provided for possible measuring the core insulation of 2.5 kV from top of the tank cover without lower the oil. One bushing for core and another bushing for core clamp.

**711-6.3 Windings.** The design, construction, and treatment of windings shall give proper consideration for all service factors, such as high dielectric and mechanical strength of insulation, coil characteristics, uniform electrostatic flux distribution, prevention of corona formation, and minimum restriction to free oil circulation.

Winding conductor shall be free from burrs, scale and splinters and shall be uniformly insulated. In every case, each conductor strand shall be insulated by varnish to avoid the risk of sulfur attack in contact with insulating oil. Bare conductor (without insulating paper and/or enamel) is not acceptable.

The hoop compressive stress of the winding which can be buckled due to the pressure during the short circuit condition shall be limited to the following:

- a) In case of no cooling duct between turns in the disk coil, the average hoop compressive stress shall not be more than 35% of proof stress with permanent elongation of 0.2% ( $\sigma_{0.2}$ ) of used copper.
- b) In case of cooling duct being inserted between turns, the stress shall be controlled at the outermost turn with the same limitation as above item (a).
- c) In case of epoxy resin being used for bonding conductor, the same condition as above item (a) and (b) shall be considered except that the stress shall be limited to not more than 50% of proof stress with permanent elongation of 0.2% ( $\sigma_{0.2}$ ) of used copper.

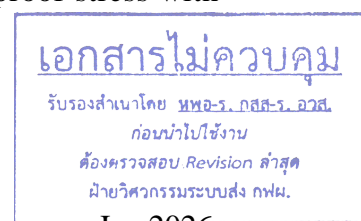

Nevertheless, other factors concerning the transformer strength such as conductor size, bonding quality for continuous transposed conductor (CTC), etc. shall be considered by the manufacturer as well. Moreover, the manufacturer shall be fully responsible for the proposed transformer design.

All insulation shall be of uniform quality and void free. Current carrying joints or splices shall be welded or braced, properly formed and finished and insulated for the basic insulation level.

The insulating pressboard offered shall be the products of the manufacturers as shown on the list attached.

The completed winding assembly shall be securely held in place so that there will be no derangement or deformation due to stresses during shipment. Applied pressure for winding clamping shall be controlled by applied torque or pressure on clamping bolts. Torque value or pressure on clamping bolts and the coil height shall be recorded and submitted for our reference.

**711-6.4 Core and Coil Assembly.** The completed assembly of core and coils shall be dried in a vacuum sufficient to insure elimination of air and moisture within the solid insulation to less than 0.5% water by weight. After the drying process, the assembly shall be immediately impregnated with dry oil. Vacuum may be applied either in a special tank or in the transformer tank.

The core and coil assembly shall be adequately blocked and braced in the transformer tank to prevent any movement of the assembly during handling and shipment. Shipping clearance limitations may necessitate shipment of the transformer on its side. Any internal blocking or bracing which is to be removed from the transformer at its destination shall be colored a bright color such as red or yellow.

**711-6.5 Oil Preservation.** The conservator shall be provided with a rubber bag type oil preservation system with dehydrating breather to prevent the outside air from coming into contact with the transformer oil. This shall be accomplished by the use of a flexible nitrile air cell vented to the outside air through a desiccant, such as silica gel, in a weather tight breather. The breather desiccant container shall be fabricated with metallic container equipped with clearly visible side glasses and located for safe replacement, refill and maintenance can be made while the transformer is energized. The silica gel shall be nontoxic type.

The conservator shall be equipped with a combination of oil drain and oil filling valve, a combination of vacuum valve and upper filter-press connection. The conservator shall be capable of withstand without leakage or permanent distortion an internal pressure of 1 kg/cm<sup>2</sup> (14.22 lb/in<sup>2</sup>) and a vacuum of 760 mm of mercury and shall be designed and constructed for vacuum filling in the field.

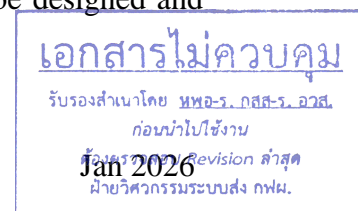

Lifting eyes shall be provided on the conservator tank.

**711-6.6 Cooling Equipment.** Each transformer shall be designed with a sufficient number of radiators or cooling units to operate as a self-cooled unit and with or without forced cooled ratings as specified in Ratings and Features sheets. The forced cooled ratings will be obtained by the use of single stage fans (Class ONAN/ONAF) two stages fans (Class ONAN/ONAF /ONAF) or two stages, fans and oil pumps (Class ONAN/ONAF/OFAF). In case of OFAF cooling class, the transformer shall be designed that the Static Electrification problem shall not occur.

Fans and oil pumps shall be automatically controlled by a transformer winding temperature relay. Cooling control equipment shall be installed in the transformer control cabinet.

Each radiator, unless it is made of stainless steel, shall be of galvanized with painted and shall be connected to the transformer tank through radiator valves, so that any individual radiator may be removed without taking the transformer out of service. Gasket joints shall be provided between the valves and machined steel flanges welded to the tank and to the radiator. An oil-tight blank flange shall be provided for each connection, for use when radiators are detached. Each radiator shall be designed and constructed for vacuum filling independently in the field and shall have a lifting eye, oil drain valve with flange, and a combination of vacuum flange and a vent. If cooler units furnished are of the finned-tube type, tubes, fins, and tube sheets shall be of corrosion-resistant material and shall be designed to permit replacement of individual cooler tube groups.

The loss of any fan or any oil pump shall not reduce the output of the transformer by more than 10%, with temperature rises maintained within specified limits. The verification of this condition shall be submitted for approval.

The oil pumps and motors shall be mounted on the transformer and shall have ample capacity to circulate the oil through the complete transformer and radiators and to maintain the temperature rise within the limit specified. The oil pumps shall be of the centrifugal type and shall be direct connected to the motors. The oil pumps and motors shall be completely oil-immersed and shall operate without the use of packing glands. Oil pump shall be located so that any pump may be removed or maintained with complete safety while the transformer is energized. Valves shall be located between the transformer tank and the pump and between the pump and radiator or cooler to permit pump removal without draining the oil from the transformer and radiator or cooler. The valves used shall be a type which offers minimum restriction of oil flow and shall be provided with an adjustable stuffing gland. Simultaneous operation of oil pumps, either starting or stopping, shall not cause any misoperation of the fault pressure relay and/or Buchholz relay. An oil flow indicator, with alarm contacts,

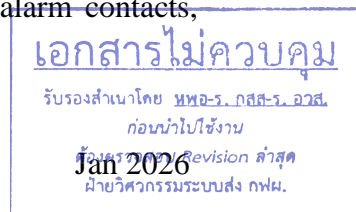

shall be furnished with each pump assembly to indicate normal pump operation and direction of oil flow.

Fan motors shall be of the totally-enclosed design. All motor shall be suitable for operation on a 3-phase, 4-wire, 400/230 Vac, 50 Hz power supply. Fan motor leads shall be totally enclosed in flexible liquid-tight and/or cable tray.

**711-6.7 Bushings.** All bushings shall be resin-impregnated paper-insulated bushing for capacitance graded bushing and shall be solid type for non-capacitance graded bushing. For resin-impregnated paper-insulated bushing, the inner space between insulator and condenser body, if any, must not be filled with oil or gas. The material, electrical and mechanical characteristics shall comply with the applicable requirements of the latest IEC 60137.

All porcelain used in bushing shall be wet process, homogeneous, and free from cavities or other flaws. The glazing shall be uniform in color and free from blisters, burns and other defects. The color of all porcelain insulators shall be chocolate brown. All porcelain parts of 230 kV and below bushing shall be one piece. The porcelain housing for 69 kV and above bushing shall be cemented to the flange.

All bushings shall be mounted so that their installation and removal may be accomplished without draining the oil below the top of the windings. The phase spacing between any bushings shall not be less than 800 mm.

For Single Phase Transformer;

The arrangement of the bushings on the transformer shall be located as shown on the drawing of "Layout for installation of 500 kV Single Phase Transformer" attached. The low voltage bushing shall be arranged for vertical take-off. The tertiary bushings shall be arranged side-by-side, on a line parallel to the centerline of the transformer separating the high side and low side. Both the low voltage and tertiary voltage bushings shall be top cover mounted.

For Three Phase Transformer;

The bushings shall be located in such a way that when facing against the high voltage side of the transformer, H<sub>1</sub> bushing shall be on the right-hand side, followed by H<sub>2</sub> and H<sub>3</sub> toward the left-hand side respectively. X<sub>1</sub>, X<sub>2</sub>, X<sub>3</sub> bushings of the low voltage side shall be directly opposite H<sub>1</sub>, H<sub>2</sub>, H<sub>3</sub> bushings respectively. Neutral bushing and tertiary bushing, if required, shall be located as shown on the drawing of "Bushings Location for Three Phase Transformer" attached.

Package for Long Term Storage Bushing; (For Resin Impregnated Paper (RIP) Condenser bushing)

Spare bushing(s) shall be packed in the long-term storage tank. The storage tank shall be filled with dry transformer oil and equipped with oil sight glass.

เอกสารเมคคอม  
รับรองสำเนาโดย นพอ.ร. กสส.ร. อวส.  
ก่อนนำไปใช้งาน  
Revision ล่าสุด  
Jan 2026  
ฝ่ายวิศวกรรมระบบส่ง กฟผ.

Other bushings shall be packed in the long-term storage bushing (at least 24 months) by the instruction manual. The manual shall be submitted together with the tender document during the bidding.

## 711-6.8 Control Cabinets

### a) General

Each transformer shall be furnished complete with a tank mounted control cabinet in which shall be housed all cooling control devices; LTC control devices and accessories, control power air circuit breakers and annunciator, all as described herein; auxiliary alarm relays; and bushing current transformer short-circuiting type terminal blocks.

Each cabinet shall be of the dead-front type with gasket, vertically hinged and adequately braced front door(s). The doors shall have a latching handle complete with a key lock and key cover and 180 degree opening, complete with latching device to secure the door(s) in the full open position. Center-opening double doors shall be provided where the door width exceeds 760 mm. Double door cabinets shall not have latching or bracing devices between the doors that would prevent easy access to the enclosure interior.

The interior of the front door of the transformer control cabinet for a three-phase transformer, and of the common control cabinet for a single-phase transformer, shall be provided with a holder suitable for storing one complete set of transformer drawings and instruction books. The cabinets shall have baffled louvers complete with insect screens.

Each control cabinet shall be installed at an elevation such that control and selector switches and pushbuttons are located approximately 1.0 m above the operator's standing level. All cabinet installed control and selector switches and push buttons shall be dead-front mounted.

All control cabinets shall be weatherproof, rigidly framed and fabricated for 3 mm minimum thickness steel sheet.

Each control cabinet shall be provided with a gasket removable plate at the bottom for field conduit, armoured cable or cable tray drilling. The bottom of the control terminal cabinet shall be equipped with removable blank cover plate suitable for equipment above. If it is conduit, four (4) 88.9 mm diameter knock out type holes suitable for 3 inches rigid steel conduit shall be provided.

### For Single Phase Transformer

A separate mounted transformer bank common control cabinet complete with supporting frame or members for installation on the transformer bank center phase foundation shall be furnished. This cabinet shall house all transformer bank common control and

เอกสารไม่ควบคุม  
ก่อนนำไปใช้งาน  
ต้องตรวจสอบ Revision ล่าสุด  
ฝ่ายวิศวกรรมระบบส่ง กฟผ.

24 กุมภาพันธ์ 2569

indication devices and accessories including, but not limited to, LTC control devices and accessories, air circuit breakers, relays, and the common transformer annunciator, all as described herein; and auxiliary tripping and alarm relays.

All galvanized bolts, nuts and washers, including foundation anchor bolts, required for complete assembly and erection of the common control cabinet shall be furnished.

For Common control cabinet, terminal blocks shall be arranged by transformer phase (i.e., phase A-B-C) from left to right or from top to bottom when viewing the terminal blocks.

#### b) Wiring

All wiring for control power supply and for remote control, indication, alarm and tripping shall be connected to terminal blocks provided in this cabinet. All wiring shall be tin coated copper conductor, stranded, minimum voltage classification of 600 V with high temperature PVC insulation. Hinge wire shall be extra flexible Class K stranding.

All wiring shall be not less than 2.5 mm<sup>2</sup>, except that all current transformer secondary winding wiring shall be not less than 6 mm<sup>2</sup> for secondary current 5 A and 4 mm<sup>2</sup> for secondary current 1 A. The cross-sectional area of internal wiring in the LTC motor drive mechanism shall be in accordance with the manufacturer's standard. All alarms, contacts and control and indication devices shall be completely wired.

Every point of terminal block and wire shall be assigned a designation, with identical designation on each corresponding terminal block and wire as following format:

The designation on each wiring end shall consist of both origin and destination designations which separated by '/' symbol. The origin designation shall always be indicated on the side adjacent to where the wiring is terminated while the far side shall always indicate the destination designation of the wiring. Depending on the arrangement of terminal block, device and wiring, wire designation on both ends of the same wiring may be different.

**เอกสารไม่ควบคุม**  
รับรองสำเนาโดย พพอ-ร. กสส-ร. อวส.  
ก่อนนำไปใช้งาน  
ต้องตรวจสอบ Revision ล่าสุด  
ฝ่ายวิศวกรรมระบบส่ง กฟผ.

24 กุมภาพันธ์ 2569

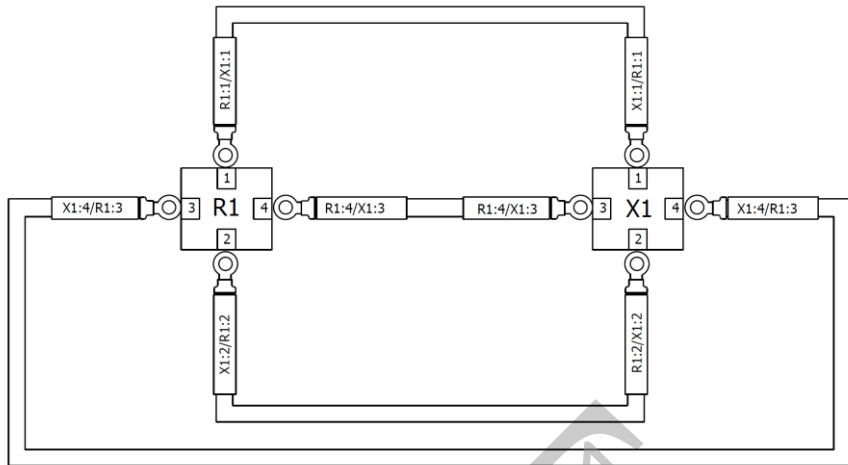

- The letter direction of wire mark shall be read from left to right (for horizontal wiring) and bottom to top (for vertical wiring).
- The terminal number of terminal block shall be arranged from top to bottom and left to right.

This same designation shall also be indicated in the schematic and wiring diagrams. As a rule, a designation will not change until the wire is terminated or connected to other equipment. All wiring shall be designated at both ends by printing on wire designation sleeves. Wire designation shall be by permanent method unaffected by heat, solvents, or steam, and not easily dislodge. Approximately 20% of spare wire designation sleeve shall be furnished. Adhesive labels shall not be acceptable.

Insulated ring tongue crimp type terminal shall be used for current transformer. Insulated ring tongue, ferrule, or cord-end crimp type terminals shall be used for other device and terminal block wire connections.

Within the control cabinet shall be mounted a terminal board to facilitate completing the wiring to external circuits. A barrier shall be provided in the terminal cabinet to separate the 400V circuits and their control from lower voltage circuits. Splices or tee connection shall not be permitted for wiring connection in control cabinet.

The terminal board shall consist of terminal blocks of 600 V molded block type with insulating barrier between terminals. Both ends of the low voltage wires shall be terminated by compression type terminal lugs. The interior wiring shall be terminated to the terminal block. Each terminal block shall have marking strip, and shall be equipped with the compression type terminal lugs for 4 mm<sup>2</sup> or larger cable to make connection with outgoing cables. The terminal blocks shall be provided with ten (10) percent but not less than ten (10) additional terminals as spares besides the necessary number. Two (2) or more external wires shall not be connected in one (1) terminal.

**เอกสารไม่ควบคุม**  
 รับรองสำเนาโดย นพอ.ร. กสส-ร. อวส.  
 ก่อนนำไปใช้งาน  
 24 กุมภาพันธ์ 2569  
 Revision ล่าสุด  
 ฝ่ายวิศวกรรมระบบส่ง กฟผ.

Terminal block connections shall be arranged for a maximum of one external wire connection per point. Terminal blocks for external wiring shall have the size suitable for termination of the following cables:

For AC supply	: 2x35 mm <sup>2</sup>
For DC supply and	: 2x6 mm <sup>2</sup>
For CT leads	
- Secondary current 5 A	: 2x6 mm <sup>2</sup>
- Secondary current 1 A	: 2x4 mm <sup>2</sup>
For others and spares	: 2x4 mm <sup>2</sup>

The terminal blocks for AC circuit and the terminal blocks for DC circuit shall be separately grouped as well as the AC terminal blocks shall be covered with transparent plastic box.

All EGAT external alarm, control, indication and control power connections, except as indicated herein, will terminate in this control cabinet. The turn-key Contractor shall be responsible for all interconnections between the individual transformer control cabinets and the common control cabinet. For a supply Contract, EGAT shall be responsible for these external connections. In all cases, the sufficient quantity of cable completed with metallic cable tray for interconnections between individual transformer control cabinet and common control cabinet, drawings showing all cabinet interconnections shall be provided by transformer manufacturer. Each external wire shall be identified at each end with a metallic cable tag placed over the armoured cable or cable tray.

The Contractor shall furnish, and install where practicable armoured cable or cable tray for wiring all control, protective accessories and bushing current transformers. Short sections of flexible, waterproof conduit may be used for shock mounting. The armoured cable or cable tray shall be suitable connected to the transformer accessories and bushing current transformers and shall be connected to a control cabinet upon each transformer tank.

A minimum clearance of 125 mm shall be provided between terminal blocks to facilitate wiring.

### c) Copper ground bus

A 25 mm wide x 6 mm thick or 30 mm wide x 5 mm thick copper ground bus with 4 mm drilled and tapped holes shall be provided with insulation support bushing and properly installed to the enclosure near the bottom of each control cabinet for current transformer secondary and control cable shield grounding. The holes shall be spaced on 20 mm center lines minimum. A 10 mm long binding head screw or screw with bronze spring washer shall be provided in each hole. The ground bus shall have a minimum of ten (10) holes and screws for control cable shields and shall be solidly connected to ground terminal.

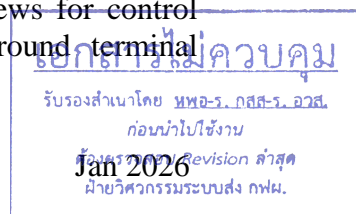

connector located outside of the cabinet. EGAT shall have the option of specifying additional ground bus holes and screws at the time of drawing approval without additional cost to EGAT. The ground terminal connector shall be clamp type suitable for No 4/0 AWG copper stranded conductor which is directly connected to grounding system and provided at one end of each cabinet ground bus.

**d) Space heater, Lighting and Outlet**

Sufficient space heater and lighting with door control switch shall be provided in the control cabinet. The space heater circuit shall be as follows:

- a) A set of space heater is operated continuously to maintain the temperature rise inside the cabinet within 5°C above the ambient temperature.
- b) A set of space heater is operated with temperature supervised humidity control.

A space heater with temperature supervised humidity control shall be provided in each control cabinet and connected to the 230 V, 50 Hz single-phase power supply. The heaters shall be located to promote warm air circulation to prevent cabinet interior condensation while avoiding insulating material and other component accelerated deterioration.

Lighting, completed with control switch and two sets of 20 A, 250 V, two-pole three wire grounding device universal outlets for connection to the EGAT furnished single phase alternating current supply, shall be furnished and installed in each control cabinet.

**711-6.9 Terminal Pad.** Each equipment terminal for connecting to the line or other equipment shall be equipped with a suitable terminal pad unless otherwise specified. The terminal pad shall be provided with 14.3 mm (9/16 in) diameter holes with 45 mm (1-3/4 in) spacing between the centers of each hole in accordance with the NEMA Standards CC1, 4 holes arrangement shall be used for systems rated 230 kV and below and 6 holes (2×3 bolt pattern) arrangement shall be used for 500 kV systems.

The terminal pad shall be of high conductivity copper or aluminum alloy and, unless it is made of aluminum alloy, shall be plated with hot flowed electro-tin to a thickness of not less than 0.0127 mm (0.0005 in).

**เอกสารไม่ควบคุม**  
รับรองสำเนาโดย นพอ-ร. กสส-ร. อวส.  
ก่อนนำไปใช้งาน  
ต้องตรวจสอบ Revision ล่าสุด  
ฝ่ายวิศวกรรมระบบส่ง กฟผ.

**711-6.10 De-energized Tap Changer (DETC).** An externally-operated tap changer, operated only when the transformer is de-energized, shall be furnished with each transformer if specified in Ratings and Features sheet. To prevent misoperation of the de-energized tap changer while the transformer is still energized, one set of interlocking contact for tripping off the circuit breaker with the provision that the circuit breaker shall be tripped before the possible operation of the de-energized tap changer shall be provided.

The tap changers shall be designed so that they can be operated conveniently, and shall include an operating hand wheel or handle, indicating pointer and dial, and means for locking the tap changer in any desire position. The operating hand wheel or handle shall be provided with steel enclosure and padlock to protect against the unauthorized operation. The locking device shall be arranged to prevent locking the tap changer in an intermediate position. The mark to indicate the position of the tap changer shall also be provided at the transformer tank where the tap changer mechanism shaft enters the transformer tank, so that if the shaft linkage is broken or loosen the tap position is evident.

For Single Phase Transformer

The circuit breaker trip contact shall be wired to the auxiliary tripping and lockout relay via transformer control cabinet and common control cabinet terminal block points.

**711-6.11 On Load Tap Changer (LTC).** The on load tap changer, if specified in Ratings and Features sheet, shall be the original design and shall have the contact life of not less than 500,000 numbers of tap change operation and shall have the changeable number of operations at maximum rated through-current of LTC provided without hot oil filter unit unless otherwise specified elsewhere of not less than 50,000 times or 5 years, whichever is earlier, without any inspection.

The LTC shall be of high speed resistor type provided either at the high voltage or low voltage side as specified in Ratings and Features sheet.

The LTC shall regulate the output at full capacity at all taps. Regulation through any auxiliary transformer is not acceptable

The LTC shall consist of separated diverter switch and tap selector, however for 50 MVA power transformer and below, selector switch type (combining the duties of diverter switch and tap selector) is acceptable. The diverter switch or selector switch shall have independent compartment and oil conservator from transformer main tank.

In case the in-tank selector switch (non-vacuum type) is provided, the hot oil filter unit shall be furnished and connected to the selector switch. The pumping operation shall be fully automatically via contacts from the motor drive unit during each tap change operation. The operating time for the pump shall be set relative to the oil volume of the tap changer oil compartment to ensure that during each pumping operation, the volume of



เอกสารนี้ควบคุม  
รับรองสำเนาโดย นพอ.ร. กสส-ร. อวส.  
ก่อนนำไปใช้งาน  
Jan 2026 Revision ล่าสุด  
ฝ่ายวิศวกรรมระบบส่ง กฟผ.

tap changer oil shall be passed several times through the filter. The pressure gauge with alarm contact shall be provided to indicate the excessive pressure in the filter tank for filter insert replacement.

The transition resistor shall be designed to withstand at least a number equivalent to one cycle (the movement of the tap changer from one end of its range to the other and return to its original position) of uninterrupted operation, therefore manual continuous consecutive tap-change of one cycle shall be possible without overheating or damaging the transition resistor. The mark to indicate the position of tap changer shall be provided for each pole of LTC.

The LTC equipment shall provide a range of regulation and percentage of each step as specified in the Ratings and Features sheet. The tap positions of LTC shall have no idle tap, meaning each operation of the LTC shall result in a voltage change to the next step, either higher or lower. Local and remote control and indication for the LTC equipment shall be furnished. The local control equipment shall be installed in a transformer control cabinet. The control devices furnished shall have accuracy class as defined in the IEC60076-21. In any case, if shipment of the LTC chamber is separated from the main tank, connection of these parts shall be made by welding to form into one unit.

The pressure relay or oil flow relay shall be provided to prevent excessive pressure in the diverter switch enclosure in case a fault should occur, causing vaporization of the oil and a normally open contact shall also be provided to trip the main circuit breaker at a pre-set pressure or flow rate. The design of the tap changing equipment shall be such that the mechanism will not stop in any intermediate position, however, if the mechanism through faulty operation does stop in an intermediate position, full load must be carried by the transformer without injury to the equipment. The mechanical position indicator shall be equipped in the motor drive cabinet. The LTC motor shall be designed to be of step control, which in any case the operation shall be of step by step.

The manufacturer of motor drive mechanism shall be the same as load tap changer.

The on load tap changer shall be equipped with but not limited to the following accessories:

- a) LTC pressure relay or oil flow relay with a normally open trip contact for each diverter switch compartment.
- b) Pressure relief device with a normally open alarm contact for each diverter switch compartment.
- c) Oil-level gauge with a low-level normally open alarm contact.
- d) Silica-gel breather for LTC conservator. Sizing is depended on manufacturer design, but shall not be less than 3.0 kg.

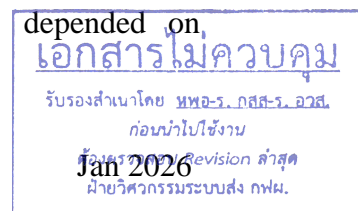

e) Valve with flange connection complete with blank cover plate of at least for the following items;

- Connecting valve for LTC conservator to LTC compartment
- Oil drain valve for LTC conservator and each LTC compartment
- Oil filling valve for LTC conservator and each LTC compartment

The drain and filling valves shall be extended down and located for ease in operating from ground level.

f) Fully detachable lifting device for LTC in-tank type, such as chain hoist and support etc., fixed on the transformer tank for lifting off the diverter switch or selector switch of the LTC from transformer tank to the ground level. The lifting device shall be properly kept in the separated cabinet mounted at the transformer tank.

**711-6.12 Cable End Box.** The cable end box, if required, shall be rigid weatherproof type complete with cable entry at the bottom and cover fixed by bolt at the front of the box for easy access of power cable installation and inspection. The cable end box shall be made of steel sheet, the thickness of such steel sheet shall be at least 2.5 mm and shall be fixed rigidly to the transformer tank. Color of the box shall be the same as the transformer tank.

Transformer bushing with clamp type connectors shall be provided. Cable terminators suitable for power cable size as specified in Ratings and Features sheet and installed rigidly inside the cable end box and the ground terminal completed with connector suitable for ground lead (provided by Contractor) for grounding of copper tape shielding from cable terminators to ground terminal shall be provided.

**711-6.13 Sound Enclosure.** Each sound enclosure, if required, shall be outdoor and waterproof. Outside shall be of steel plate and frame with anti-corrosion painted. Sound absorbing materials can be used inside of the sound enclosure for additional attenuation. Necessary ventilation (intake and outlet ducts, cooling fans, etc.) can be provided to prevent heat dissipation of the sound enclosure.

Specific layout, accessories, test details and other requirements not cover herein are given in the accompanying Ratings and Features sheet.

**711-7 Short Circuit Capability** The transformer shall be designed and constructed to withstand the mechanical and thermal stress produced by external short circuit limited by the impedance of the transformer and system impedance. The transformer shall also withstand the fault condition occurring while the maximum system voltage maintained at the unfaulted terminals during the fault condition.

The duration of the short circuit current is limited to 2 s.

The system impedance at all tap voltage shall be obtained from the system fault capacity as specified below.

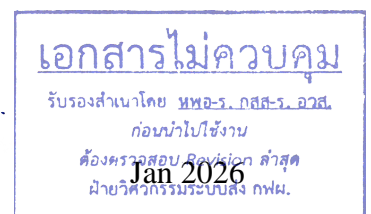

Nominal System Voltage (kVrms)	System Fault Capacity (MVA)
525	60,000
230	30,000
115	8,000
69	5,000
33	750
22	500
11	500

The transformer manufacturer shall at least take the following into consideration when calculating the short circuit current:

- All types of external short circuit such as three-phase fault, single line to ground fault, etc. shall be taken into consideration.
- The fault current produced by the short circuit shall be considered to be resulted from power feed from both HV and LV sides. (Exception for SVC, STATCOM and Floating Solar Project Transformer, the fault current shall be considered to be resulted only power feed from HV side.)
- The network ratio of zero and positive sequence component ( $X0/X1$ ) for HV and LV sides of the transformer, which will be used in calculation, shall be  $0.5 \leq X0/X1 \leq 3.0$ . (The severe case that have difference network ratio between HV and LV sides shall be considered.)
- The system voltage maintaining on transformer terminal shall not be less than the following:

Maximum tap	100% of tap voltage
Rated tap	105% of tap voltage
Minimum tap	105% of tap voltage

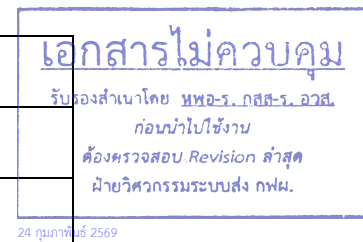

- The first-cycle asymmetrical peak current factor ( $K \times \sqrt{2}$ ) shall be calculated by using of  $x/r$  of the transformer in accordance with IEC Std. 60076-5.

Despite the fact that the designed calculation of transformer is definitely depended on the knowledge and technical know-how of the manufacturer, who shall also have full responsibility for the result of his design, EGAT will examine the transformer withstand by the enclosed formula as shown on “Requirement for Hoop Stress in Transformer” attached.

If EGAT found that the proposed transformer failed to comply with the specified criteria, the proposed transformer will be treated as a non-conformity EGAT's specification.

Detailed calculation showing all parameters of electro-mechanical stress and force results shall be submitted to demonstrate that the transformer as designed can withstand the effects of through faults both in magnitude and frequency. These data shall be compared to critical failure stress for each major failure mode such as inward radial hoop buckling, outward radial hoop stretching, conductor tilting, stress on spacer and coil end support force capability. The results shall include the magnetic leakage field plot.

DRYTEXT

**เอกสารไม่ควบคุม**

รับรองสำเนาโดย **ทพอ.ร.กสส.ร.อวส.**  
ก่อนนำไปใช้งาน  
ต้องตรวจสอบ **Revision** สำสุด  
ฝ่ายวิศวกรรมระบบส่ง กฟผ.

24 กุมภาพันธ์ 2569

### Definition of similar transformer

A transformer is considered similar to another transformer taken as a reference if it has the following characteristics in common with the latter:

- 1) Same type of main winding, for example layer, helical, disc or pancake coil;
- 2) For Core Type, the considered transformer shall meet the requirement as follow;
  - a) The relative stress (the ratio of actual stresses to proof stress with permanent Elongation of 0.2% ( $\sigma_{0.2}$ ) of copper) for Hoop Compressive / Tensile Stress shall not exceed the reference transformer.
  - b) The relative stress / forces other than specify in article (a) shall not exceed 110% of those relating to the reference transformer.
- 3) For Shell Type, the considered transformer shall meet the requirement as follow;
  - a) The relative stress (the ratio of actual stresses to proof stress with permanent Elongation of 0.2% ( $\sigma_{0.2}$ ) of copper) for Tensile / Compressive stress imposed on the conductor shall not exceed the reference transformer.
  - b) The compressive stress on spacer shall not exceed the reference transformer.
  - c) The relative stress / forces other than specify in article (a) shall not exceed 110% of those relating to the reference transformer.

The comparison forces and stresses in transformers accordance with Table A.1 or A.2, IEC 60076-5 shall be submitted together with tender document during the bidding.

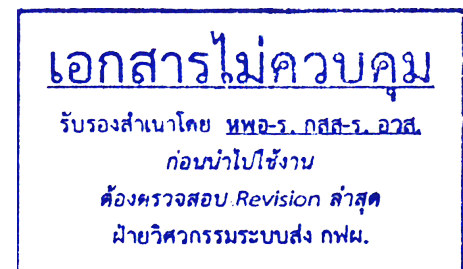

24 กุมภาพันธ์ 2569

## Requirement for Hoop Stress in Transformer

### 1. Hoop Compressive Stress Calculation (for Core Type Transformer)

Basically, the average hoop compressive stress in core type transformer with concentric winding is derived from:

Where

$$\sigma_H = \frac{F_{r(avg)}}{2\pi \cdot (Na_c)}$$

- |              |   |                                                                              |                            |
|--------------|---|------------------------------------------------------------------------------|----------------------------|
| $F_{r(avg)}$ | = | The average radial force generated by short circuit current and leakage flux |                            |
|              | = | $\frac{1}{2} \frac{\mu_0 NI}{H_w} \cdot NI \cdot \pi D_m$                    | ( from $F = B \times IL$ ) |
| $\mu_0$      | = | The permeability of air                                                      |                            |
| $H_w$        | = | Height of winding                                                            |                            |
| $D_m$        | = | Mean diameter of winding                                                     |                            |
| $I$          | = | Current Magnitude                                                            |                            |
| $N$          | = | The number of turn of winding                                                |                            |
| $a_c$        | = | The cross section area per turn of conductor                                 |                            |

#### a) In case of no cooling duct between turns (or layers)

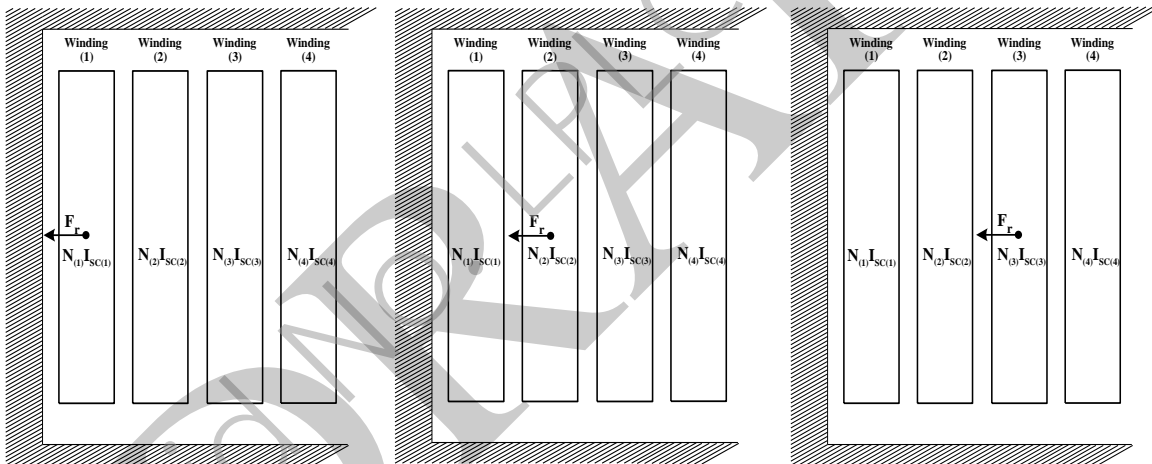

Apply with the density ( $\rho$ ) of copper = 8900 kg/m<sup>3</sup>

**For the winding (1) which is the innermost winding**

$$\sigma_{H(1)} = \frac{1}{8.9} \cdot \left( \frac{I_{sc(1)}}{a_{c(1)}} \right)^2 \cdot \frac{G_{w(1)}}{H_{w(1)}}$$

Where

- |                 |   |                                                                              |
|-----------------|---|------------------------------------------------------------------------------|
| $\sigma_{H(1)}$ | = | Hoop compressive stress in winding (1) .....kg/cm <sup>2</sup>               |
| $I_{sc(1)}$     | = | Short circuit through current in winding (1) .....A <sub>peak</sub>          |
| $a_{c(1)}$      | = | Cross section area per turn of conductor in winding (1) .....mm <sup>2</sup> |
| $G_{w(1)}$      | = | Gross weight of conductor in winding (1) .....kg                             |
| $H_{w(1)}$      | = | Height of winding (1) .....mm                                                |

**เอกสารไม่ควบคุม**  
 รับรองสำเนาโดย พทอ.ร. กสส.ร. อวส.  
 ก่อนนำไปใช้งาน  
 ต้องตรวจสอบ Revision ล่าสุด  
 ฝ่ายวิศวกรรมระบบส่ง กฟผ.

24 กุมภาพันธ์ 2569

**For the winding (2)**

$$\sigma_{H(2)} = \frac{1}{8.9} \cdot \left( \frac{I_{sc(2)}}{a_{c(2)}} \right)^2 \cdot \frac{G_{w(2)}}{H_{w(2)}} \cdot \left[ 1 \oplus \frac{2 \cdot N_{(1)} I_{sc(1)}}{N_{(2)} I_{sc(2)}} \right]$$

Where

- $\sigma_{H(2)}$  = Hoop compressive stress in winding (2) .....kg/cm<sup>2</sup>
- $I_{sc(1)}, I_{sc(2)}$  = Short circuit through current in winding (1), (2) .....A<sub>peak</sub>
- $a_{c(2)}$  = Cross section area per turn of conductor in winding (2) .....mm<sup>2</sup>
- $N_{(1)}, N_{(2)}$  = Number of turns in winding (1), (2) .....turns
- $G_{w(2)}$  = Gross weight of conductor in winding (2) .....kg
- $H_{w(2)}$  = Height of winding (2) .....mm

Consider the operator “ $\oplus$ ” as the direction of  $I_{sc(1)}$

The operator “ $\oplus$ ” = “-” if direction of the current is opposite to winding (2).

Or “ $\oplus$ ” = “+” if direction of the current is the same as winding (2).

**For the winding (3)**

$$\sigma_{H(3)} = \frac{1}{8.9} \cdot \left( \frac{I_{sc(3)}}{a_{c(3)}} \right)^2 \cdot \frac{G_{w(3)}}{H_{w(3)}} \cdot \left[ 1 \oplus \frac{2 \cdot N_{(1)} I_{sc(1)}}{N_{(3)} I_{sc(3)}} \oplus \frac{2 \cdot N_{(2)} I_{sc(2)}}{N_{(3)} I_{sc(3)}} \right]$$

Where

- $\sigma_{H(3)}$  = Hoop compressive stress in winding (3) .....kg/cm<sup>2</sup>
- $I_{sc(1)}, I_{sc(2)}, I_{sc(3)}$  = Short circuit through current in winding (1), (2), (3) .....A<sub>peak</sub>
- $a_{c(3)}$  = Cross section area per turn of conductor in winding (3) .....mm<sup>2</sup>
- $N_{(1)}, N_{(2)}, N_{(3)}$  = Number of turns in winding (1), (2), (3) .....turns
- $G_{w(3)}$  = Gross weight of conductor in winding (3) .....kg
- $H_{w(3)}$  = Height of winding (3) .....mm

Consider the operator “ $\oplus$ ” on each term as the direction of  $I_{sc(1)}$  and  $I_{sc(2)}$  individually.

The operator “ $\oplus$ ” = “-” if direction of the current is opposite to winding (3).

Or “ $\oplus$ ” = “+” if direction of the current is the same as winding (3).

**Note :** To determine hoop stress in tap winding, The gross weight ( $G_w$ ) and number of turn ( $N$ ) in the active conductor at different tap position shall be taken into account.

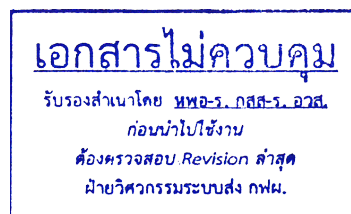

**b) In case of cooling duct being inserted between turns (or layers)**

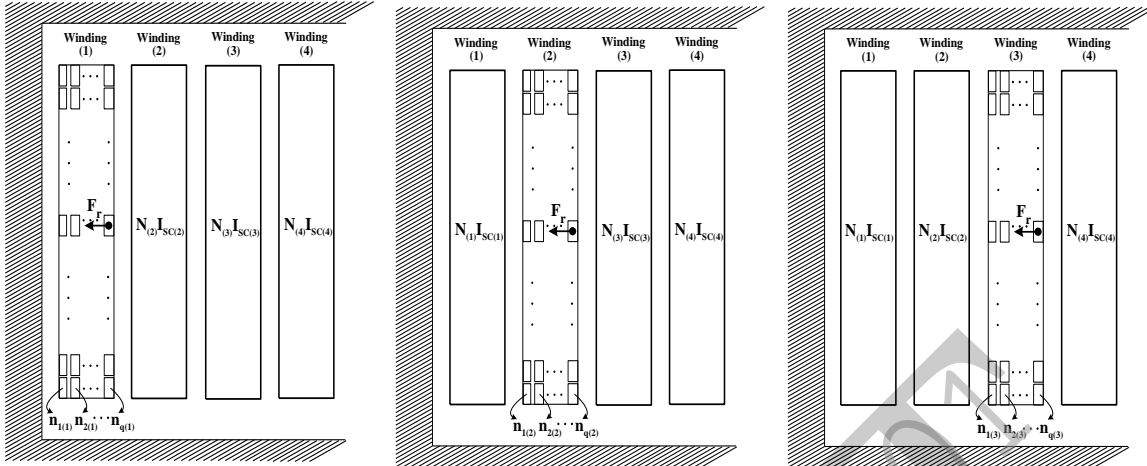

Apply with the density ( $\rho$ ) of copper = 8900 kg/m<sup>3</sup>

**For the winding (1) which is the innermost winding**

$$\sigma_{Hq(1)} = \frac{1}{8.9} \cdot \left( \frac{I_{sc(1)}}{a_{c(1)}} \right)^2 \cdot \frac{G_{w(1)}}{H_{w(1)}} \cdot \left[ \frac{2 \cdot \left( \sum_{i=1}^{q-1} n_{i(1)} \right) + n_{q(1)}}{\sum_{i=1}^q n_{i(1)}} \right] \cdot \left[ \frac{D_{mq(1)}}{D_{m(1)}} \right]$$

Where

- $\sigma_{Hq(1)}$  = The  $\sigma_H$  in outermost segment of winding (1) ..... kg/cm<sup>2</sup>
- $I_{sc(1)}$  = Short circuit through current in winding (1) ..... A<sub>peak</sub>
- $a_{c(1)}$  = Cross section area per turn of conductor in winding (1) ..... mm<sup>2</sup>
- $G_{w(1)}$  = Gross weight of conductor in winding (1) ..... kg
- $H_{w(1)}$  = Height of winding (1) ..... mm
- $n_{i(1)}$  = number of turn in the i<sup>th</sup> segment of winding (1) ..... turn  
(The sequence is started from core to outward)
- $q^{th}$  is the outermost segment
- $D_{mq(1)}$  = mean diameter of the outermost segment of winding (1) ..... mm
- $D_{m(1)}$  = mean diameter of winding (1) ..... mm

**For the winding (2)**

$$\sigma_{Hq(2)} = \frac{1}{8.9} \cdot \left( \frac{I_{sc(2)}}{a_{c(2)}} \right)^2 \cdot \frac{G_{w(2)}}{H_{w(2)}} \cdot \left[ \frac{2 \cdot \left( \sum_{i=1}^{q-1} n_{i(2)} \right) + n_{q(2)}}{\sum_{i=1}^q n_{i(2)}} \oplus \frac{2 \cdot N_{(1)} I_{sc(1)}}{N_{(2)} I_{sc(2)}} \right] \cdot \left[ \frac{D_{mq(2)}}{D_{m(2)}} \right]$$

เอกสารไม่ควบคุม  
รับรองสำเนาโดย หนอจ. กสส.ร. อวส.  
ก่อนนำไปใช้งาน  
ต้องตรวจสอบ Revision ล่าสุด  
ฝ่ายวิศวกรรมระบบส่ง กฟผ.

24 กุมภาพันธ์ 2569



Where

- $\sigma_{Hq(2)}$  = The  $\sigma_H$  in outermost segment of winding (2) ..... kg/cm<sup>2</sup>
- $I_{sc(1)}, I_{sc(2)}$  = Short circuit through current in winding (1), (2) ..... A<sub>peak</sub>
- $a_{c(2)}$  = Cross section area per turn of conductor in winding (2) ..... mm<sup>2</sup>
- $N_{(1)}, N_{(2)}$  = Number of turns in winding (1), (2) ..... turns
- $G_{w(2)}$  = Gross weight of conductor in winding (2) ..... kg
- $H_{w(2)}$  = Height of winding (2) ..... mm
- $n_{i(2)}$  = number of turn in the  $i^{th}$  segment of winding (2) ..... turn  
(The sequence is started from core to outward)

$q^{th}$  is the outmost segment

- $D_{mq(2)}$  = mean diameter of the outermost segment of winding (2) ..... mm
- $D_{m(2)}$  = mean diameter of winding (2) ..... mm

Consider the operator “ $\oplus$ ” as the direction of  $I_{sc(1)}$

The operator “ $\oplus$ ” = “-” if direction of the current is opposite to winding (2).

Or “ $\oplus$ ” = “+” if direction of the current is the same as winding (2).

**For the winding (3)**

$$\sigma_{Hq(3)} = \frac{1}{8.9} \cdot \left( \frac{I_{sc(3)}}{a_{c(3)}} \right)^2 \cdot \frac{G_{w(3)}}{H_{w(3)}} \cdot \left[ \frac{2 \cdot \left( \sum_{i=1}^{q-1} n_{i(3)} \right) + n_{q(3)}}{\sum_{i=1}^q n_{i(3)}} \oplus \frac{2 \cdot N_{(1)} I_{sc(1)}}{N_{(3)} I_{sc(3)}} \oplus \frac{2 \cdot N_{(2)} I_{sc(2)}}{N_{(3)} I_{sc(3)}} \right] \cdot \left[ \frac{D_{mq(3)}}{D_{m(3)}} \right]$$

Where

- $\sigma_{Hq(3)}$  = The  $\sigma_H$  in outermost segment of winding (3) ..... kg/cm<sup>2</sup>
- $I_{sc(1)}, I_{sc(2)}, I_{sc(3)}$  = Short circuit through current in winding (1), (2), (3) ..... A<sub>peak</sub>
- $a_{c(3)}$  = Cross section area per turn of conductor in winding (3) ..... mm<sup>2</sup>
- $N_{(1)}, N_{(2)}, N_{(3)}$  = Number of turns in winding (1), (2), (3) ..... turns
- $G_{w(3)}$  = Gross weight of conductor in winding (3) ..... kg
- $H_{w(3)}$  = Height of winding (3) ..... mm
- $n_{i(3)}$  = number of turn in the  $i^{th}$  segment of winding (3) ..... turn  
(The sequence is started from core to outward)

$q^{th}$  is the outmost segment

- $D_{mq(3)}$  = mean diameter of the outermost segment of winding (3) ..... mm
- $D_{m(3)}$  = mean diameter of winding (3) ..... mm

Consider the operator “ $\oplus$ ” on each term as the direction of  $I_{sc(1)}$  and  $I_{sc(2)}$  individually

The operator “ $\oplus$ ” = “-” if direction of the current is opposite to winding (3).

Or “ $\oplus$ ” = “+” if direction of the current is the same as winding (3).

**Note :** To determine hoop stress in tap winding, The gross weight ( $G_w$ ) and number of turn ( $N$ ) in the active conductor at different tap position shall be taken into account.

เอกสารไม่ควบคุม  
รับรองสำเนาโดย พหจ.ร. กสส.ร. อวส.  
.....mm ก่อนนำไปใช้งาน  
ต้องตรวจสอบ.Revision ล่าสุด  
.....mm  
สำนักงานวิศวกรรมระบบส่ง กฟผ.



## 2. Criteria for Hoop Compressive Stress

The calculated hoop compressive stress as above shall be satisfied the following criteria.

$\sigma_H$  and/or  $\sigma_{H,q} \leq 0.35 \cdot \sigma_{0.2}$  of copper for the normal copper conductor or CTC being used,  
or  $\leq 0.5 \cdot \sigma_{0.2}$  of copper for bonded CTC being used

## 3. Criteria for Hoop Tensile Stress

The hoop tensile stress can be calculated by the same method as hoop compressive stress in winding (1).

The calculated hoop tensile stress shall not exceed 80% of the  $\sigma_{0.2}$  of copper conductor being used.

In case of cooling duct being insert in between turn (or layer), the calculated hoop tensile stress of the innermost section should be applied.

**In case of cooling ducts being inserted between turns (or layers) affects the resulting stresses and position of the maximum hoop compressive and hoop tensile stresses, calculations for separate windings by the cooling ducts can be conducted using the formula from item a), which is for cases of no cooling duct.**

**เอกสารไม่ควบคุม**

รับรองสำเนาโดย ทพอ.ร.กสศ.ร. อวส.

ก่อนนำไปใช้งาน

ต้องตรวจสอบ .Revision ล่าสุด

ฝ่ายวิศวกรรมระบบส่ง กฟผ.

24 กุมภาพันธ์ 2569

**711-8 Temperature Rise.** Average winding temperature rise as measured by resistance method when carrying maximum continuous rated capacity at each of the stages of cooling shall not exceed 60°C. Hottest spot winding temperature rise when carrying maximum continuous rated capacity at each of the stages of cooling shall not exceed 75°C.

The temperature rise of the insulating oil shall not exceed 60°C when measured near the top of the main tank.

Average winding temperature shall be determined by the resistance method. During the heat run tests, the tank wall surface hot spot temperature rise shall not exceed 70°C.

The temperature rise test shall be made at the tap connections that produce the highest temperature rise, which in turn cause maximum losses in the windings, of both the de-energized tap changer and the on-load tap changer.

For three winding transformer, the simulating current for temperature rise test shall be calculated from any of the following load losses, which is a part of total loss, that give the highest simulating current.

- a) The combination of HV and LV load losses while HV and LV windings are delivering maximum output and TV winding is delivering no load.
- b) The combination of HV, LV and TV load losses while HV winding is delivering maximum output and the combination of the LV and TV windings are delivering maximum output (while TV winding is delivering maximum output of its own capacity).

**711-9 Audible Sound Levels.** The average sound pressure level (A weighted) of the transformers shall not exceed the value as specified in the Rating and Features sheet when measured in accordance with the conditions outlined in the latest IEC Std 60076-10.

**711-10 Linearity of Excitation Current (For 500 kV)** - The excitation curve of the transformer shall be linear up to 105% of rated voltage applied.

**711-11 Insulating Oil.** The property of the insulating oil shall be accordance with EGAT's SPECIFICATION OF MINERAL INSULATING OIL. The insulating oil furnished for filling at site shall be compatible with the oil remaining on the core and coils after factory testing of the power transformer and the amount furnished shall be sufficient for actual filling all power transformer. The contractor shall furnish EGAT at least 1% of oil quantity for field application as required. The oil shall be shipped in non-returnable steel drums which shall become the property of EGAT.

Specification of the insulating oil used shall be furnished with the power transformer. The certified test report shall also be submitted and attached to the transformer test report.

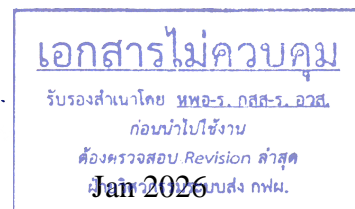

**711-12 Use of Inert Gas or Dry Air for Transportation.** Each core and coil unit shall be shipped in an atmosphere of inert gas or dry air to prevent moisture absorption. The core and coils shall be shipped as a unit in their tank. Transportation drawing including with detail of internal pressure of either tank or storage device shall be submitted for approval.

### **711-13 Control and Protection Schematic Diagram**

**711-13.1 AC-DC Circuit Arrangement.** EGAT shall provide 400/230 Vac, 50 Hz and 125 Vdc for auxiliary power supply. The Contractor shall furnish and install, where feasible, armoured cable or cable tray for all wiring as required. Short sections of flexible, waterproof conduit may be used for shock mounting. The Contractor shall arrange the schematic of AC and DC circuits as follows:

- a) Disconnecting means shall be provided for possible connection or disconnection of AC and DC circuits to or from EGAT's AC and DC supply.
- b) Circuit breakers of suitable interrupting rating but not less than 5 kA shall be provided for each branch of any AC or DC circuit. The LTC motor drive circuit breaker shall be operated by both thermal and magnetic trip. Contacts of all circuit breakers shall be operated by both manual and automatic trip.

Circuit breakers shall be furnished at least as follows:

- a) Common control cabinet (For Single phase transformer)
  1. Annunciator loss of DC supply indication AC supply circuit
  2. Annunciator DC supply circuit
  3. Auxiliary tripping and lockout relay DC supply circuit
  4. Transformer bank common AC main control circuit
  5. Transformer bank common AC branch control circuits as required
  6. Other transformer bank common DC branch control circuits as required.
- b) Each transformer control cabinet
  1. Group 1 AC cooling circuit
  2. Group 2 AC cooling circuit
  3. LTC drive motor AC circuit
  4. Annunciator loss of DC supply indication AC supply circuit
  5. Annunciator DC supply circuit
  6. Auxiliary tripping and lockout relay DC supply circuit (For Three phase transformer)
  7. Other AC branch control circuits as required
  8. Other DC branch control circuits as required.

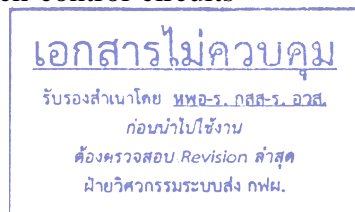

24 กุมภาพันธ์ 2569

- c) Three phase AC undervoltage relay and DC undervoltage relay shall be provided and located as shown on drawing of "AC-DC Circuit Arrangement" attached.

**711-13.2 LTC Control.** The LTC, if required, shall be provided with overcurrent protection in order to prevent the tap-change operation during a short circuit, which would too greatly stress the contacts of the diverter switch. Three instantaneous and self-reset overcurrent relays shall be equipped and the function of protection shall be arranged as follows:

- a. Whenever overcurrent is occurred, the control circuit for commanding LTC motor operation shall be blocked by the normally close contacts of the overcurrent relays. After overcurrent is cleared, the command control circuit shall be designed to recover immediately without any time delay.
- b. If during tap-change and overcurrent is occurred, the LTC motor circuit shall be blocked through the mechanical cam switch, which close from the very beginning to the very end of every tap-change operation, and the normally open contacts of the overcurrent relays. The stop motion of the motor shall be made through the motor brake contactor. The total operating time from energization of overcurrent relay until motor circuit is blocked shall not be more than 35 ms. After overcurrent is cleared, the motor circuit shall be designed to recover with the possible adjustable time delay of 0-60 s.
- c. For single phase transformer, three mounted, instantaneous, self-reset, phase overcurrent relays for diverter switch contact overstress protection and alarm indication on the common annunciator shall be provided in common control cabinet.

The schematic diagram for LTC overcurrent protection shall be as shown on typical drawing No TX-TSD-01 attached.

The LTC motor circuit shall be blocked when the tap change delay is occurred.

The control switches associated with the LTC equipment shall be of the rotary type and shall be designed for switchboard mounting with all contact mechanisms behind the panels. All contacts shall be enclosed in a cover or covers which can be easily removed. Each contact shall be of the readily renewable, self-cleaning type. Each control switch shall be insulated for 600 V, shall meet the requirements for dielectric tests and other applicable provisions of the latest version standards for power switching assemblies and shall have a continuous rating of at least 10 A. Each switch contact shall have an interrupting capacity on an inductive circuit of at least 2 A at 125 Vdc, and 20 A at 115 Vdc. A rectangular front of panel escutcheon plate shall be furnished and engraved showing the switch position of control switches. The switch identification shall be engraved on the escutcheon plate, or if necessary, on a separate adjacent nameplate furnished by the Contractor.

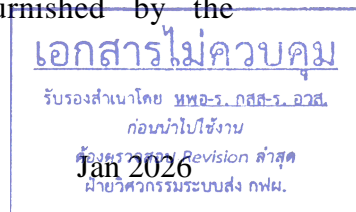

For Single Phase Transformer

Control equipment shall permit automatic and manual LTC control in the manner shown in the attached drawing. The equipment shall include the necessary devices for control and indication as follows:

- a) Local single phase manual control and tap position indication at transformer control cabinet.
- b) Local three phase automatic and manual control and phase tap position indication at transformer common control cabinet.
- c) Remote three phase automatic and manual control and phase tap position indication and tap changer operation indication at remote control board.
- d) Remote three phase automatic and manual control and phase tap position indication and tap changer operation indication at station control system.

When specified in the accompanying Ratings and Features Sheet, the LTC equipment shall include all necessary devices for master-follower scheme parallel operation with an existing transformer bank or another transformer bank furnished on the same purchase order. Drawings shall show by the use of solid lines all connections between transformer banks required for parallel operation. If parallel operation is not specified as being required, the LTC equipment shall include all necessary devices and provisions for future parallel operation, and dashed lines shall be used on the drawings to show all parallel operation connections required between transformers banks.

Alarm circuits for the following functions in addition to, but not limited to, those specified herein shall be furnished :

- a) Tap position discrepancy between phases
- b) Tap position discrepancy between transformer banks when operating in parallel (present or future)
- c) Tap change sequence incomplete within time recommended by the manufacturer.

The overcurrent protection equipment shall include the necessary relay and bushing current transformers.

The following LTC equipment accessories in addition to those specified herein shall be furnished:

- a) Mounted and wired in the common control cabinet (CCC)
  - 1. LOCAL-TEST-REMOTE selector switch (43LTR)
  - 2. 3PH-PHA-PHB-PHC selector switch (43BP)
  - 3. LOWER-RAISE manual control switch, spring return to intermediate neutral position (384CS)
  - 4. Three tap position receiver indicators. The tap position shall be indicated by .....IL, N, IR.....

เอกสารไม่ควบคุม  
ไม่ต้องส่งไปให้ กส.ร. อวส.  
ก่อนนำไปใช้งาน  
ต้องตรวจสอบ Revision ล่าสุด  
ฝ่ายวิศวกรรมระบบส่ง กฟผ.  
24 กุมภาพันธ์ 2569

5. LTC overcurrent relay of instantaneous and self-reset type with adjustable range around 150% of transformer rated current
  6. 43SP selector switch
- b) Mounted and wired in each transformer control cabinet (TCC)
1. Tap position receiver indicator. The tap position shall be indicated by ..... I L, N, IR.....
  2. LOWER-RAISE manual control switch, spring return to intermediate neutral position (184CS)
- c) Mounted and wired on each transformer LTC drive mechanism cabinet (DMC)
1. LOWER-RAISE test push buttons or control switch.
  2. 6-digit operation counter to register accumulated tap change operations
  3. 6-digit operation counter with reset knob to register accumulated tap change operations
  4. Mean for manual operation when power supply is lost
  5. Step by step operation control devices
  6. Tap position transmitting device for use with local and control board tap position receiver indicators
  7. Multi-tap resistance device for station control and national control center tap position indication via a transducer. Each tap position shall have an equal resistance value of at least 500 ohms. The device shall have a common control arm that rotates in relation to, but independent from, the tap changer by gear drive from the tap changer drive shaft. An alternate method for tap position indication transmission may be considered if it is complied to EGAT's requirement and shall be subject to EGAT's approval.
  8. Parallel operation checking device. Four (4) leads system shall be used for parallel operating checking.
  9. Phase tap position discrepancy checking devices.
  10. Mechanical tap position indicator. The tap position shall be indicated by...1L, N, 1R....
  11. Hand lamp with on-off switch.
  12. Space heater with thermostat and humidity control.
- d) Delivered the following devices for installation by EGAT on remote control board (RCB) for each three-phase transformer bank control and indication
1. Three receiver tap position indicators for semi- flush mounting, approximately 10x10 cm<sup>2</sup> dull black finish. The tap position shall be indicated by ...1 L, N, 1 R.....
  2. White indicating lamp for indicating the LTC during operation, the pilot lamp assemblies shall be of low power, cool operating, 24 Vdc, switchboard type and integrally mounted resistor for operation with 125 Vdc.

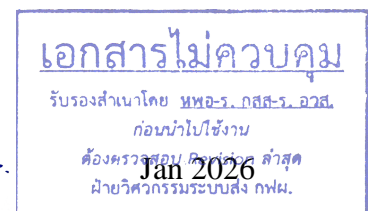
For Three Phase Transformer;

The LTC control circuit of the transformer shall be completely designed and provision shall be made for parallel operation as specified in the Ratings and Features sheet. The schematic diagram for future parallel operation part shall be shown by dotted line.

The mode for LTC control and switch positions on the escutcheon plate of selector switch and control switch shall be arranged as shown in relevant typical schematic diagram attached.

The following accessories and accessories for LTC control equipment shall be equipped for each transformer:

- a) The Contractor shall deliver the following devices for installation by EGAT.
  1. 43SP selector switch (installed at marshalling control cubicle).
  2. Tap position receiver indicator for the tap changer, which shall be a flush mounting type switchboard instrument approximately 10 cm square. The tap position shall be indicated by ... 1L, N, 1R (installed at remote control board).
  3. White indicating lamp for showing the LTC during operation. The pilot lamp assemblies shall be of low power, cool operating, 24 Vdc, switchboard type and integrally mounted resistor for operation with 125 Vdc (installed at remote control board).
- b) The Contractor shall furnish and mount the following control devices in the transformer control cabinet (TCC):
  1. 43LTR (LOCAL - TEST - REMOTE) selector switch
  2. 184CS (LOWER - RAISE) control switch of automatic or spring returned type to an intermediate "OFF" position for manual control of the motor-operated tap changer
  3. Tap position receiver indicator. The tap position shall be indicated by ..... 1L, N, 1R .....
  4. LTC overcurrent relay of instantaneous and self-reset type. (Having adjust range around 150% of transformer rated current.)
  5. Three phase undervoltage relay for AC supply
  6. Control and auxiliary relays
- c) The Contractor shall furnish and mount the following control devices on the LTC driving mechanism cabinet (DMC):
  1. " LOWER - RAISE " push buttons or control switch.
  2. Means for manual operation when power supply is lost.
  3. Tap change operation counter with two sets of 6 digits registering number, one set for registering the accumulated number of tap change performed and another set with resetting knob for possible recount of tap change performed.

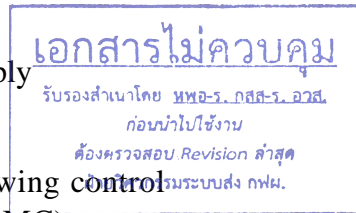

4. Step by step operation control devices
5. LTC parallel operation checking device provided for possible future installation of other identical LTC power transformer. Four (4) leads system shall be used for parallel operation checking. The schematic diagram for four (4) transformers parallel tap check shall be as shown on typical drawing attached.
6. Mechanical tap position indicator. The tap position shall be indicated by...1L, N, 1R ...
7. Device for transmitting the tap changer position to the tap position receiver indicators located at the transformer control cabinet and remote control board.
8. Multi-tap resistor device with number of taps equal to number of required tap positions for possible remote tap position indication by telemetering through the tap position transducer. Each tap position shall have an equal resistance value of at least 500 ohms. The multi-tap resistor device shall have common rotating arm which rotates in relevant with, but independently from the LTC tap changer, for example, by gearing from tap change driving shaft.  
Any alternative provision for possible remote tap position indication by telemetering may be considered if it is complied with EGAT's requirement and shall be subjected to EGAT's approval.
9. Hand lamp with on-off switch
10. Space heater with thermostat and humidity control

**711-13.3 Cooling Control.** Fans and/or oil pumps shall be automatically controlled by a transformer winding temperature relay and shall be furnished with all necessary control and protective device. The control circuit for each group of fans and/or pumps shall include a circuit breaker with thermal and magnetic trip, contacts with overload protection. The fan group shall be designed so that the control may be interchanged by a manual selector switch for winding temperature and starting relay control to facilitate maintenance and equalize wear between stages.

For Single Phase Transformer;

Control equipment for each group of fans shall include a circuit breaker with thermal and magnetic trip and an alarm contact, a magnetic contactor, START-STOP push buttons for manual control and other necessary devices. The magnetic contactor shall have two electrically separate convertible contacts, or the equivalent, adjusted one normally open, one normally closed for cooling fan operation remote indication. The contacts shall be wired to common control cabinet terminal block points via transformer control cabinet terminal block points.

The Contractor shall furnish the following devices in the common control cabinet for cooling equipment control.

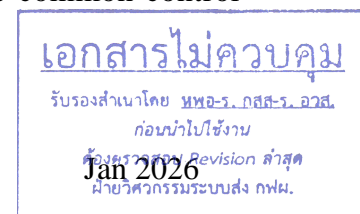
- a) IND-MAN-AUTO selector switch for phase manual, bank manual and automatic cooling fan control.
- b) FAN GRP.1 1<sup>st</sup> START-FAN GRP.2 1<sup>st</sup> START for fan group selection of first cooling stage
- c) START-STOP push buttons for bank manual control of each group of cooling fan.

The Contractor shall furnish the following devices in the transformer control cabinet for cooling equipment control.

- a) Automatic control of cooling equipment from winding temperature relay.
- b) "START-STOP" push buttons for manual control for each group of fans and oil pump motors.

Each group of cooling equipment shall operate from the same power source.

For Three Phase Transformer;

The Contractor shall furnish motor controls for the following requirements:

- a) Automatic control of cooling equipment from winding temperature relay.
- b) "START-STOP" push buttons for manual control for each group of fans and oil pump motors.
- c) MANUAL-AUTOMATIC selector switch for manual and automatic cooling fan control.
- d) FAN GRP.1 1<sup>st</sup> START-FAN GRP.2 1<sup>st</sup> START for fan group selection of first cooling stage.

The Contractor shall furnish all equipment mounted and wired on the transformer. In addition, the Contractor shall provide ON-OFF operation signal contacts for each group of fans and oil pump motors, wired to the control cabinet.

**711-13.4 Auxiliary Tripping and Lockout Relay.** The auxiliary tripping and lockout relay, high speed, with the total operating time, including bouncing time of each relay, when the trouble is occurred until the lock out relay is operated, shall not be more than 20 ms, manual reset shall be performed, 125 Vdc with 10 electrically separate normally close contacts and 20 electrically separate normally open contacts in only one lockout relay. The lockout relay shall be provided and located in transformer control cabinet (for three phase transformer) and in common control cabinet (for single phase transformer). These contacts shall be used for tripping and lockout open circuit breakers for transformer faults. The 86ACO "NORMAL-OFF" cut-off selector switch with 10 electrically separate contacts of 10 A continuous current rating shall also be provided and located in transformer control cabinet (for three phase transformer) and in common control cabinet (for single phase transformer).

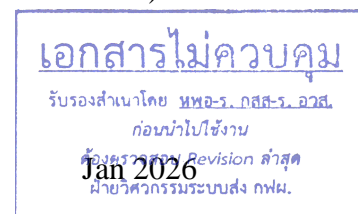

For any trouble which requires tripping order, the contact of the corresponding transformer protective relays shall be connection to

- a) Directly initiate the auxiliary tripping and lockout relay through the series auxiliary current operating relay with holding coil for annunciator.

Or

- b) Initiate high speed auxiliary voltage relay (operating time not more than 5 ms), self reset, DC voltage continuously operated type. Each high speed auxiliary voltage relay shall have at least 3 electrically separate normally open contacts, one contact for annunciator, one contact for Remote Terminal Unit (RTU), one contact for Fault Recording System (FRS) (only in case of single phase transformer) and one contact for initiation of auxiliary tripping and lockout relay. Each contact shall withstand at least 5 A, 125 Vdc at continuously duty.

The schematic diagram for tripping circuit shall be as shown on typical drawing No TX-TSD-04 attached.

**711-13.5 Annunciator.** A lamp type annunciator shall be furnished and installed within the control cabinet of the transformer. The annunciator shall indicate the transformer trouble described below.

Annunciator window shall be red in case of trip and winding temperature alarm stage 2, white in case of alarm. Transparent window shall be arranged in order that all individual trouble indicated on the annunciator panel can be visualized without opening the control cabinet cover.

Four (4) spare points of annunciator completed with annunciator circuit shall be provided in addition to the annunciators required. Each indication on nameplate shall be made of white translucent material, with black indicated letters. When any trouble contact is closed, the corresponding auxiliary relay of at least two independent contacts, one for signal lamp on annunciator panel and the other for remote indication, shall be energized and self-held which shall be reset, only if fault has already cleared, by the reset push button provided by the Contractor. Separate terminals shall be provided for each contact for remote indication. Each remote contact shall be wired to separate annunciator terminals. One remote indication contact shall be paralleled with other alarm points to provide a common remote alarm and one remote contact shall be provided for wiring to the substation sequence of events recorder.

The lamp test push button shall also be provided. Both reset and lamp test push button shall be mounted on the same panel of annunciator panel. If there are more than one fault occurs simultaneously, annunciators shall be annunciated correctly and only a fault that has cleared can be reset with the reset push button.

The schematic diagram for annunciator circuit shall be as shown on typical drawing No TX-TSD-03 attached.

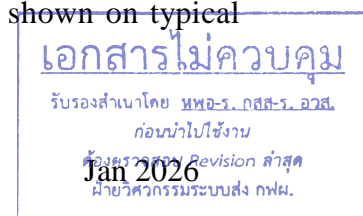

The tripping circuit part shall be independent from the annunciator circuit part in order that tripping is still possible while annunciator circuit is off. Diodes and integrated circuit components are not allowed for tripping and annunciating circuits.

The contacts of all relay, gauges, and thermometers shall be insulated from ground and shall be of a positive, snap action or mercury type. All alarm and trip contacts shall be suitable for operation on 125 Vdc.

The annunciator control voltage shall be 125 Vdc. The control voltage for LOSS OF DC SUPPLY indication shall be 230V, 50 Hz single-phase.

For Single Phase Transformer;

When a transformer or bank trouble condition occurs, the corresponding annunciator window shall be illuminated and two electrically separate contacts for remote indication shall close. The window shall remain illuminated and the remote indication contacts shall remain close until the reset push button is operated and the trouble is cleared. Each remote indication contact shall be wired to separate annunciator terminals.

One remote indication contacts of each transformer annunciator point shall be paralleled and wired to an associated common alarm point on the common control cabinet annunciator via terminal block points in the transformer control cabinet and in the common control cabinet. The other remote indication contacts, each shall be wired to separated terminal block points in the common control cabinet via terminal block points in the transformer control cabinet for connection by EGAT to the marshalling panel for RTU.

For remote indication contacts of the common control cabinet annunciator, each contact shall be wired to separated terminal block point in the common control cabinet for connection by EGAT to the marshalling panel for RTU.

For those trouble conditions requiring both circuit breaker tripping and annunciation, the trouble contact shall trip the circuit breaker via the transformer auxiliary tripping and lockout relay. Therefore, a high speed auxiliary relay with electric latch connected in series with the trouble contact shall be furnished. One contact of the latter relay shall be connected to actuate the annunciator. Two contacts of the latter relay shall be wired to common control cabinet separated terminal block points via transformer control cabinet terminal block points for connection to the marshalling panel for RTU and marshalling panel for FRS respectively. The high speed auxiliary relay shall be unlatched and reset, after the trouble is cleared, by operation of the annunciator reset push button. The annunciator and the transformer auxiliary tripping and lockout relay circuits shall be electrically separated.

Each annunciator equipment shall include a reset push button and a lamp test push button mounted on the annunciator or immediately adjacent to the annunciator.

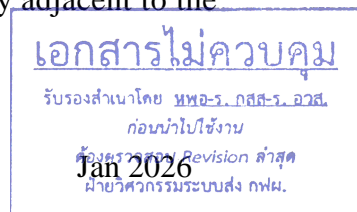

Annunciator panel, locate inside of the common control cabinet and transformer control cabinet, to indicate all Individual trouble of the transformer as listed in the “Common Transformer Annunciator Trouble & Tripping Schedule” and “Phase Transformer Annunciator Trouble & Tripping Schedule” attached.

For Three Phase Transformer;

When any trouble contact is closed, the corresponding auxiliary relay of at least two independent contacts, one for signal lamp on annunciator panel and the other for remote indication, shall be energized and self-held which shall be reset, only if fault has already cleared, by the reset push button provided by the Contractor. Separated terminals shall be provided for each contact for remote indication.

Annunciator panel, locate inside of the control cabinet, to indicate all Individual trouble of the transformer as listed in the “Transformer Control Cabinet Annunciator Trouble & Tripping Schedule (For Three phase transformer)” attached shall be provided.

**711-13.6 Winding temperature relay**

For Single Phase Transformer;

A total of three ambient temperature compensated winding temperature relays (one per winding) each with four sets of fully independent and adjustable switches with ungrounded contacts, factory adjusted close at temperatures no higher than the following values.

- Contact set No.1-95°C to initiate 1<sup>st</sup> stage cooling
- Contact set No.2-105°C to initiate 2<sup>nd</sup> stage cooling
- Contact set No.3- 115°C for alarm stage 1
- Contact set No.4-120°C for alarm stage 2

On decreasing temperature, contact sets No. 3 and No. 4 shall open at not more than 5°C below the closing temperature values. Similar contact sets of all relays shall be connected in parallel.

Each relay shall be responsive to the temperature of the hottest oil near the top of the transformer plus winding rise above hot oil temperature. The winding hot spot rise response shall be provided by a heating coil connected to the secondary of a current transformer located to sense winding current. The bellows heater system, rather than the pocket system (heating coil in relay thermometer bulb well), of establishing winding temperature is preferred.

Leads and means for calibration of each relay shall be provided and terminated in a weatherproof housing located on the transformer tank in a location convenient for inspection or testing.

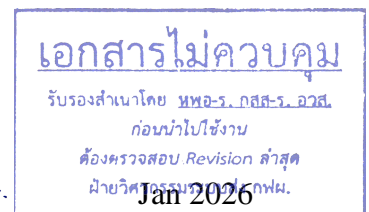

All devices and accessories, including current transformers, required for operation of the relays shall be furnished.

The Contractor shall furnish all wiring and armoured cable or cable tray from the winding temperature relay equipment to the transformer control cabinet.

For Three Phase Transformer;

Any transformer with capacity smaller than 50 MVA shall be provided with one set of winding temperature relay, while another with capacity of 50 MVA or larger, provision of two sets of winding temperature relay, one for high voltage or series winding, the other for low voltage or common winding. Contacts for the two relays shall be connected in parallel.

Each set of winding temperature relay comprising of only one relay with ambient temperature compensation and four electrically separate sequence switches or at the Contractor's option, comprising of two relays with two or three switches each, may be furnished. The "make" and "break" temperatures of each switch shall be fully and independently adjusted. The first and second sequence switches will be used for controlling the cooling equipment. The third sequence switch will be used for alarm stage 1, and the fourth sequence switch will be used for alarm stage 2. The third and fourth sequence switches shall be suitable for operation on 125 Vdc. The heater of the winding temperature relay shall be connected to the secondary of a current transformer which has as its primary the lead to the power transformer winding. The bellow heater system, rather than the pocket system (heating coil in relay thermometer bulb well), of establishing winding temperature shall be furnished. The temperature sensing device shall be located in the oil near the top of the transformer.

The relay or relays shall be designed to be responsive to the current in the windings and to top oil temperature and shall be calibrated to operate on the duration and magnitude of the temperatures of the transformer winding and oil. The relays shall be factory adjusted to close at temperatures no higher than the following values.

- Contact set No.1-95°C to initiate 1<sup>st</sup> stage cooling
- Contact set No.2-105°C to initiate 2<sup>nd</sup> stage cooling
- Contact set No.3- 115°C for alarm stage 1
- Contact set No.4-120°C for alarm stage 2

With temperature decreasing the third and fourth sequence switches shall open contacts within 5°C below the closing values.

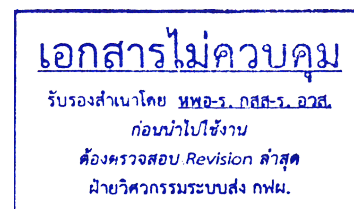

**711-14 Accessories.** Each transformer shall be furnished complete with, but not limited to, the following accessories in addition to those otherwise specified in this specification:

**711-14.1 Oil Level Indicator.** A dial type liquid level gauge with high and low-level alarm contact shall be furnished to monitor the transformer conservator oil level. The gauge shall be located for ease in reading from ground level. An output switch with output contacts shall be provided for annunciation. The relay shall include normally open contacts which shall be factory set to close when the oil level drops to an undesirable level. Dial range shall be matched with oil temp - oil level curve.

**711-14.2 Oil Temperature Indicator.** A dial type thermometer with the dial range of 0-150°C, display window shall be glass and alarm contact to close on high oil temperature shall be furnished to monitor the transformer oil temperature. The gauge shall be located for ease in reading from ground level at the transformer tank. Degree of Protection shall be IP65. 4-20 mA shall be provided for online monitoring system and the signal of Platinum resistance type 100 ohms (PT-100) at 0°C shall be provided for remote indication.

**711-14.3 Winding Temperature Relay.** A dial type meter with the range of 0-160°C shall be furnished for winding temperature indication at the transformer tank. The display window shall be glass. The gauge shall be located for ease in reading from ground level at the transformer tank. Two separately adjustable output switches shall be furnished, one for annunciation and the other for energizing a lockout relay. Degree of Protection shall be IP65. 4-20 mA signal shall be provided.

**711-14.4 Winding hot-spot temperature detector.** A winding hot-spot temperature detector of the Platinum resistance type 100 ohms (PT-100) at 0°C in high voltage winding and low voltage winding, shall be furnished together with necessary accessories, arranged for remote indication for use with a temperature recorder which will be provided and mounted on a switchboard by the others. The heater for the detector shall be connected to the secondary of a current transformer winding, and shall be located in the oil near the top of the transformer.

**711-14.5 Pressure relief device.** A self-reset type pressure relief device shall be provided to prevent excessive pressures from building up inside the tank which could cause equipment damage. The pressure relief device shall automatically reset following an operation and shall be furnished with a semaphore or other visible indicator of an operation of the device, visible from ground level. It shall have trip contacts to provide indication of an operation of the device. Degree of Protection shall be IP65.

**711-14.6 Buchholz relay.** A Buchholz relay shall be furnished which will provide fault pressure and gas detecting features. The Buchholz relay shall be furnished with two contact outputs, one for alarm and the other for trip which shall be free from operation due to vibration and pump surges. The relay shall be mounted in the connecting pipe between the main tank and the conservator and shall be complete with gas accumulation alarm feature. Valves with flange shall be provided for both sides of relay.

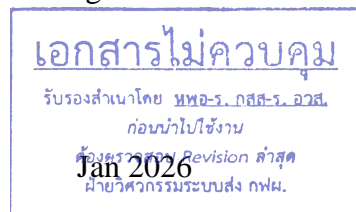

**711-14.7 Sudden pressure relay.** Sudden pressure relay with alarm contact mounted on the transformer tank below minimum oil level, for transformer with the capacity of 100 MVA or larger. Degree of Protection shall be IP65.

**711-14.8 Air detector relay.** Air detector relay to alarm the annunciator in the event that air enters the conservator as a result of rupture of the rubber bag.

**711-14.9 Valves.** Valves with flange connection completed with blank cover plate of at least for the followings:

- Two units for combination of oil drain valve and lower oil filter-press connection for main tank.
- A combination of oil filling valve, vacuum valve and upper oil filter-press connection for main tank
- Oil drain valve for main conservator
- A combination of oil filling valve, vacuum valve and upper oil filter-press connection for main conservator
- Connecting valve for main conservator to main tank (Excluding blank cover plate)
- Connecting valve between air part and oil part of main conservator for evacuation
- The drain and filter valves shall be extended down and located for ease in operating from ground level.

**711-14.10 Oil sampling device.**

**711-14.11 Diagrammatic nameplate,** including indication of EGAT's Contract No, Item No and EGAT's Serial No. The indication of impedance voltage shall also be included max. and min. tap voltage of on load tap changer and de-energized tap changer (if any).

**711-14.12 Oil temp-oil level curve plate.**

**711-14.13 Separate Stainless Steel Ground Terminal Connectors** of clamp type located at transformer base provided for the followings:

- HV surge arresters (if any)
- LV surge arresters
- TV surge arresters (if any)
- Neutral bushing
- Tertiary bushing for grounding purpose (if any)
- Transformer tank
- Transformer control cabinet

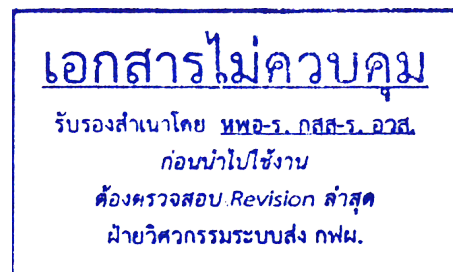

24 กุมภาพันธ์ 2569

The ground terminal connectors shall be suitable for No 4/0 AWG copper cable. All the ground leads shall be of No 4/0 AWG insulated ground wire fixed by porcelain insulators on the transformer tank. All ground leads shall be

provided and connected from the above mentioned equipment to ground terminal connectors.

**711-14.14 Cover, Handholes and Manholes.** A welded main cover, handholes and manholes for servicing shall be provided with following minimum dimension:

Handholes : 22.9 cm in diameter,  
or 11.4 cm x 36.8 cm if rectangular

Manholes : 38.1 cm in diameter,  
or 25.4 cm x 40.6 cm if rectangular

**711-14.15 Pressure gauge for transportation.**

**711-14.16 Three-dimensional shock recorder** with time period recording chart of at least 3 months for transportation on the basis of returning back after the transformer arrive at the substation site.

**711-14.17 Silica-gel breather for main conservator.**

**711-14.18 Ladder.** Ladder fixed on transformer tank and extended to top part of conservator for servicing the transformer. The caution plate to prevent an unauthorized person shall be provided.

**711-14.19 Suitable jacking pads, pulling eyes and lifting lugs.**

**711-14.20 Lighting and outlet.**

**711-14.21 Gas sampling valve.** A gas sampling valve shall be furnished and located such that gas sampling for the detection of gas formation can be obtained safely while the transformer is energized.

**711-15 Bushing Current Transformer.** All bushing current transformers shall be in accordance with the latest IEC Std 61869 and shall have subtractive polarity. The bushing current transformers shall be in addition to those which may be required for operation of the temperature relays and load tap changing equipment. The secondary leads from all bushing current transformers shall be brought to short-circuiting-type terminal blocks located in the transformer control cabinet. A separate 6 point terminal block shall be provided for each current transformer secondary winding. The terminal blocks shall be of short circuiting, molded type with insulating barriers, ring tongue crimp type terminals and marker strips, and shall be rated 600 V. Each terminal block shall be capable of accommodating two 6 mm<sup>2</sup> stranded conductors minimum for secondary current 5 A and two 4 mm<sup>2</sup> stranded conductors minimum for secondary current 1 A. Terminal blocks shall be arranged in a vertical row or rows. In case of slide-type terminal blocks are provided, fixed side shall be from secondary leads of bushing current transformers and slide side shall be for external connections to control room.

A minimum clear space of 125 mm shall be provided between terminal blocks and between terminal blocks and the cabinet sides for training connections to the terminal blocks. All terminal block connections shall be made using ring tongue, crimp type terminals. Each terminal block current transformer tap connection shall be marked to identify the associated tap. All current transformer secondary

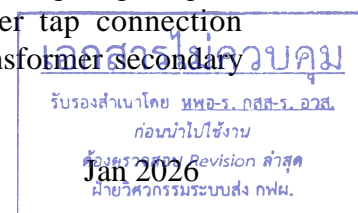

winding connections shall be 6 mm<sup>2</sup> minimum for secondary current 5 A and 4 mm<sup>2</sup> minimum for secondary current 1 A.

For Single Phase Transformer; All taps of each bushing current transformer shall be wired to the short circuiting terminal block in the transformer control cabinet and two wires from each CT short circuiting terminal block to the common control cabinet. Current transformers in the same core location on each transformer shall be three phase grouped (A-B-C) top to bottom. The Contractor shall furnish all necessary wiring conduit, cable tray and accessories for making the required current transformer to control cabinet and control cabinet to common control cabinet interconnections.

- 711-16 Surge Arrester.** All surge arresters to be furnished shall meet all applicable requirements of the Specification of Metal Oxide Surge Arrester attached. When possible, the height of the arrester terminals shall match approximately the height of associated bushing terminals. Discharge counters with continuous AC leakage/internal current indicators shall be mounted approximately 1.5 m above ground level. Surge arrester to discharge counter to ground pad connections in accordance with the requirements stated herein shall be installed.
- 711-17 Device Contacts.** All relay, gauge, thermometer and other device alarm and trip contacts shall be ungrounded, shall be positive, snap-action or mercury type and shall be rated at 125 Vdc. If necessary, interposing auxiliary relays may be furnished to satisfy these requirements.
- 711-18 Gaskets.** Gaskets shall be unaffected by hot insulating oil, retain their resiliency during the life of the associated equipment, and be unaffected by weather while maintaining oil and gas tightness. Nitrile gaskets shall be used except where the gaskets may be affected by heat, such as during welding. In such case, cork-neoprene or cork-Nitrile gaskets shall be provided. Gaskets of cork or neoprene only will not be allowed. Gasket flanges shall have grooves or stops to prevent gasket over compression.
- 711-19 External Clearances.** The transformer and all equipment attached to it shall have the external clearances between live parts specified in IEC Std 60076-3.
- 711-20 Wind Load.** Each completely assembled transformer shall be designed to withstand wind with a velocity up to 125 km/h without damage to or impairment of operation of the transformer or any part thereof.
- 711-21 Cleaning & Painting.** All interior and exterior surfaces of ferrous metalwork (including the sound enclosure, if required) shall be either galvanized in accordance with ASTM Designation A123 and A153 or painted. Surfaces to be painted shall be thoroughly cleaned to base metal by sand blasting or shot blasting and shall be thoroughly dry before application of any paint. After cleaning, the surfaces shall be given a priming or sealing coat of paint followed by two finishing coats. The paint used for the exterior finish coats shall have special heat, oil, and weather-resisting properties. The exterior surfaces of the transformer control cabinet and any other parts which expose to the outside looking (including the sound enclosure, if required) shall be painted in ANSI 70 light grey or MUNSELL NOTATION NO 7.5 BG 6/1.5. The total exterior paint thickness shall be a minimum of 105.

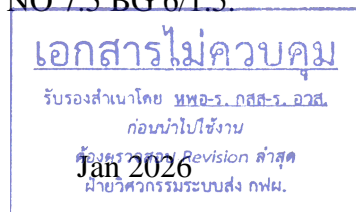

**711-22 Markings & Nameplates.** Each transformer shall be provided with an attached identification nameplate or nameplates satisfying, but not limited to, the requirements of IEC Std 60076. The nameplate(s) shall include the EGAT contract number, item number and EGAT's serial number and be located to be readily legible from ground level. The nameplate and/or an adjacent nameplate shall include for each current transformer the accuracy class and primary and all secondary ampere ratings and identification of the terminal to which each applies. A connection diagram of all windings, current transformer and associated devices shall be included in the nameplate. The nameplates shall be black letters engraved on a background.

Individual nameplates shall also be furnished with each valve, oil sampling device, level device, temperature device, Buchholz relay and all control cabinet devices which identify the device and pertinent characteristics.

Each transformer control, indicating and protective component, not otherwise clearly identified, shall be provided. All nameplate identification engraving shall be in English. Nameplate engraving shall be subject to EGAT approval.

All nameplates shall be anodized aluminum, stainless steel or other corrosion-resistant material and shall be attached with non-corroding screws.

**711-23 Test.** Test for power transformer, on load tap changer, de-energized tap changer, bushing and bushing current transformer shall be performed according to the requirement specified in each referred test item. The costs of all tests and reports shall be borne by the Contractor.

**711-23.1 Type Test.** The transformers shall be subject to the actual type tests, unless otherwise specify in each test item.

**711-23.2 Routine Test.** Each equipment shall be completely assembled at the factory and subject to the tests specified in each equipment test item.

**711-23.3 Special Test.** The test report shall be submitted together with tender document during the bidding if specified in Eligibility of Bidders.

**711-23.4 Test Report.** The report of all tests, curves and standard application data shall be furnished to EGAT immediately after completion of the tests.

**711-23.5 Test Procedure.** The Contractor shall submit the test procedure of routine tests and actual type tests to EGAT for approval. The test procedure shall consist of procedures, applied voltage, current and criteria to justify the result of the tests.

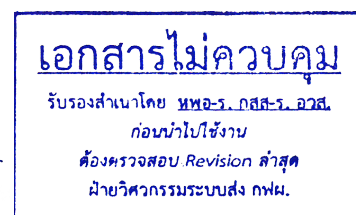

24 กุมภาพันธ์ 2569

## 711-23.6 Test Items for Type Test.

- a. **Transformer.** The tests shall be performed in accordance with the latest IEC Std 60076. One unit of transformer being supplied for each capacity and voltage rating shall be subject to the following test.

1. Temperature-rise type test

The test shall be performed on each winding for each cooling stage. DGA result shall be shown before and after temperature rise test. The test report shall be shown the calculated values of the hottest spot winding temperature rise over top oil for each cooling stage.

These calculation values shall include the effects of local loss generation and local cooling conditions which could affect the winding temperature rise. A standard allowance for extra temperature rise beyond that of the average winding temperature shall not be acceptable.

2. Switching impulse test.

The transformer for 115 kV shall be performed the switching impulse test, which shall precede the low frequency tests. Oscillographic records of voltage and current with time scale of the tests performed shall be submitted.

3. Determination of sound level for each method of cooling for which a guaranteed sound level is specified (including no-load and load condition).

4. Vacuum deflection test on liquid immersed transformers.

The transformer tank shall be subject to a vacuum of less than 10 mmHg for 30 min. After the test, the deformation shall be checked.

5. Pressure deflection test on liquid immersed transformers.

The transformer tank shall be subject to an internal gas pressure of 1 kg/cm<sup>2</sup> for 30 min (or equivalent pressure giving 1 kg/cm<sup>2</sup> at every tank surface) and under the pressure test the leakage shall be checked.

6. Jacking pad capability test.

The test shall be performed on complete assembled transformer with oil for 30 min.

- b. **On Load Tap Changer.** The tests shall be performed in accordance with the latest IEC Std 60214. On load tap changer shall already have the type test record for same type or same family and similar ratings as proposed. The type test record shall be required and submitted together with tender document during the bidding.

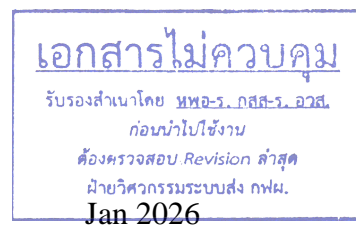

- c. **De-energized Tap Changer.** The tests shall be performed in accordance with the latest IEC Std 60214. De-energized tap changer shall already have the type test record for same type or same family and similar ratings as proposed. The type test record shall be required and submitted together with tender document during the bidding.
- d. **Bushing.** The tests shall be performed in accordance with the latest IEC Std 60137. The tests shall be performed on one bushing of an identical unit. These tests may be omitted if a type test record of an identical unit can be submitted.

#### 711-23.7 Test Items for Routine Test.

- a. **Transformer.** The tests shall be performed in accordance with the latest IEC Std 60076. The following tests shall be performed.

1. Measurement of winding resistance
2. Measurement of voltage ratio and check of phase displacement
3. Measurement of short-circuit impedance and load loss

The measurement shall be performed for all winding of each cooling stage by using the three wattmeters (for three phase transformer) method conformed to the following:

- Maximum rated capacity at all tap connection.
- Other stage of cooling at rated and extreme tap connections.

The measurement shall be performed at rated tap current of each capacity, reduced current are not allow.

4. Measurement of no-load loss and current

The measurement shall be carried out by using the three wattmeters (for three phase transformer) and the average-voltage voltmeter method from 10% up to 100% rated voltage with 10% interval, 105% and 110% rated voltage. (To be performed before and after the impulse test). Excitation curve shall be submitted.

5. Dielectric routine tests

The tests shall include chopped wave lightning impulse test, full wave lightning impulse test and switching impulse test (for 230 kV and above) for every winding and neutral terminal.

Impulses shall be applied in the sequence high voltage winding, low voltage winding, tertiary winding, neutral terminal. Oscillographic records with voltage, current and time scale of the tests performed shall be submitted.

After all of Impulse tests, the operating test for On Load Tap Changer, if required, shall be performed. Transformer shall be energized at rated voltage and rated frequency at no-load condition, one complete cycle of operation shall be performed without failure.

6. Tests on on-load tap-changers, where appropriate.

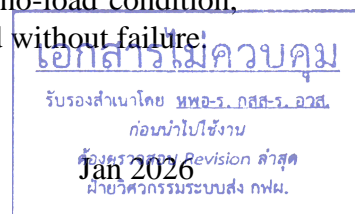

7. Leak testing with pressure for liquid-immersed transformers (tightness test).

The assembled transformer shall be subject to a pressure of 1 kg/cm<sup>2</sup> at the bottom of the tank for 12 h and then the leakage shall be checked.

8. Check of the ratio and polarity of built-in current transformers.
9. Check of core and frame insulation for liquid immersed transformers with core or frame insulation
  - Insulation between core and clamp.
  - Insulation between core and ground.
  - Insulation between clamp and ground.
10. Determination of capacitances windings-to-earth and between windings.
11. Measurement of d.c. insulation resistance between each winding to earth and between windings.
12. Measurement of dissipation factor ( $\tan \delta$ ) of the insulation system capacitances.
13. Measurement of dissolved gasses in dielectric liquid from each separate oil compartment except diverter switch compartment before and after completion of the test.
14. Cooling fan loss measurement.
15. Measurement of zero-sequence impedance(s) on three-phase transformers.
16. Measurement of frequency response (Frequency Response Analysis or FRA).

The test shall be performed on complete assembled transformer. Test tap positions to be selected shall include maximum, rated, minimum tap of on load tap changer and the tap position giving only the main winding (without or the least tap winding). For transformer provided with de-energized tap changer, the full winding tap of the de-energized tap changer shall be selected.

The measuring frequency range shall be from 20 Hz to 2 MHz. The result shall be plotted by “Amplitude or Magnitude (dB) vs frequency and Phase angle vs frequency in log scale”.

Software file and XML file of FRA data shall be provided by contractor.

17. Dynamic resistance measurement (If LTC is required).

The test shall be performed by the application of DC current or DC voltage to the winding with tap changer while the other winding short-circuited. The transient test current fluctuations shall be recorded during the tap changer switching process. The response shall be recorded with an oscilloscope, transient recorder or a specialized instrument. The oscillograms of maximum to minimum

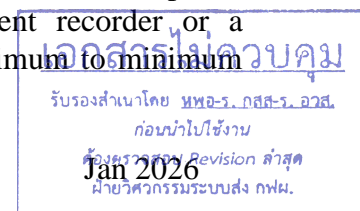

tap and minimum to maximum tap with each tap transition shall be reported.

For the winding with tap changer connected in star connection. Simultaneous three phase test shall be performed and the test current flowed through each phase shall be 1 A or more while the other winding short-circuited.

For the winding with tap changer connected in delta connection. Single phase test shall be performed and the test current flowed through phase under test shall be 1 A or more. For this case the applied current shall be 1.5 A or more.

18. Single phase leakage impedance measurement (for reference).

The test shall be performed by the application of the low-voltage single-phase voltage with rated frequency to each pair of phase terminal of one winding while the other winding on the same core leg short-circuited (using a low impedance conductor). The energized winding shall be the winding with higher voltage and the short-circuited winding shall be the winding with lower voltage. Each pair of windings shall be tested. The current shall be kept constant for each pair of tested winding at the full value such as 2, 3 or 5A. The test voltage shall be as close as 400 V.

For items (1.), (2.), (3.) and (18.) the test shall be performed at all tap connections of on load tap changer for all windings. If there is de-energized tap changer, additional measurement shall be performed at max., rated and min. tap of on load tap changer for all tap connections of de-energized tap changer.

- b. **On Load Tap Changer.** The tests shall be performed in accordance with the latest IEC Std 60214.
- c. **De-energized Tap Changer.** The tests shall be performed in accordance with the latest IEC Std 60214.
- d. **Bushing.** The tests shall be performed in accordance with the latest IEC Std 60137.
- e. **Bushing Current Transformer.** The tests shall be performed in accordance with IEC Std 61869-1 & 61869-2.
- f. **Material Tests Report.** Test report of the following material and accessories used in each supply shall be submitted

- 1. Insulating oil.
- 2. Silicon steel.
- 3. Copper conductor.
- 4. Insulation paper and pressboard.
- 5. Radiator.
- 6. Transformer supervisory equipment.

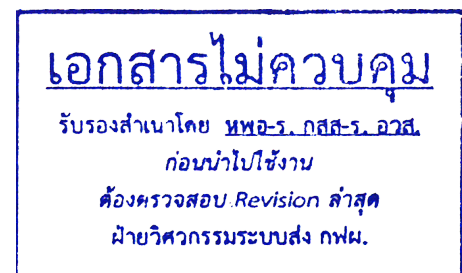

24 กุมภาพันธ์ 2569

- (a) Oil level indicator
- (b) Oil temperature indicator
- (c) Winding temperature relay / Winding hot spot detector
- (d) Buchholz relay
- (e) Pressure relief device
- (f) Rubber bag rupture detector

**g. Information for Reference.** The following information for each transformer shall be submitted and attached in routine test report for maintenance purpose.

- Coil height for each winding before assembly and after complete assembly.
- Torque value on clamping bolts or pressure for each winding before assembly and after complete assembly.
- Photograph of each coil for each phase and photograph of core and coils assembly. The photograph of each coil shall be taken from the final production process before placing to the core, top view and front view shall be provided. The photograph of core and coils assembly shall be taken just prior to place the completed core and coils assembly into the tank, top view, front view, right view, left view and rear view shall be provided for complete set of photographs

#### 711-23.8 Test Items for Special Test.

##### 1. Short circuit test.

The short circuit test record, in accordance with the following item 3. below, of the transformer similar design, which is subject to EGAT's approval, is required and shall be submitted together with tender document during the bidding.

For transformer having the capacity of 50 MVA or less, the short circuit test record of the actual transformer instead of model unit of the transformer is required.

If actual short circuit test is specified to be performed, the transformer required for short circuit tests shall be subject to the sequence of tests listed below in accordance with the latest IEC Std 60076-5 or IEEE Std C57.12.90.

1. Internal inspection before tanking including measurement of coil height and torque value or pressure on clamping bolts for winding clamping.
2. Routine tests according to the requirement of this specification before short circuit test.
3. Short circuit test having the number and duration of tests conformed to IEC Std 60076-5 or IEEE Std C57.12.90.
4. Detection of faults and evaluation of test results shall be conformed to IEC Std 60076-5 or IEEE Std C57.12.90.

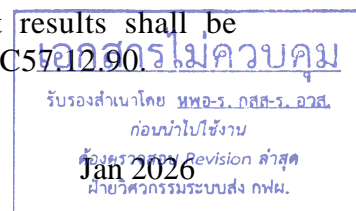
5. The transformer is untanked for internal inspection including measurement of coil height and torque value or pressure on clamping bolts for winding clamping.
6. The transformer shall be retanked and the routine tests according to the requirement of this specification shall be performed after the short circuit test.

**711-24 Spare Parts.** Spare parts as specified in Price Schedule and one complete set of spare gasket for each transformer to be used during erection at site shall be supplied. All spare parts including spare gasket subject to damage or deterioration by moisture shall be packed in moisture-proof material. All spare parts shall be of the same materials and workmanship as the corresponding original parts and shall be interchangeable therewith.

**711-25 Appliances and Tools.** The Contractor shall furnish all special appliances and tools that the equipment manufacturer deems necessary for satisfactory installation, operation, testing and maintenance of the equipment, including assembly and disassembly. Special tools and appliances shall be constructed as those that are not readily available from appliance and tool suppliers in Thailand and those that the equipment manufacturer has procured or fabricated for use with the equipment or similar equipment. The Contractor shall submit to EGAT for approval a list of all appliances and tools required for above stated purposes and shall indicate thereon all furnished appliances and tools.

**711-26 Final Design Data.** The Contractor shall furnish the following final design data for each transformer based on final design calculations :

- a) Losses in kilowatts at rated voltage and frequency:
  1. No load loss
  2. Load losses at maximum rated capacity
- b) Percent regulation:
  1. At unity power factor
  2. At 0.90 power factor lagging
  3. At 0.80 power factor lagging
- c) Excitation curve from 10% to 110% normal rated voltage. The following exciting current shall be clearly specified.
  1. At 110% of normal rated voltage
  2. At 105% of normal rated voltage
  3. At normal rated voltage
  4. At 95% of normal rated voltage
  5. At 90% of normal rated voltage
  6. At 80% of normal rated voltage
- d) Temperature rise of all windings and top oil at each cooling capacity. Hot-spot factor and formula of this value shall be provided for calculation of Hottest spot winding temperature rise.

**เอกสารไม่ควบคุม**  
รับรองสำเนาโดย ทพอ-ร. กสส-ร. อวส.  
ก่อนนำไปใช้งาน  
ต้องตรวจสอบ.Revision ล่าสุด  
ฝ่ายวิศวกรรมระบบส่ง กฟผ.

24 กุมภาพันธ์ 2569

- e) Overall dimensions and weight of all principal parts.
- f) Identification by name and total weight and dimensions of heaviest part that must be lifted by the crane during assembly and disassembly.
- g) Percent positive, negative and zero phase sequence impedance based on maximum rated capacity at max., rated and min. tap voltage of on load tap changer and de-energized tap changer for all winding.
- h) Detailed calculation showing all parameters of electro-mechanical stress and force results shall be submitted to demonstrate that the transformer as designed can withstand the effects of through faults both in magnitude and frequency. These data shall be compared to critical failure stress for each major failure mode such as inward radial hoop buckling, outward radial hoop stretching, conductor tilting, stress on spacer and coil end support force capability. The results shall include the magnetic leakage field plot.
- i) Data and information requirement as shown on "Winding Arrangement Data" and "Coil Conductor Data for Each Winding" attached sheets.
- j) Permissible limit of partial discharge value.
- k) The setting temperature value for the first and the second stage of cooling fan including calculation method.

In case of the sound enclosure is required, all of final design data shall be calculated and considered the transformer completed with the sound enclosure.

Increases in values of items (e) and (f) over those given in the Proposal Data shall be limited to 10% but not more than EGAT's specified values elsewhere.

Increases in values of Electro-Mechanical Stress/Force under short circuit condition or increases the relative stresses over those given in the Proposal Data shall be not acceptable.

**EGAT reserves the right to review the detailed design of transformer without changing the guaranteed losses values.**

**711-27 Transportation.** The transformer shall be designed to suit the trailer for transportation as shown on the Dwg. No EGAT-24A/L (1+1/2)-TH62 attached as well as the dimension and weight limitation specified elsewhere. The transformer shall be designed for transporting with the maximum trailer speed on highway at 45km/h. The permissible impact value of transformer during transportation shall be designed not less than  $\pm 3G$  in three dimensions (x, y, z axis). Shipping weight and dimensions of every transformer shall be measured and reported before transportation.

**711-28 Drawings and Documents for Power Transformer.** Drawings and documents for approval shall at least comprise of the following;

Final Design Data is the first document required to submit for approval after confirmation of Letter of Award of Contract.

**A. Drawings for Approval**

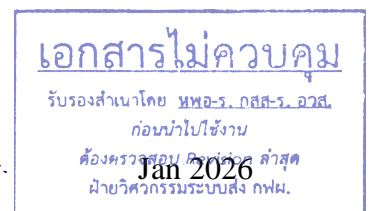

Item	Drawings Title	Approval and Final Dwgs	AutoCAD files	CD-ROM or USB flash drive
1	Drawing list of all drawings submitted for approval	X	-	X
2	Transformer outline including legend of all transformer accessories tabulated in table as shown in Table-1	X	X	X
3	Transformer bottom view showing the skidding base	X	X	X
4	Transformer foundation including location of control cabinet and grounding terminals.	X	X	X
5	Shipping and transportation sketch. (Main tank, LTC tank) including the value of pressure, moisture content and allowable impact figures	X	X	X
6	Transformer nameplate including transformer top and front view with dimension	X	-	X
7	CT connecting plate complete with current ratio	X	-	X
8	Oil temp oil level curve plate	X	-	X
9	Control schematic diagram with terminals indication of each relay, contact, switch, etc. (including list of associated apparatus tabulated in table as shown in Table-2) - AC & DC control - LTC control - LTC motor drive control - Cooling control - Annunciator, alarm & trip circuits with indication of the setting value of all protective devices - LTC oil filter unit control	X	X	X
10	De-energized tap changer	X	-	X
11	Selector switch and control switch position tabulation	X	-	X
12	Drilling plan of parts to be installed at the remote control board combined in one drawing	X	-	X
13	Common control cabinet outline (including indication of accessories location, nameplate of each accessory and annunciator windows with abbreviation of faults)	X	X	X
14	Transformer control cabinet outline (including indication of accessories location, nameplate of each accessory and annunciator windows with abbreviation of faults)	X	X	X

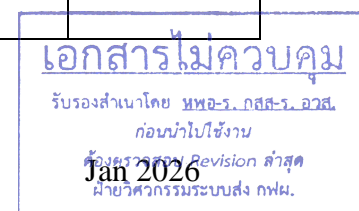
Item	Drawings Title	Approval and Final Dwgs	AutoCAD files	CD-ROM or USB flash drive
15	LTC driving mechanism cabinet and LTC oil filter unit control cabinet outline (including indication of accessories location and nameplate of each accessory)	X	-	X
16	Manual operated voltage setting device outline	X	-	X
17	Lifting device for diverter switch or selector switch	X	-	X
18	Bushing outline (HV, LV, TV, Neutral)	X	-	X
19	Terminal pad of - Bushing (HV, LV, TV, Neutral) - Surge Arrester	X	-	X
20	Grounding terminal connector	X	-	X
21	Terminal blocks layout of real physical arrangement including terminals indication and indication for external connection in : - Common control cabinet - Transformer control cabinet - LTC driving mechanism cabinet - LTC oil filter unit control cabinet	X	X	X
22	Wiring diagram (including internal wiring diagram) - In the common control cabinet - In the transformer control cabinet - In LTC driving mechanism cabinet - Of parts to be installed at the remote control board - In LTC oil filter unit control cabinet	X	X	X
23	Wiring connection of supervisory equipment including indication or wire sizes tabulated in table as shown in Table-3	X	-	X
24	Oil piping and valve connection diagram	X	-	X
25	Grounding connection arrangement with ground wire size indication	X	-	X
26	List of gasket and position with dimension	X	-	X
27	List of spare parts and spare gaskets with shape, quantity and dimension	X	-	X
28	Secondary terminal arrangement of bushing current transformer	X	-	X
29	Test tap outline for all bushings.	X	-	X



**เอกสารไม่ควบคุม**  
 รับรองสำเนาโดย พหจ-ร.กสศ-ร.อวส.  
 ก่อหน้าไปใช้งาน  
 ต้องตรวจสอบ Revision ล่าสุด  
 ฝ่ายวิศวกรรมระบบส่ง กฟผ.  
 24 กุมภาพันธ์ 2569 Jan 2026

Item	Drawings Title	Approval and Final Dwgs	AutoCAD files	CD-ROM or USB flash drive
30	Conservator and Rubber bag with sizing calculation	x	-	x
31	Detailed connection of surge arrester, discharge counter and ground terminal connector	x	-	x
32	Bushing Turret with its dimension and details of BCT	x	-	x
33	Un-tanking sketch (detail for lifting core and coil for maintenance purpose)	x	-	x
34	Sound enclosure (if required)	x	x	x

### B. Document for Approval

1. Description of contact capacity of all relays supplied tabulated in table as shown in Table-4.
2. List of tools and appliances.
3. Load list of transformer control cabinet and common control cabinet.
4. Container list.
5. Package for long term storage of bushing.
6. Verification to confirm that the loss of any fan or any oil pump shall not reduce the output of the transformer by more than 10%, with temperature rises maintained within specified limits.
7. Operating overload curve (such as Time (hr) vs Load (%)) with ambient temperature at 30 and 45 degree Celsius and with starting load from 60%, 80% and 100%
8. Magnetic field plot of transformer

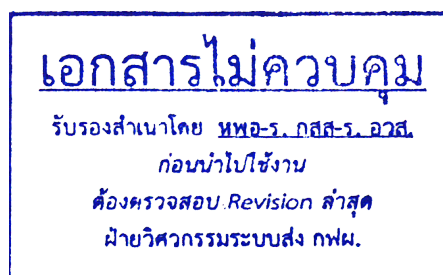
24 กุมภาพันธ์ 2569

Transformer Control Cabinet					
Power Consumption (AC)					
Equipment	Manufacturer	Power Consumption (W)	Qty	Total Power Consumption (W)	Continuous Load (Operate over 3 hrs continuously) Yes / No
1.					
2.					
3.					
4.					
5.					
6.					
7.					
8.					
9.					
Total					

Transformer Control Cabinet					
Power Consumption (DC)					
Equipment	Manufacturer	Power Consumption (W)	Qty	Total Power Consumption (W)	Continuous Load (Operate over 3 hrs continuously) Yes / No
1.					
2.					
3.					
4.					
5.					
6.					
7.					
8.					
9.					
Total					

**เอกสารไม่ควบคุม**  
 รับรองสำเนาโดย **พทอ-ร. กสส-ร. อวส.**  
 ก่อนนำไปใช้งาน  
 ต้องตรวจสอบ Revision ล่าสุด  
 ฝ่ายวิศวกรรมระบบส่ง กฟผ.

24 กุมภาพันธ์ 2569



Common Control Cabinet (for Single Phase)					
Power Consumption (AC)					
Equipment	Manufacturer	Power Consumption (W)	Qty	Total Power Consumption (W)	Continuous Load (Operate over 3 hrs continuously) Yes / No
1.					
2.					
3.					
4.					
5.					
6.					
7.					
8.					
9.					
Total					

Transformer Control Cabinet (for Single Phase)					
Power Consumption (DC)					
Equipment	Manufacturer	Power Consumption (W)	Qty	Total Power Consumption (W)	Continuous Load (Operate over 3 hrs continuously) Yes / No
1.					
2.					
3.					
4.					
5.					
6.					
7.					
8.					
9.					
Total					

**เอกสารไม่ควบคุม**  
 รับรองสำเนาโดย นพอ.ร. กสส.ร. อาส.  
 ก่อนนำไปใช้งาน  
 ต้องตรวจสอบ Revision ล่าสุด  
 ฝ่ายวิศวกรรมระบบส่ง กฟผ.



24 กุมภาพันธ์ 2569

### C. Data and Descriptive Material

- a) Bushing current transformer secondary excitation and ratio correction factor curves for each ratio (Published Characteristic Curve).
- b) Operating description for
  - LTC control
  - LTC motor drive control
  - Parallel Operation
  - Cooling control
  - Annunciating and tripping circuit
- c) Descriptive or catalog data and drawings for
  - On load tap changer
  - Motor drive mechanism
  - Oil filter unit for on load tap changer
  - De-energized tap changer
  - Conservator of transformer tank and LTC compartment
  - Pressure gauge for transportation of transformer tank
  - Three dimensional shock recorder for transportation
  - Pressure relief device
  - Buchholz relay
  - Air detector relay for main conservator
  - Transformer pressure relay
  - LTC pressure relay or LTC oil flow relay
  - Winding temperature relay
  - Winding hot spot temperature detector
  - LTC overcurrent relay
  - Dial type oil level gauge
  - Dial type oil temperature indicator
  - Tap position indicator
  - Multi-tap resistor device
  - Auxiliary tripping and lockout relay
  - Time delay relay for tap changer delay
  - All kinds of auxiliary relay
  - AC & DC undervoltage relay
  - All kinds of selector switch, control switch and push button
  - Manual setting device for setting the desired voltage level
  - Silica gel breather

**เอกสารไม่ควบคุม**

รับรองสำเนาโดย **พทอ-ร. กสส-ร. อวส.**  
ก่อนนำไปใช้งาน

ต้องตรวจสอบ *Revision* สำสุด  
ฝ่ายวิศวกรรมระบบส่ง กฟผ.

24 กุมภาพันธ์ 2569

- All kind of valves
  - Oil sampling device
  - Cooling fan
  - Radiator
  - Transformer gaskets characteristic
  - Insulating oil characteristics
  - Transformer insulation material and pressboard
  - Outlet of 20 A, 250 Vac
- d) **Component Part Data** - One drawing shall be furnished showing the following information, as applicable, for each component part (contactors, relays, auxiliary relays, control devices, switches, etc.)
- Manufacturer
  - Manufacturer's type and/or catalog number
  - Rating
  - Type and number of contacts
  - Contact AC and DC continuous, make and resistive and inductive interrupting ratings
  - Coil impedance and power factor
  - Inrush or starting and continuous or running currents
  - Pickup and dropout times and currents or voltages
  - Operating time delay range if adjustable
  - Expected service life Location
- e) **Curve & Calibration Data Power Frequency** - Where applicable, all curves and calibration data shall be based on a power frequency of 50 Hz. Curves and calibration data based on a power frequency of 60 Hz with an applied correction factor for 50 Hz are not acceptable.



**เอกสารไม่ควบคุม**

รับรองสำเนาโดย ทพอ.ร. กสส.ร. อวส.

ก่อนนำไปใช้งาน

ต้องตรวจสอบ Revision สำสุด

ฝ่ายวิศวกรรมระบบส่ง กฟผ.

24 กุมภาพันธ์ 2569

## 711-29 Instruction Manual for Power Transformer

Instruction manual shall consist of all necessary information and shall comprise of at least the following parts.

### **Part A** Transformer instruction including installation, operation and maintenance manuals.

- a. Transformer general technical information
- b. Installation instruction including but not limited to
  - Moving method for the transformer tank by skidding on the rollers
  - Moving method for complete assembly transformer by skidding on the rollers
  - Inspection including interpretation of shock recorder level
  - Flow chart for installation
  - Installation instruction
  - Allowable exposed time for core and winding
  - Criterion of water content of core and winding
  - Vacuum oil filling
  - Method of drying out at site
  - Characteristic of insulating oil
  - The acceptable value of deviation from factory test value of insulation resistance and insulation power factor after installation at site
  - Tank assembly
  - External assembly for complete transformer
  - Detailed assembly of the sound enclosure at site (if any)
- c. Maintenance and Operation instruction
  - Routine inspection
  - Maintenance
  - Operation guide for current loading
  - Guide for maintenance of long storage transformer
  - Interpretation of gas analysis for transformer in service
  - Assembly and disassembly instructions for on load tap changer complete with component parts list including ordering part numbers, designation of part No and part identification drawing
  - Internal assembly of the transformer
  - Guide for maintenance and inspection of the sound enclosure (if any)



<p><b>เอกสารไม่ควบคุม</b></p> <p>รับรองสำเนาโดย นพอ.ร. กสส.ร. อวส. ก่อนนำไปใช้งาน</p> <p>ต้องตรวจสอบ .Revision ล่าสุด ฝ่ายวิศวกรรมระบบส่ง กฟผ.</p>
------------------------------------------------------------------------------------------------------------------------------------------------------------

24 กุมภาพันธ์ 2569

**Part B** Instructions and manual catalogs including installation and maintenance manual of all accessories.

**Part C** Complete set of all final drawings including description of :

- a. LTC control
- b. LTC motor drive control
- c. Cooling control
- d. Annunciating and tripping circuit

**Part D** Final design data

DRY EXHIBIT

**เอกสารไม่ควบคุม**  
รับรองสำเนาโดย ทพอ.ร.กสศ.ร.อวส.  
ก่อนนำไปใช้งาน  
ต้องตรวจสอบ.Revision ล่าสุด  
ฝ่ายวิศวกรรมระบบส่ง กฟผ.

24 กุมภาพันธ์ 2569

The insulating pressboard offered shall be the products of the manufacturers as follows;

- a. Weidmann of Switzerland
- b. Weidmann Malyn of Ukraine (Moldable pressboard)
- c. Weidmann Jiaxing of China (Moldable pressboard)
- d. Figeholm of Sweden
- e. Oji Specialty Paper of Japan (only type T4 and T37)
- f. Changzhou Yingzhong Electrical Co., Ltd. of China (only Pressboard type B.3.1 A, Laminated pressboard type LB3.1 A.2 and Moldable pressboard)

Nevertheless, the other insulating pressboard manufacturers can additionally be listed in this specification after having been approved by the EGAT Transformer Pressboard Manufacturer Qualification Committee. The procedures for approval can be requested from the Transmission System Engineering Division.



**เอกสารไม่ควบคุม**

รับรองสำเนาโดย **ทพอ.ร.กสศ.ร. อวส.**

ก่อนนำไปใช้งาน

ต้องตรวจสอบ **.Revision** สำสุด

ฝ่ายวิศวกรรมระบบส่ง กฟผ.

24 กุมภาพันธ์ 2569

## Layout for installation of 500 kV Single Phase Transformer

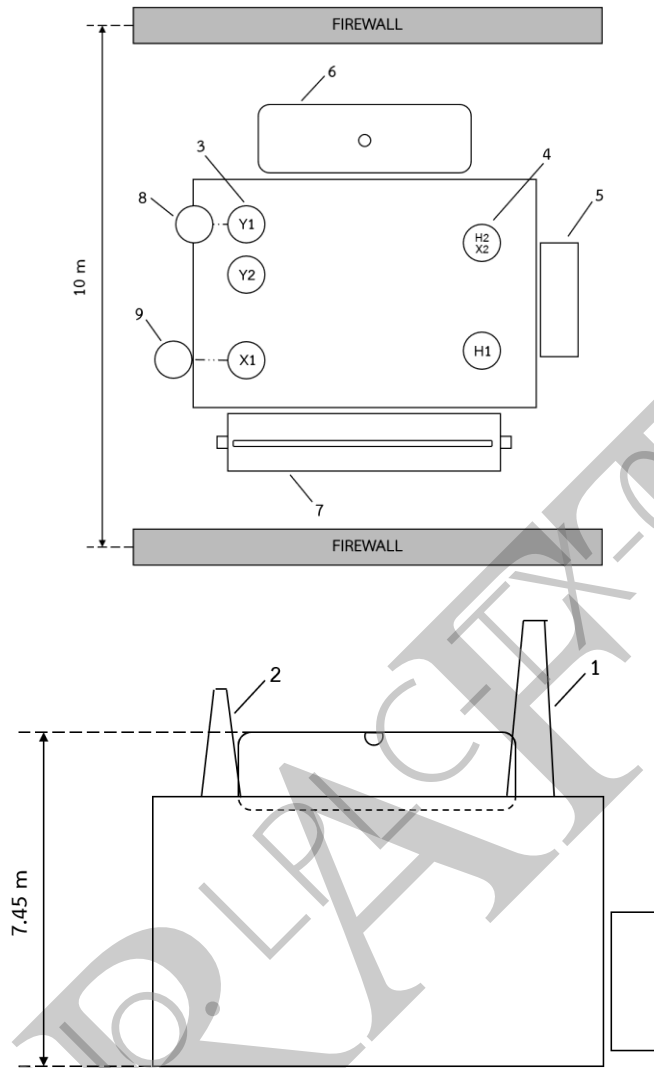

No.	Description
1.	HV Bushing
2.	LV Bushing
3.	TV Bushing
4.	Neutral Bushing
5.	Transformer Control Cabinet
6.	Conservator
7.	Radiator
8.	TV Surge Arrester
9.	LV Surge Arrester

เอกสารไม่ควบคุม

รับรองสำเนาโดย พทอ-ร. กสส-ร. อวส.  
ก่อนนำไปใช้งาน  
ต้องตรวจสอบ Revision คำสุด  
ฝ่ายวิศวกรรมระบบส่ง กฟผ.

24 กุมภาพันธ์ 2569

\* Location of Radiators and Conservator are depended on manufacturer's design

\*\* Surge arrester shall be located on tank wide side (the alignment of all high voltage terminal are parallel to firewall) to provide the electrical clearance with firewall

## Bushings Location for Three Phase Transformer

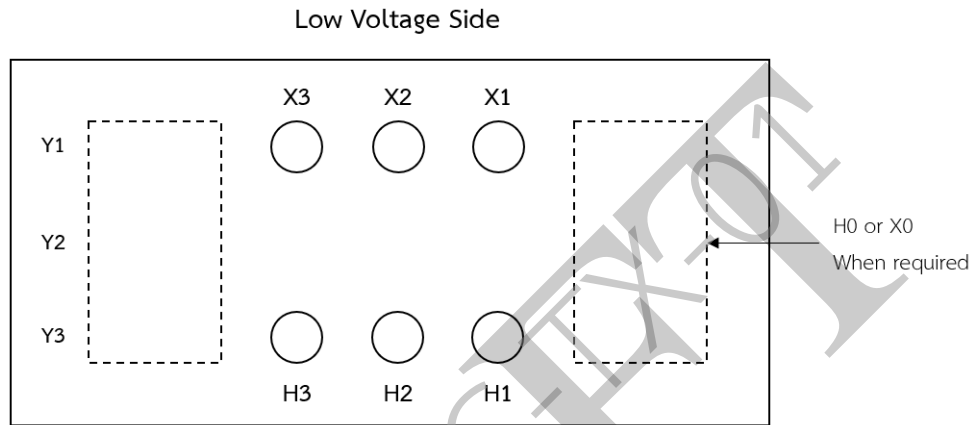

High Voltage Side

LEFT HAND

RIGHT HAND

**เอกสารไม่ควบคุม**

รับรองสำเนาโดย ทพอ.ร.กสศ.ร.อวส.

ก่อนนำไปใช้งาน

ต้องตรวจสอบ .Revision ล่าสุด

ฝ่ายวิศวกรรมระบบส่ง กฟผ.

24 กุมภาพันธ์ 2569

# AC-DC Circuit Arrangement

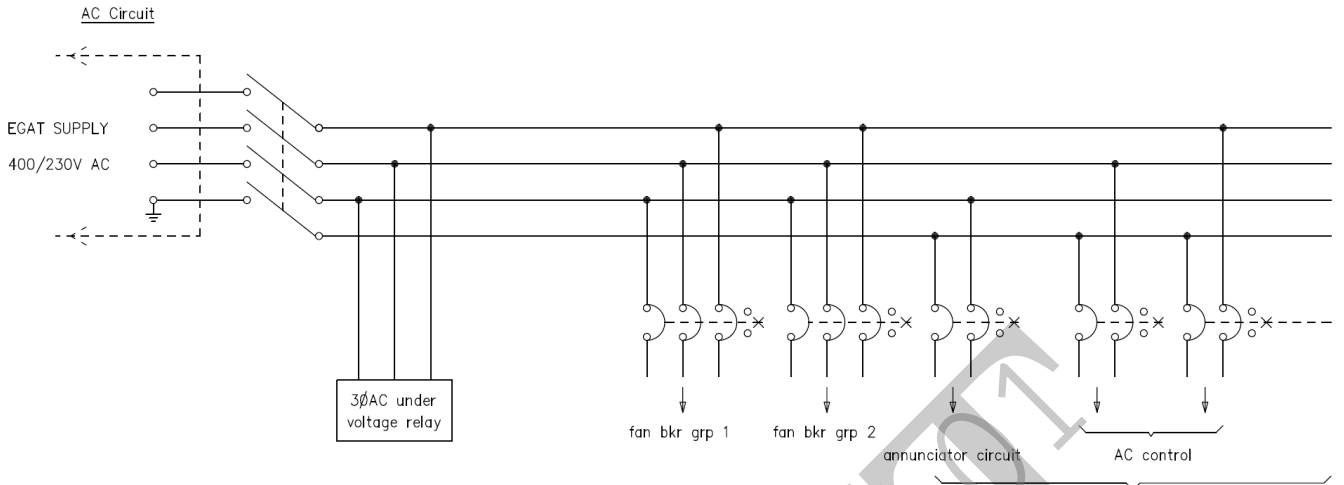

Contact of 3φAC undervoltage shall be connected to show "LOSS OF AC SUPPLY" through DC circuit.

All contacts of AC circuit breakers shall be connected in parallel to show "LOSS OF AC CONTROL PWR" through DC circuit.

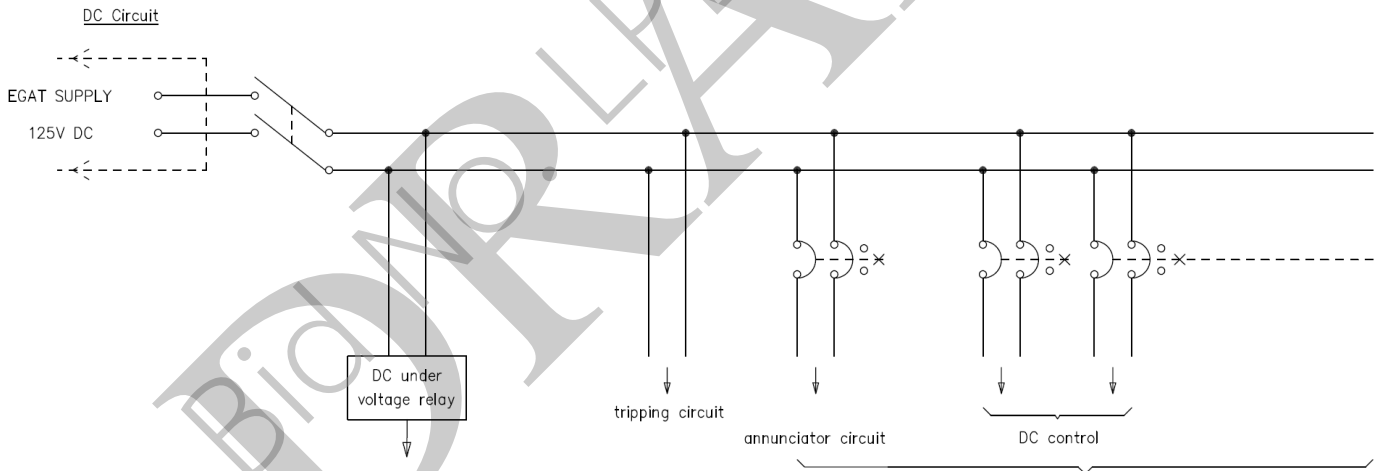

Contact of DC undervoltage relay shall be connected to show "LOSS OF DC SUPPLY" through AC circuit.

All contacts of DC circuit breakers shall be connected in parallel to show "LOSS OF DC CONTROL PWR" through AC circuit.

รูปแบบ Trailer ขนส่งเครื่องจักรและอุปกรณ์หนัก น้ำหนักรวมสินค้าไม่เกิน 271 T.

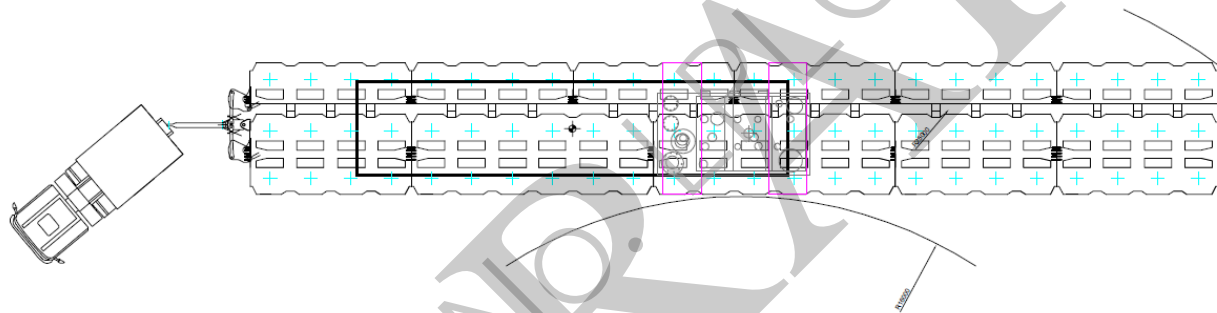
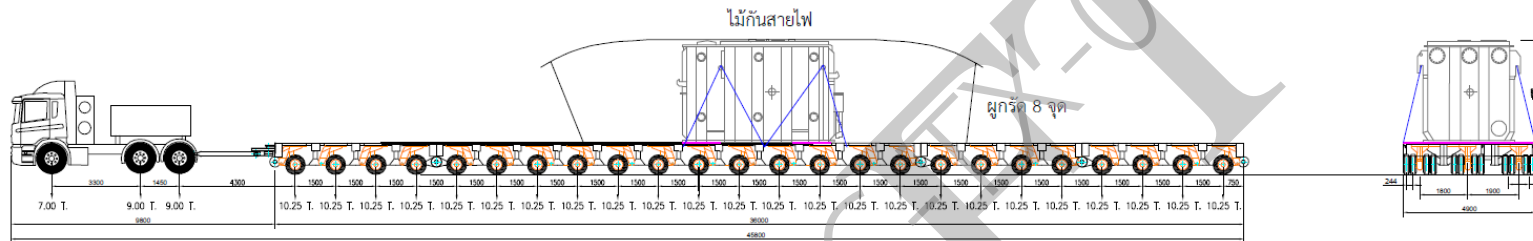

Technical Data	
Hydraulic multi-axle	24A/L (1+1/2)
Platform length	24000 mm.
Inside Turning radius	18000 mm.
Outside Turning radius	25000 mm.
Height	1180±300 mm.
Calculation	
Description	Load (Tons)
TRUCK	13.00
COUNTER WEIGHT	12.00
TRAILER	96.00
CARGO (Limit)	150.00
<b>TRAILER WITH CARGO</b>	<b>246.00</b>
<b>TOTAL</b>	<b>271.00</b>
LOAD/LINE	10.25
LOAD/AXLE	3.41
LOAD/TYRE	1.10
AVG.GROUND PRESSURE	1.39Tons/m2



**EGAT TRANSPORTATION**

แผนกวิศวกรรมขนส่ง กองวิชาการขนส่ง ฝ่ายบริหารงานขนส่ง  
การไฟฟ้าฝ่ายผลิตแห่งประเทศไทย

PROJ.	งานขออนุญาตขนส่งหม้อแปลง 150 ตัน	DRAWING NO.	EGAT-24A/L (1+1/2) -TH62	MRE	mm
DWG TITLE	แบบแปลนเลอร์ 24A/L (1+1/2). บรรทุกอุปกรณ์ไฟฟ้า	LAYOUT	01	DATE	2/07/62
DRAWN	นายภาคย์ คุ้มยิ่ง	SCALE	N/A	REV.	00
		APPR			

SP-711 Rev.1

-711.60-

Jan 2026

**เอกสารไม่ควบคุม**  
รับรองงานไทย นพอ.กตส.ร.อวส.  
ก่อนนำไปใช้งาน  
ต้องตรวจสอบ Revision คำสุด  
ฝ่ายวิศวกรรมระบบส่ง กฟผ.

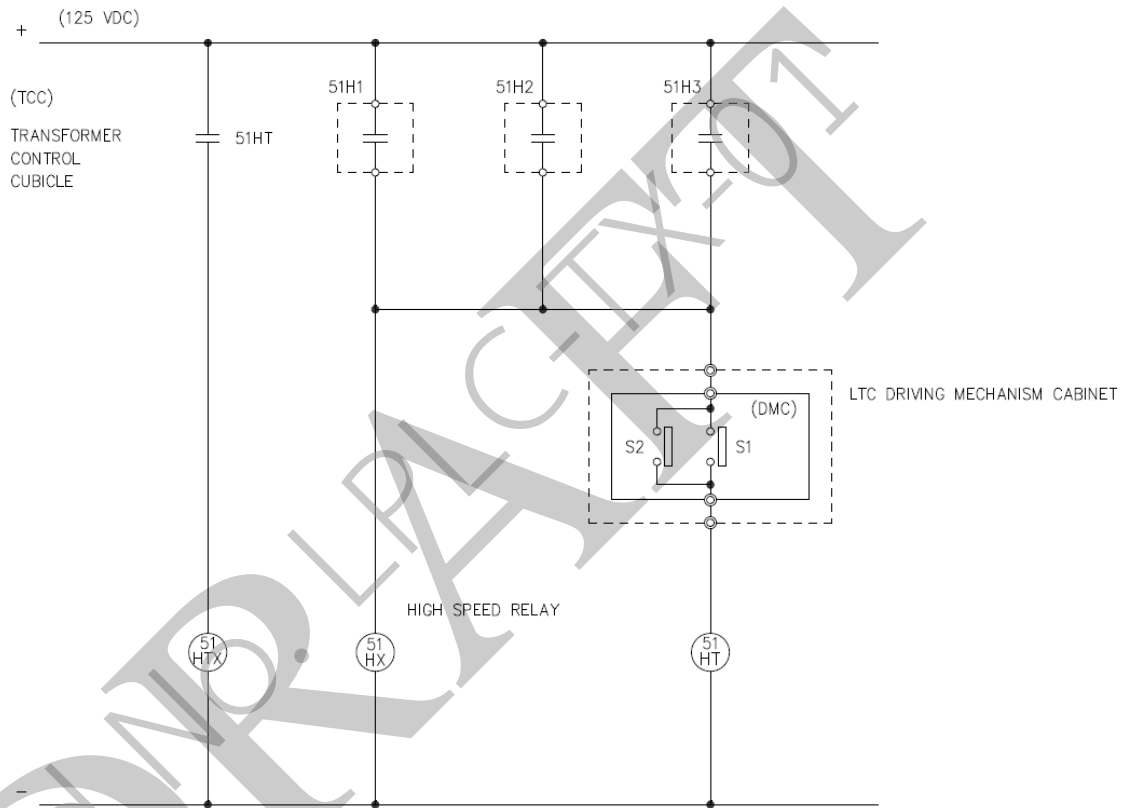

**LEGEND**

LEGEND	DESCRIPTION
51H1, 51H2, 51H3	INSTANTANEOUS AND SELF RESET OVERCURRENT RELAY
51HX	HIGH SPEED RELAY
51HT	TIME DELAY DROP OUT RELAY (ADJUSTABLE TIME 0-60 S.)
51HTX	AUXILIARY RELAY
S1, S2	CAM-OPERATED CONTACT FOR CONTROL DIRECTION

**LOCATION**

TCC
TCC
TCC
TCC
DMC

**เอกสารไม่ควบคุม**  
 รับรองสำเนาโดย นพอ.ร.กฤษระ อวส.  
 ก่อนนำไปใช้งาน  
 ต้องตรวจสอบ Revision ล่าสุด  
 ฝ่ายวิศวกรรมระบบส่ง กฟผ.

24 กุมภาพันธ์ 2569

SUBSTATION ELECTRICAL EQUIPMENT ENGINEERING DIVISION		
LTC OVERCURRENT PROTECTION TYPICAL SCHEMATIC DIAGRAM		
Date : 12/1995	DWG. NO. TX-TSD-01	REV.



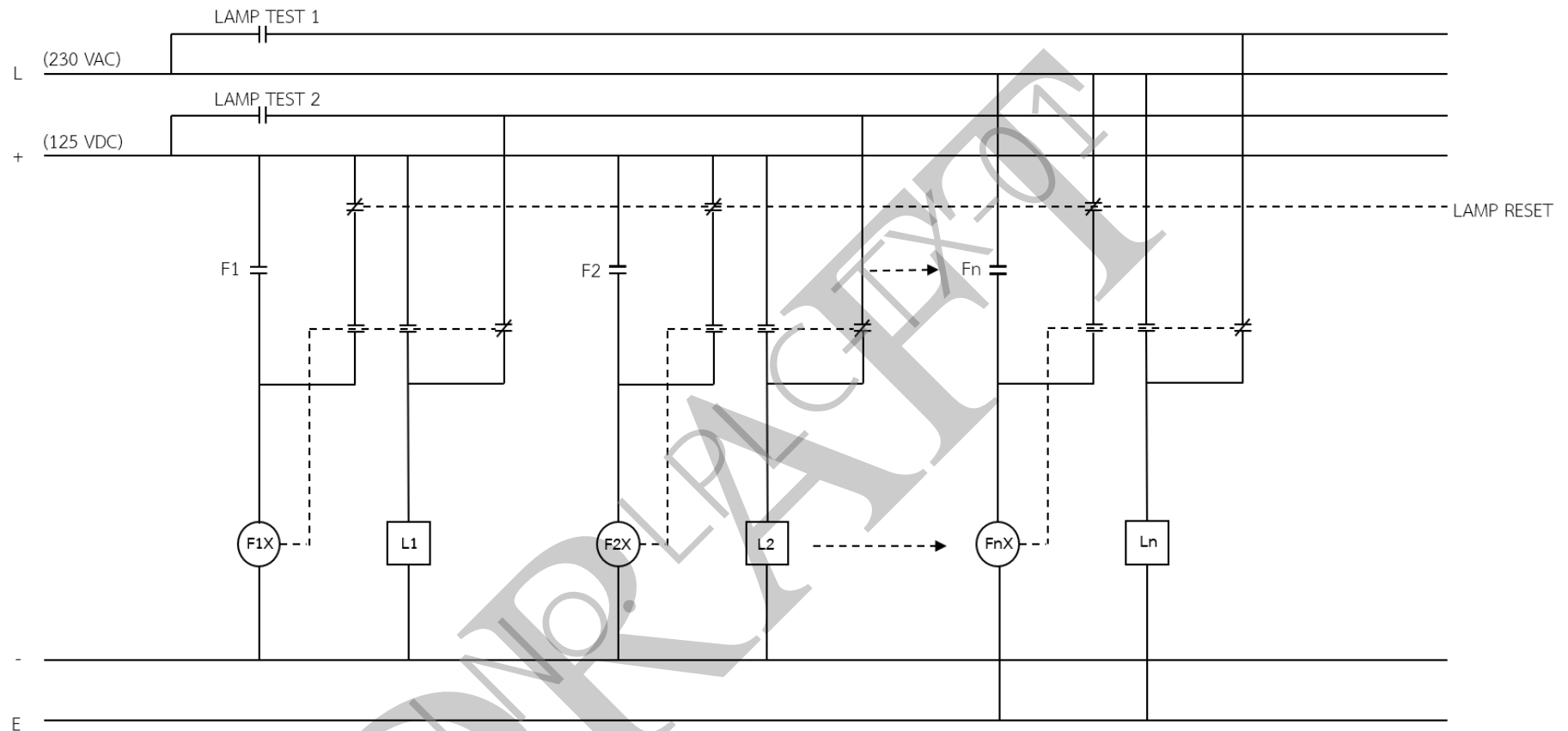

**LEGEND**

F1, F2, ... , Fn  
 F1X, F2X, ... , FnX  
 L1, L2, ... , Ln

**DESCRIPTION**

FAULT CONTACT FROM TRANSFORMER  
 AUXILIARY RELAYS  
 FAULT INDICATIONS ON ANNUNCIATOR

**เอกสารไม่ควบคุม**  
 รับรองสำเนาโดย นพ.ร.กตส.ร.อวส.  
 ก่อนนำไปใช้งาน  
 ต้องตรวจสอบ Revision ล่าสุด  
 ฝ่ายวิศวกรรมระบบส่ง กฟผ.

24 กุมภาพันธ์ 2569

SUBSTATION ELECTRICAL EQUIPMENT ENGINEERING DEPARTMENT			
ANNUNCIATOR			
TYPICAL SCHEMATIC DIAGRAM			
DATE 03/2020	DWG NO.	TX-TSD-03	REV. 0

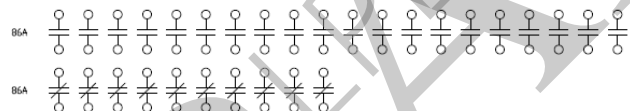
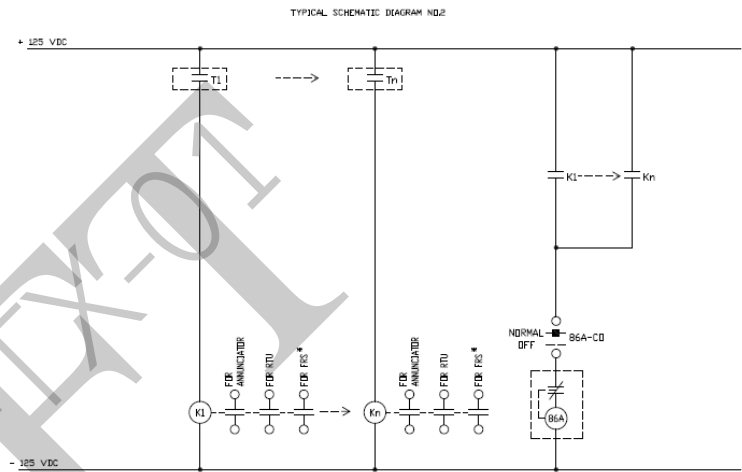
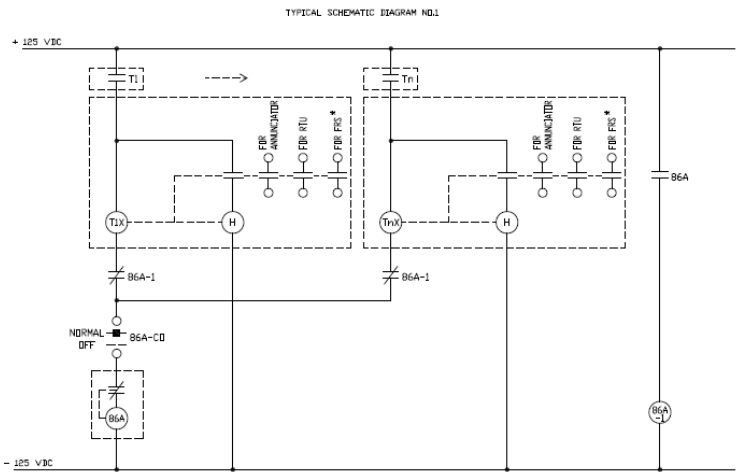

**LEGEND**

T1...Tn TROUBLE CONTACTS FROM TRANSFORMER  
 TLX...TrX CURRENT RELAY WITH HOLDING COIL  
 K1...Kn HIGH SPEED RELAY  
 86A TRIPPING AND LOCKOUT RELAY  
 86A-1 AUXILIARY RELAY  
 86A-CD CUT-OFF SWITCH

**NOTE**  
 \* THE ADDITIONAL CONTACTS (FDR FRS) ARE REQUIRED ONLY IN CASE OF THE SINGLE PHASE AUTO-TRANSFORMER.

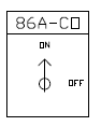

**86A-CD CUT-OFF SWITCH POSITION**

CONTACT	POSITION	
	ON	OFF
1 - 2	X	
3 - 4	X	
5 - 6	X	
7 - 8	X	
9 - 10	X	
11 - 12	X	
13 - 14	X	
15 - 16		X
17 - 18		X
19 - 20		X



REV. NO.	JOB NO.	JOB DESCRIPTION	DRAWN	DESIGNED	VALIDATED	RECOMMENDED	CONCLUDED	APPROVED	DATE
-	-	-	-	-	-	-	-	-	-

ELECTRICITY GENERATING AUTHORITY OF THAILAND			
DRAWN	-	VALIDATED	DRIVING ENGINEER
DESIGNED	-	RECOMMENDED	DRIVING ENGINEER
VIEWED	-	CONCLUDED	DRIVING ENGINEER
APPROVED	-	CONCLUDED	DRIVING ENGINEER
JOB NO.	-	REPLACING DWG. NO.	-
DATE	-	DATE	-
TX - TSD - 04		REV.	4



**เอกสารไม่ควบคุม**  
 รับรองว่าคนไทย หรือ ร.ก. หรือ ร.อ. หรือ  
 ก่อนนำไปใช้งาน  
 ต้องตรวจสอบ Revision คำพูด  
 ฝ่ายวิศวกรรมระบบส่ง กฟผ.

# WINDING ARRANGEMENT DATA

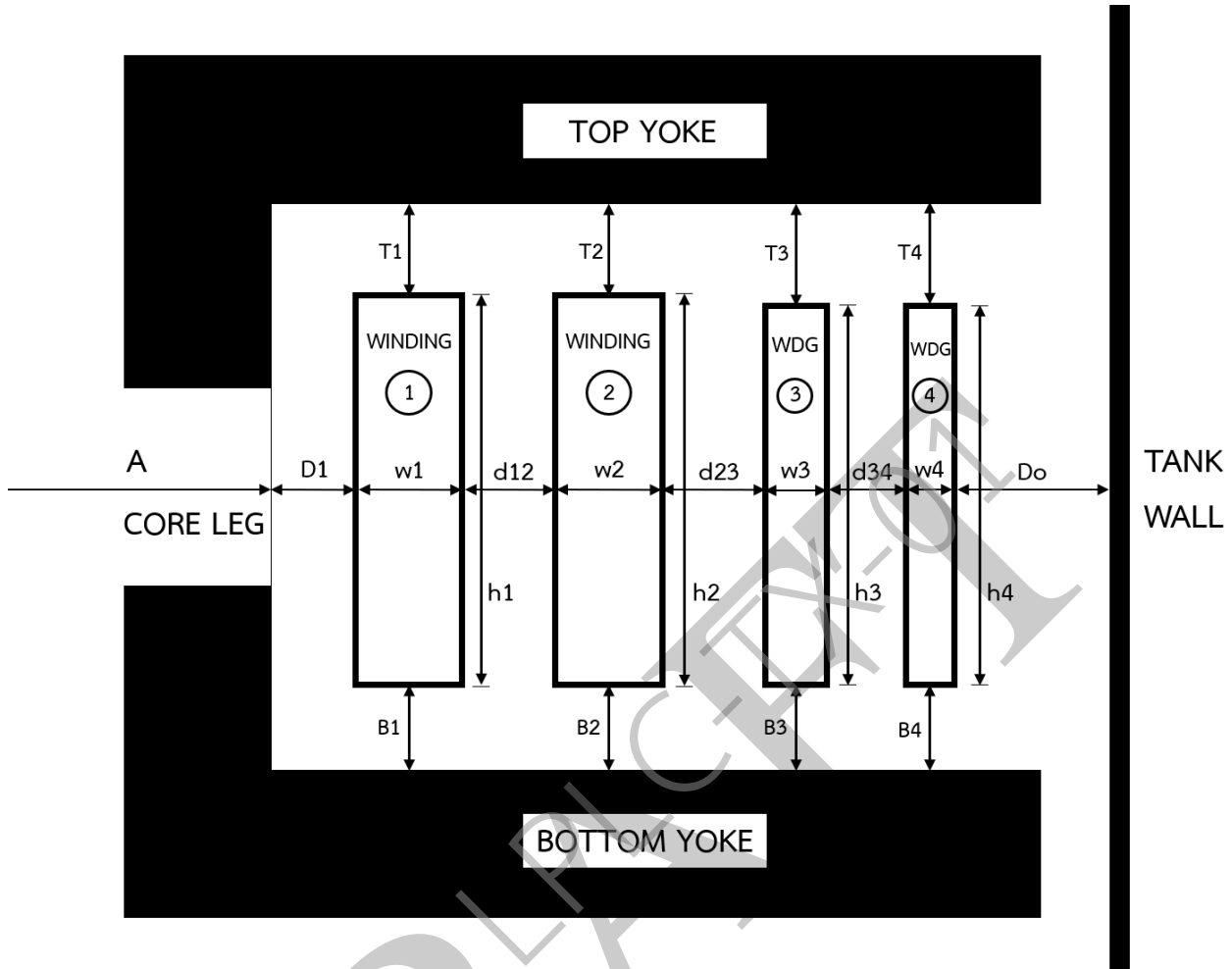

WINDING DATA	WINDING 1	WINDING 2	WINDING 3	WINDING 4
Name of Winding (Series, Common, Tap, TV, LV, HV, etc.)	.....	.....	.....	.....
Winding Width	w1 = .....	w2 = .....	w3 = .....	w4 = .....
Winding Height (Coil Part Only)	h1 = .....	h2 = .....	h3 = .....	h4 = .....
Distance from Top Yoke	T1 = .....	T2 = .....	T3 = .....	T4 = .....
Distance from Bottom Yoke	B1 = .....	B2 = .....	B3 = .....	B4 = .....
Distance Between Winding		d12 = .....	d23 = .....	d34 = .....
Distance of Innermost Winding from Core Leg				D1 = .....
Distance of Outermost Winding to Tank Wall				Do = .....
Core Leg Diameter				.....

NOTE 1. All dimensions are in millimeters.

**เอกสารไม่ควบคุม**

รับรองสำเนาถูกต้องโดย ร.กสส.ร.อวส.  
ก่อนนำไปใช้งาน  
ต้องตรวจสอบ Revision ล่าสุด  
ฝ่ายวิศวกรรมระบบส่ง กฟผ.

Jan 2026

**COIL CONDUCTOR DATA FOR EACH WINDING**

Name of Winding (Series, Common, Tap, TV, LV, HV, etc.)				
Type of Winding (Disc, Layer, Helical, etc.)				
Type of Conductor (Rectangular, CTC, Bonded CTC, etc.)				
Number of Turns				
Number of Disk or Layer				
Number of Turns per Disk or Layer				
Number of Conductor or Cable per Turn				
Conductor per Turn Data (Describe) <ul style="list-style-type: none"> <li>- Total Cross Section Area of Conductor (mm<sup>2</sup>)</li> <li>- Number of Strand per Conductor</li> <li>- Conductor Strand Dimensions (mm x mm)</li> <li>- Modulus of Elasticity (E, kg/cm<sup>2</sup>)</li> <li>- Stiffness (EI Product) of Stranded Conductor in Percent of Equivalent Solid Copper Bar</li> </ul> <u>Note</u> E = Modulus of Elasticity I = Moment of Inertia <ul style="list-style-type: none"> <li>- Proof Stress with Permanent Elongation of 0.2% (<math>\sigma_{0.2}</math>) of Copper (kg/cm<sup>2</sup>)</li> <li>- Strand Insulating Paper Thickness (mm)</li> <li>- Cable Insulating Paper Thickness (mm)</li> </ul>				
Radial Spacer Block <ul style="list-style-type: none"> <li>- Number of Spacer Between Disk</li> <li>- Spacer Width (mm)</li> <li>- Spacer Pitch (mm) <ul style="list-style-type: none"> <li>• at outermost diameter center to center</li> </ul> </li> <li>- Total Surface Area Between Disk (mm<sup>2</sup>)</li> </ul>				
Axial Spacer Column Under Winding <ul style="list-style-type: none"> <li>- Number of Spacer Under Winding</li> <li>- Spacer Width x Thickness (mm x mm)</li> </ul>				
Winding Resistance per Phase ( $\Omega$ /Phase at 80°C) Conductor Weight per Phase (kg)				
Are there any axial spacer columns (cooling ducts) between turns or layer? If yes, please show details. For instance, in a disk winding which has 6 turns per disk inserted with cooling duct between every 2 turns shall be specified as 2 / 2 / 2 If yes, please specify mean diameter of the outermost and innermost segment of each winding.				



**เอกสารไม่ควบคุม**

รับรองสำเนาโดย นพอ.ร. กสส.ร. อวส.  
**Jan 2026**  
ต้องตรวจสอบ.Revision ล่าสุด  
ฝ่ายวิศวกรรมระบบส่ง กฟผ.

Table-1

Item	Qty.	Description	Rating	Type	Manufacturer	Catalog or Dwg. No.	Remark (if any)
1	3	HV Bushing					
2	3	LV Bushing					

Table-2

Legend	Qty.	Description	Rating	Type	Location				Manufacturer	Remark (if any)
					RCB	CCC	TCC	DMC		
86A	1	Aux. tripping and lockout relay								

Table-3

Legend	Qty.	Description	Wire size (mm <sup>2</sup> )	Number of wire	Terminal mark	Remark (if any)
	1	Winding temp relay	3.5			
	2	HV BCT	5.5			

Table-4

Legend	Description	Operating time (ms.)	Contact type	Current Capacity (A)						Expected Service Life	Manu. of	Remark (if any)
				V AC			125V DC					
				Continuous	Making	Breaking	Continuous	Making	Breaking			
	Winding temp. relay		Mercury switch									
	Buchholz relay		Micro switch									

**เอกสารไม่ควบคุม**  
 รับรองสำเนาโดย นพอ.ร. กสส.ร. อวส.  
 ก่อนนำไปใช้งาน  
 ต้องตรวจสอบ Revision ล่าสุด  
 ฝ่ายวิศวกรรมระบบส่ง กฟผ.

24 กุมภาพันธ์ 2569

PHASE TRANSFORMER ANNUNCIATOR  
TROUBLE & TRIPPING SCHEDULE

Item	Trouble	Annunciator Window Legend	Tripping
1	Main tank oil temperature high	MAIN TANK OIL TEMP HI	
2	Main tank oil level low	MAIN TANK OIL LEVEL LO	
3	Main tank oil level high	MAIN TANK OIL LEVEL HI	
4	LTC diverter switch oil level low	LTC DIV SW OIL LEVEL LO	
5	Main tank pressure relief device operation	MAIN TANK PRESS RELIEF ALARM	
6	LTC diverter switch pressure relief device operation	LTC DIV SW PRESS RELIEF ALARM	
7	Winding temperature alarm stage 1	WDG TEMP ALARM STG 1	
8	Winding temperature alarm stage 2	WDG TEMP ALARM STG 2	
9	Buchholz relay operation (alarm)	BUCHHOLZ RLY ALARM	
10	Buchholz relay operation (trip)	BUCHHOLZ RLY TRIP	yes
11	Main tank sudden pressure relay operation	SUDDEN PRES ALARM	
12	Conservator rubber bag rupture detector relay operation	RUBBER BAG RUPTURE	
13	LTC pressure relay or oil flow relay operation	LTC PRES RLY TRIP OR OIL FLOW RLY TRIP	yes
14	Loss of three phase AC control power (three phase undervoltage relay)	LOSS OF AC SUPPLY	
15	Loss of DC control power (undervoltage relay)	LOSS OF DC SUPPLY	
16	Branch AC control power ACB trip (ACB alarm contacts)	LOSS OF AC CONTROL PWR	

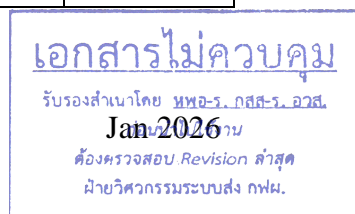
PHASE TRANSFORMER ANNUNCIATOR

TROUBLE & TRIPPING SCHEDULE

Item	Trouble	Annunciator Window Legend	Tripping
17	Branch DC control power ACB trip (ACB alarm contacts)	LOSS OF DC CONTROL PWR	
18	LTC tap change operation incomplete	TAP CHANGE INCOMPLETE	
19	Group 1 fan motor overload	GRP1 FAN MOTOR OVERLOAD	
20	Group 2 fan motor overload	GRP2 FAN MOTOR OVERLOAD	
21	Group 1 fan motor circuit breaker trip	GRP1 FAN MOTOR BRK TRIP	
22	Group 2 fan motor circuit breaker trip	GRP2 FAN MOTOR BRK TRIP	
23	LTC drive motor circuit breaker trip	LTC DRIVE MOTOR BRK TRIP	
24	Misoperation of the de-energized tap changer	DE-ENERGIZED TAP CHANGE MISOPERATION	yes



**เอกสารไม่ควบคุม**  
 รับรองสำเนาโดย พทอ.ร. กสส.ร. อวส.  
 ก่อนนำไปใช้งาน  
 ต้องตรวจสอบ .Revision ล่าสุด  
 ฝ่ายวิศวกรรมระบบส่ง กฟผ.

24 กุมภาพันธ์ 2569

COMMON TRANSFORMER ANNUNCIATOR  
TROUBLE & TRIPPING SCHEDULE

Item	Trouble	Annunciator Window Legend
1	Low of three phase AC control power (three phase undervoltage relay)	LOSS OF AC SUPPLY
2	Loss of DC control power (undervoltage relay)	LOSS OF DC SUPPLY
3	Branch AC control power ACB trip (ACB alarm contacts parallel)	LOSS OF AC CONTROL PWR
4	Branch DC control power ACB trip (ACB alarm contacts parallel)	LOSS OF DC CONTROL PWR
5	Overcurrent block of LTC operation during tap change	OVERCURRENT DURING TAP CHANGE
6	LTC tap position discrepancy between phases	PHASE TAP DISCREPANCY
7	Parallel operation LTC tap position discrepancy	PARALLEL TAP DISCREPANCY
8	Phase A annunciator operated (annunciator common alarm contact)	PHASE A TROUBLE
9	Phase B annunciator operated (annunciator common alarm contact)	PHASE B TROUBLE
10	Phase C annunciator operated (annunciator common alarm contact)	PHASE C TROUBLE
11	Operation of lock out relay	LOCK OUT OPERATE
12	Cut off switch 86ACO – off position	CUT OFF SW. OPERATE

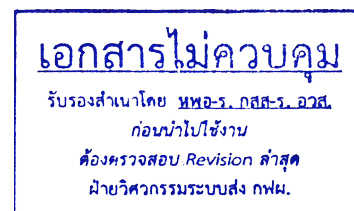
**TRANSFORMER CONTROL CABINET**  
**ANNUNCIATOR TROUBLE & TRIPPING SCHEDULE**  
(For Three phase transformer)

Item	Trouble	Annunciator Window Legend	Tripping
1	Main tank oil temperature high	MAIN TANK OIL TEMP HI	
2	Main tank oil level low	MAIN TANK OIL LEVEL LO	
3	Main tank oil level high	MAIN TANK OIL LEVEL HI	
4	LTC diverter switch oil level low	LTC DIV SW OIL LEVEL LO	
5	Main tank pressure relief device operation	MAIN TANK PRES RELIEF ALARM	
6	LTC diverter switch pressure relief device operation	LTC DIV SW PRES RELIEF ALARM	
7	Winding temperature alarm stage 1	WDG TEMP ALARM STG 1	
8	Winding temperature alarm stage 2	WDG TEMP ALARM STG 2	
9	Buchholz relay operation (ALARM)	BUCHHOLZ RLY ALARM	
10	Buchholz relay operation (TRIP)	BUCHHOLZ RLY TRIP	yes
11	Main tank sudden pressure relay operation	SUDDEN PRES ALARM	
12	Conservator rubber bag rupture detector relay operation	RUBBER BAG RUPTURE	
13	LTC pressure relay or oil flow relay operation	LTC PRES RLY TRIP OR OIL FLOW RLY TRIP	yes
14	Loss of three phase AC control power (three phase undervoltage relay)	LOSS OF AC SUPPLY	
15	Loss of DC control power (undervoltage relay)	LOSS OF DC SUPPLY	

**TRANSFORMER CONTROL CABINET**  
**ANNUNCIATOR TROUBLE & TRIPPING SCHEDULE**  
(For Three phase transformer)

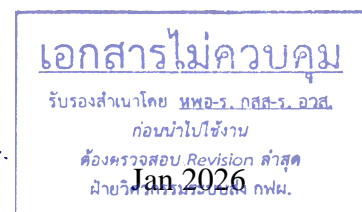
Item	Trouble	Annunciator Window Legend	Tripping
16	Branch AC control power ACB trip (ACB alarm contacts)	LOSS OF AC CONTROL PWR	
17	Branch DC control power ACB trip (ACB alarm contacts)	LOSS OF DC CONTROL PWR	
18	Overcurrent block of LTC operation during tap change	OVERCURRENT DURING TAP CHANGE	
19	Change-delay of LTC	TAP CHANGE DELAY	
20	Deviation of tap position	TAP DIFF	
21	Group 1 fan motor overload	GRP1 FAN MOTOR OVERLOAD	
22	Group 2 fan motor overload	GRP2 FAN MOTOR OVERLOAD	
23	Group 1 fan motor circuit breaker trip	GRP1 FAN MOTOR BRK TRIP	
24	Group 2 fan motor circuit breaker trip	GRP2 FAN MOTOR BRK TRIP	
25	LTC drive motor circuit breaker trip	LTC DRIVE MOTOR BRK TRIP	
26	Misoperation of the de-energized tap changer	DE-ENERGIZED TAP CHANGE MISOPERATION	yes
27	Breaker for LTC oil filter pump motor failure	LTC OIL FILTER PUMP BKR.	
28	Oil filter pressure switch operation	OIL FILTER OVERPRESSURE	
29	Operation of lock out relay	LOCK OUT OPERATE	
30	Cut off switch 86ACO – off position	CUT OFF SW. OPERATE	

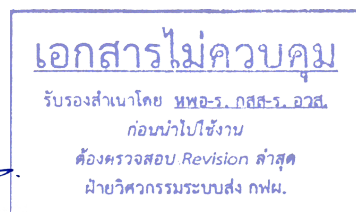

## SPECIFICATION OF MINERAL INSULATING OIL

### REVISION 7.3.1

#### 1. General

The new mineral insulating oil obtained by refining, modifying and/or blending of original petroleum products is used as an insulating and cooling medium in new and existing power as well as distribution electrical apparatus, such as transformers, regulators, reactors, circuit breakers, switchgears, and attendant equipment where greater oxidation resistance is required. The mineral insulating oil shall be functionally interchangeable, miscible with existing oil, compatible with existing apparatus and with appropriate field maintenance. It shall satisfactorily maintain its functional characteristics in its application in electrical equipment. This specification applies only to new insulating oil which is received before any processing.

#### 2. Property Requirements

The property requirements of mineral insulating oil shall conform to ASTM D3487-2016e1 Type II Mineral oil (see Clause 3.1.2 for definitions of ASTM or IEC60296-2020 Edition 5.0 Type A Mineral oil (see Clause 5.1 for definitions of IEC) and EGAT experiences. Inhibited oil is insulating oil which has been supplemented with 2,6-ditertiary-butyl phenol or 2,6-ditertiary-butyl para-cresol or any other specified and acceptable oxidation inhibitor. If other additives are used, they must be identified. Generally, the additive is a suitable chemical substance which is deliberately added into the mineral insulating oil to improve certain characteristics. So, the use of all additives, such as pour point depressants, gassing tendency improvers, additives for static electrification, antifoaming agents and other additives, should be specifically identified by class of compounds if the specific information is proprietary, except the additive for this specification must be free from additive for corrosive sulfur.

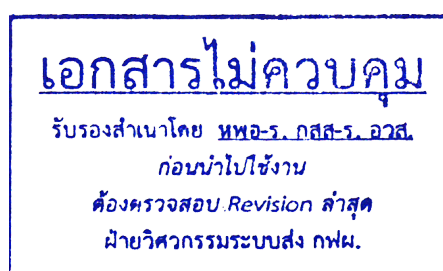

24 กุมภาพันธ์ 2569

Property		ASTM D 3487 Requirements	IEC 60296 Requirements	*EGAT Requirements
2.1	Color	0.5, max	L0.5 (less than 0.5)	-
2.2	Flash point, °C	145, min	135, min	-
2.3	Interfacial Tension at 25 °C dynes/cm (mN/m)	40, min	43, min	-
2.4	Pour point, °C	-40, max <sup>(B)</sup>	-40, max	-
2.5	Relative density (Specific gravity) 15°C/15°C, g/ml	0.91, max	-	-
2.6	Density at 20°C, g/ml	-	0.895, max	-
2.7	Viscosity, Kinematics cSt (SUS) at 100°C at 40°C at 0°C at -30°C	3.0 (36), max 12.0 (66), max 76.0 (350), max -	- 12.0, max - 1,800, max	- - - -
2.8	Visual examination	clear and bright	-	-
2.9	Appearance	-	clear, free from sediment and suspended matter	-
2.10	Dielectric breakdown voltage VDE electrodes, kV 0.040 in (1.02 mm.) gap 0.080 in (2.03 mm.) gap	20, min <sup>(D)</sup> 35, min <sup>(D)</sup>	- -	20, min <sup>(A)</sup> 35, min <sup>(A)</sup>
2.11	Dielectric breakdown voltage, kV	-	30, min	See note EGAT Requirements <sup>(A)</sup>
2.12	Dielectric breakdown voltage, Impulse conditions Negative polarity point, kV	145, min	-	145, min See note EGAT Requirements <sup>(B)</sup>

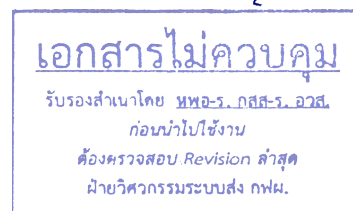

	Property	ASTM D 3487 Requirements	IEC 60296 Requirements	*EGAT Requirements
2.13	Gassing Tendency, $\mu\text{L}/\text{min}$	+30, max	-	See note EGAT Requirements <sup>(C)</sup>
2.14	Power factor (Dissipation factor) at 60 Hz, % at 25 °C at 90 °C at 100 °C	0.05, max - 0.30, max	- 0.005, max -	- - -
2.15	Neutralization number, Total acid number, Acidity mg KOH/g	0.03, max	0.01, max	-
2.16	Oxidation stability (acid-sludge test) 72 hrs: % sludge, by mass Total acid number, mg KOH/g 164 hrs: % sludge, by mass Total acid number, mg KOH/g	0.1, max 0.3, max 0.2, max 0.4, max	- - - -	- - - -
2.17	Oxidation stability IEC 61125: Test duration (I) Inhibited oil: 500 h Total acidity, mg KOH/g Sludge, % DDF at 90° C	- - -	0.3, max <sup>(h)</sup> 0.05, max <sup>(h)</sup> 0.050, max <sup>(h)</sup>	- - -
2.18	Oxidation stability (pressure vessel test), (Rotating Bomb), minutes	195, min	-	220, min <sup>(D)</sup>
2.19	Oxidation inhibitor content % by mass	0.30, max <sup>(G)</sup>	0.08-0.40	-

### เอกสารไม่ควบคุม

รับรองสำเนาโดย ทพอ-ร. กสส-ร. อวส.

ก่อนนำไปใช้งาน

ต้องตรวจสอบ Revision ล่าสุด

ฝ่ายวิศวกรรมระบบส่ง กฟผ.

24 กุมภาพันธ์ 2569

Property		ASTM D 3487 Requirements	IEC 60296 Requirements	*EGAT Requirements
2.20	2-Furfural and related compounds content, µg/l	25, max per compound	Not detectable (< 0.05 mg/kg) for each individual compound	25, max <sup>(E)</sup> (for each individual compound)
2.21	Corrosive sulfur copper strip, 150 °C 48 hrs Potentially corrosive copper conductor wrapped with paper, 150 °C±2°C 72 hrs, evaluation of -copper -paper	Non-Corrosive  - -	-  Non-Corrosive No deposits	Non-Corrosive <sup>(F)</sup>  Non-Corrosive <sup>(F)</sup> No deposits
2.22	Dibenzyl disulfide (DBDS), mg/kg	-	Not detectable (<5 mg/kg)	Not detectable (<5 mg/kg)
2.23	Water content, ppm	35, max	30, max	-
2.24	% PCA content (Polycyclic aromatics)	-	3, max	-
2.25	PCB content	Not detectable	Not detectable (<2 mg/kg)	-
2.26	% Total Sulphur content	-	0.05, max	-
2.27	Stray gassing under thermo-oxidative stress	-	Non stray gassing	-

\*in case of any test item meets EGAT Requirements, that limit becomes accepted.



### เอกสารไม่ควบคุม

รับรองสำเนาโดย ทพอ.ร. กสส.ร. อวส.  
ก่อนนำไปใช้งาน  
ต้องตรวจสอบ Revision สำสุด  
ฝ่ายวิศวกรรมระบบส่ง กฟผ.

24 กุมภาพันธ์ 2569

**Note:**

**ASTM D 3487 Requirements**

- <sup>(B)</sup> It is common practice to specify a lower or higher pour point, depending upon climatic conditions.
- <sup>(D)</sup> These limits by Test Method D 1816 are applicable only to as received new oil.
- <sup>(G)</sup> Both 2,6-ditertiary-butyl para-cresol and 2,6-ditertiary-butyl phenol have been found to be suitable oxidation inhibitors for use in oils meeting this specification.

**IEC 60296 Requirements**

- <sup>(h)</sup> At the end of oxidation stability tests.

**EGAT Requirements**

- <sup>(A)</sup> These limits by Test Method ASTM D1816 are applicable only to as received new oil.
- <sup>(B)</sup> EGAT prefers oil of a 145 kV minimum for certain applications.
- <sup>(C)</sup> The characteristic should be negative. If the characteristic is positive, the value should be near test report from supplier ( $\pm 10\%$ ). In case the characteristic is positive, this oil cannot be used in Instrument transformer and bushing.
- <sup>(D)</sup> Good oxidation stability is a principal requirement for long service life of transformer oils.
- <sup>(E)</sup> The test is for five furanic compounds, 5-hydroxymethyl-2-furfural, furfuryl alcohol, 2-furfural, acetyl furan and 5-methyl-2-furfural. The limit of 25  $\mu\text{g/L}$  maximum applies to each compound.
- <sup>(F)</sup> Classification of corrosive or non-corrosive shall be made using ASTM copper strip corrosion standards as referred to test method ASTM D130.



**เอกสารไม่ควบคุม**

รับรองสำเนาโดย **ทพอ-ร. กสส-ร. อวส.**

ก่อนนำไปใช้งาน

ต้องตรวจสอบ *Revision* สำคัญ

ฝ่ายวิศวกรรมระบบส่ง กฟผ.

24 กุมภาพันธ์ 2569

### 3. Container

The mineral insulating oil shall be filled in non-returnable, 200 liters steel drums which shall become the property of EGAT. The filling date of insulating oil shall be declared on each drum.

#### Steel Drums 200 Liters (Tight Head)

For the packing of	Transformer oil
Nominal Capacity (Litres)	200
Nominal Capacity (Gallon)	55
Max Capacity (Litres)	217
Raw Material	Cold Rolled Steel Spec.: JIS.G. 3141 SPCC-SD (Prime A.)
Thickness Body (mm)	0.9 ± 0.06
Thickness Top/Bottom (mm)	1.2 ± 0.08
Overall Height (mm)	887
Closure (mm)	51 (2") and 19 (3/4")
Surface Inside	Plain steel or Unlined
Surface Outside	Painted with single color or multicolor, Decorated to top, bodies, and bottom
Weight (kg)	17.5

4 oil drums per pallet with secure packaging shall be provided and suitable for transportation. The pallet's dimension shall be 1.20 x 1.20 meters.

### 4. Acceptance Tests

The mineral insulating oil shall be tested to confirm all characteristics as specified. The number of samples examined for each item is shown in the attachment sheet No.1 and No.2. The oil will be accompanied with a statement form of the Bidder to guarantee its characteristics. EGAT shall have the right to reject all products if the samples do not pass the process of examination. EGAT shall test in some items (item 2.1, 2.3, 2.5-2.12, 2.14-2.15, 2.18-2.23, 2.25) and consider another item (item 2.2, 2.4, 2.13, 2.16, 2.17, 2.24) from product data sheet or technical data sheet of each company.

The sampling of mineral insulating oil shall be performed by the supplier and witnessed by EGAT with the sampling device and procedures according to ASTM D923 or IEC 60567. The supplier shall provide six dry and clean 1000 cc. glass bottles for each sampling

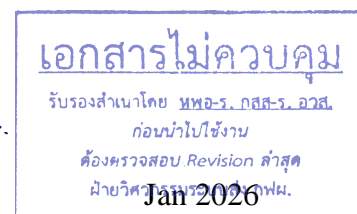

drum. In case of negative test results are from the sampling process or from the sampling device, the supplier shall take the responsibility.

The problem on sampling mineral insulating oil can be caused by unclean and wrong vessel during the sampling procedures so the supplier or trader must be informed of this regard.

The criteria for consideration of test result shall be performed as follows:

- The mineral insulating oil is submitted to EGAT by the supplier.
- When the samplings of mineral insulating oil are taken to test by EGAT and the test results do not become satisfactory, the supplier has to take the mineral insulating oil back immediately without any re-test. In other words, EGAT will perform the test without any charge to the supplier only. If EGAT does not satisfy with the result after the first testing, the suppliers shall take the mineral insulating oil back for improvement or change a new sampling and shall re-submit to EGAT only once. For the second submission, if the supplier wants EGAT to test the sampling again, he shall bear the testing cost as shown in attachment No.2 or if the supplier wants EGAT to send the sampling to be tested by the third-party office accepted by EGAT, he shall bear for any cost that occurs.

#### **5. Product Data Sheet or Technical Data Sheet and Test Report**

Bidder shall submit, at the time of bidding, the product data sheet or the technical data sheet from the original maker, together with the latest test report of the proposed mineral insulating oil, according to the EGAT's requirement.

The approved vender shall inform, to EGAT, the number of lots or batches of the mineral insulating oil prior to submitting to be tested. The test report of each lot or batch shall be submitted with the product shipment.

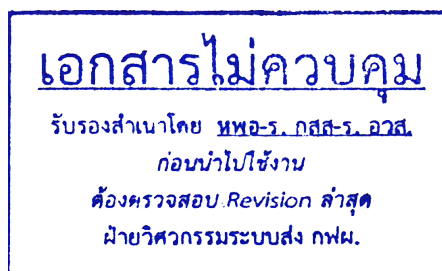

24 กุมภาพันธ์ 2569

## Specification No 741

### Metal Oxide Surge Arresters

**741-1 General.** This specification covers the general requirement for design, manufacture, test and supply of metal oxide surge arrester.

The specific ratings, characteristics and the special requirements and features of the equipment not covered herein are given in the accompanying Ratings and Features sheet (if any).

**741-2 Materials and Workmanship.** All materials shall be new and shall be the best available for the purposes used, considering strength, ductility, durability and suitability for the intended services and best engineering practice. Workmanship shall be of the highest grade and in accordance with the best modern standard practice.

**741-3 Service Conditions.** All materials shall be suitable for installation and use at an altitude of 1000 m or less in a tropical climate with a maximum ambient temperature of 45°C and 100% relative humidity for outdoor equipment (or a maximum ambient temperature of 40°C and 90% relative humidity for indoor equipment) without corrosion, deterioration or degradation of performance characteristics.

**741-4 Codes and Standards.** All equipment, materials, devices, fabrication and testing shall conform to the codes, specifications and standards listed below and all applicable codes, specifications and standard referred therein.

ANSI	American National Standards Institute
ASME	American Society of Mechanical Engineers
ASTM	American Society for Testing and Materials
AWS	American Welding Society
IEC	International Electrotechnical Commission
IEEE	The Institute of Electrical and Electronics Engineers
NEMA	National Electrical Manufacturers Association

All threaded parts requiring external connection shall have metric screw and pipe threads. All internal parts may have threads in accordance with the established specification in the country of manufacturer.

It is the intent that all equipment, materials, devices, fabrication and testing shall conform to the application codes, specifications and standards even though they are not specifically noted herein. Equivalent codes, specifications and standards established and approved in the country of equipment or material manufacture may be used subject to EGAT's approval. If this election is made, the Bidder shall so state and include in his bid the governing codes, specifications, and standards proposed together

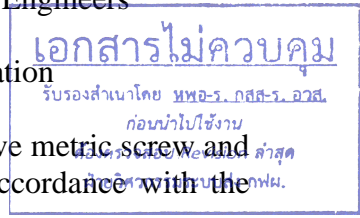

with an itemized list of specific deviations from the requirements of codes, specifications and standards referred herein.

The latest issue of all codes, specifications and standards shall govern.

The most stringent requirement, in the event of code, specification or standard conflict, shall govern. This specification shall govern in the event of discrepancies between it and applicable codes, specifications and standards.

## 741-5 Construction and Performance

### 741-5.1 Design and Constructions

- a. **General.** Each arrester shall be new and a current standard production model with modifications as may be required to satisfy the requirements stated herein.

The arresters shall conform to the applicable requirements of IEC 60099-4, except as stated herein or as shown on the accompanying Ratings and Features sheets.

Each arrester shall be station class metal oxide type without gaps and shall be self-supporting and base mounted for outdoor use, suitable for installation on either a steel supporting structure or a transformer/reactor tank, as specified in the price schedule. Each arrester shall be furnished completely with an insulating base and a cyclometer type-discharge counter with integral continuous AC leakage internal current indicator.

b. **Insulator.**

For porcelain insulator:

The surge arrester insulator shall be porcelain. Arrester insulator columns shall conform to the applicable requirements of IEC 62155, except as stated herein or as shown on the accompanying Ratings and Features sheet.

For polymer insulator:

The surge arresters shall be housed in an insulator formed from high temperature vulcanized (HTV) silicone. The final polymer compound after the addition of functional fillers shall contain at least 33% pure silicone rubber, together with a suitable proportion of ATH, but shall not contain any Ethylene Propylene (EP), Ethylene Vinyl Acetate (EVA) or other such UV sensitive materials. Details of the silicone supplier and generics of the final polymer compound shall be required and submitted together with the tender document during the bidding.

All arrester, insulator column steel parts shall be hot-dip galvanized after fabrication in accordance with the applicable provisions of ASTM A123 and A153. Threads shall be undercut an amount sufficient to allow for the galvanized coating. All

galvanizing shall be performed in accordance with the best modern practice.

- c. **Line Terminals.** Each equipment terminals for connecting to the line or other equipment shall be equipped with a suitable terminal pad unless otherwise specified. The terminal pad shall be provided with 14.3 mm (9/16 in) diameter holes with 45 mm (1-3/4 in) spacing between the centers of each hole in accordance with the NEMA Standards CC1, number of holes specified in Ratings and Features sheet.

The terminal pad shall be of high conductivity bronze, copper or aluminum alloy and, unless it is made of aluminum alloy, shall be plated with electro-tin to a thickness of not less than 0.0127 mm (0.0005 in).

- d. **Creepage Distance.** Each arrester shall have a minimum creepage distance as specified on the accompanying Ratings and Features sheet.

**741-5.2 Performance.** All surge arrester shall have the protective characteristics and arrester insulation withstand test voltage as specified in Rating and Features sheets. Arrester ratings shall conform to the applicable requirements of the latest standards and shall be consistent with the data and requirements stated herein and as shown on the accompanying Ratings and Features sheets.

- a. **Visible Corona.** Each arrester shall exhibit no visible corona in complete darkness when energized with a test voltage applied to its terminals equal to 1.05 times the maximum phase to ground continuous operating voltage.

- b. **Wind Load.** The 500kV surge arrester and supporting structure shall be designed to withstand wind with a velocity up to 125 km/h without damage to or impairment of operation of the equipment.

**741-6 Accessories**

- a. **Ground Connections.** Each arrester shall be furnished completely with a non-corroding clamp type ground connector suitable for No 4/0 AWG stranded copper conductor.

Arrester supporting structures, when specified, shall be provided with two grounding pads located approximately 300 mm above foot level and on diametrically opposite sides. Each grounding pad shall be flat and shall be provided with a clamp type connector for EGAT's No. 4/0 AWG stranded copper ground conductor.

No 4/0 AWG copper ground conductor connections between arresters and discharge counters shall be provided and shall be insulated, insulator supported to prevent conductor movement.

*Soravit Anuman*

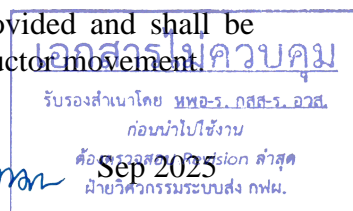

- b. Discharge Counter.** Discharge counters with AC leakage internal current indicator shall be of the cyclometer dial type for automatically recording the number of arrester surge discharges. The counter/indicator shall have negligible effect on arrester protective level. Discharge counter operation shall not require an external power source. Each discharge counter assembly shall include a suitable non-corroding arrester connector and a non-corroding clamp type ground connector suitable for No. 4/0 AWG stranded copper ground cable.

Discharge counters, whether frame supporting structure or transformer tank mounted, shall be mounted approximately 1.5 m above ground level.

- c. Marking and Nameplates.** Each arrester shall be provided with an attached identification nameplate or nameplates satisfying, but not limited to, the requirements of IEC 60099-4. The nameplate(s) shall include the EGAT contract number, item number, EGAT's serial number and total weight and be located to be readily legible from ground level. The nameplate(s) shall be black letters engraved on a background. All nameplate identification engraving shall be in English. Nameplate engraving shall be subject to EGAT approval.

All nameplates shall be anodized aluminum, stainless steel or other corrosion-resistant material and shall be attached with non-corroding screws or with non-corroding rivets.

**741-7**

**Supporting Structures.** Supporting structures, if specified in the Price Schedule, shall be fabricated of steel and be hot-dip galvanized after fabrication in accordance with ASTM A123, A153 and A53. All necessary galvanized bolts, nuts and washers required for complete structure assembly and erection, including foundation anchor bolts, shall be furnished including embedded anchor bolts for securing the supporting structures to the concrete foundation.

The galvanizing coating shall meet the values as shown in the following table.

**Galvanizing Coating Weight**

Description	Thickness	Coating Weight (g/m <sup>2</sup> )	
		Average Value	Minimum Value
Shaped steel and steel plate	6 mm and over	more than 702	more than 610
	under 6 mm	more than 610	more than 550
Steel pipe	-	more than 550	more than 490
Bolts, nuts	-	more than 381	more than 305
Washers, filters	5 mm and over	more than 381	more than 305
	under 5 mm	more than 305	more than 259

Finished materials shall be dipped into the solution of ~~dichromate~~ after galvanizing for white rust protection.

*Soravit Anuman*

**เอกสารไม่ควบคุม**  
 รับรองสำเนาโดย นพอ.ร. กสส-ร. อวส.  
 ก่อนนำไปใช้งาน  
 ต้องตรวจสอบ Division ล่าสุด  
 ฝ่ายวิศวกรรมระบบส่ง กฟผ.  
 Sep 2023

**Marking.** all individual pieces shall be marked with the correct designations shown on the approved shop drawings. Marking shall be done by die stamping the marks into the metal before galvanizing and shall be clearly legible after galvanizing. The number and letter shall be a minimum of 12 mm in height and 8 mm wide.

**741-8 Appliances & Tools.** The Contractor shall furnish all special appliances and tools that the arrester manufacturer deems necessary for satisfactory installation, operation, testing and maintenance of the arresters, including assembly and disassembly. Special tools and appliances shall be construed as those that are not readily available from appliance and tool suppliers in Thailand and those that the arrester manufacturer has procured or fabricated for use with the arresters or similar equipment. The Contractor shall submit to EGAT for approval a list of all appliances and tools required for above stated purposes and shall indicate thereon all appliances and tools.

**741-9 Test.** Test of equipment shall be performed according to the requirements specified in each referred test item. The costs of all tests and reports shall be borne by the Contractor.

**741-9.1 Type Test.** The proposed equipment shall already have the type test record of the same type and classification as EGAT called for, in accordance with the tests specified in test items, which is subject to EGAT's approval (unless otherwise specified in each equipment test item). In case of the same type of equipment as proposed has never been accepted by EGAT, the design test record shall be required and submitted together with the tender document during the bidding.

**741-9.2 Routine test.** Each equipment shall be completely assembled at the factory and subject to the tests specified in each test item.

**741-9.3 Test Report.** The report of all tests, curves and standard application data shall be furnished to EGAT immediately after completion of the tests.

**741-9.4 Test Procedure.** The Contractor shall submit the test procedure of routine tests and actual type tests to EGAT for approval. The test procedure shall consist of procedures, applied voltage, current and criteria to justify the result of the tests.

**741-9.5 Test Items for Metal Oxide Surge Arrester.** The tests shall be performed in accordance with the latest IEC standard as specified in Ratings and Features sheets.

**a. Type Tests**

- (a) Insulation withstand tests on the arrester housing.
- (b) Residual voltage test.
- (c) Test to verify long term stability under continuous operating voltage.
- (d) Repetitive charge transfer withstand.

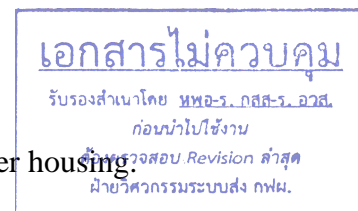

24 กุมภาพันธ์ 2569

- (e) Heat dissipation behaviour verification of test sample.
- (f) Operating duty test.
- (g) Power-frequency voltage versus time.
- (h) Arrester disconnector/fault indicator. (when fitted)
- (i) Short-circuit tests.
- (j) Bending moment.
- (k) Environmental tests.
- (l) Seal leak rate.
- (m) Radio interference voltage. (RIV)
- (n) Test to verify the dielectric withstand of the internal components of an arrester.
- (o) Test of internal grading components.
- (p) Weather ageing test.
- (q) Seismic capability verification. (as required on accompanying Rating and Feature sheet)

#### **b. Routine Tests**

- (a) Measurement of reference voltage.
- (b) Residual voltage test.
- (c) Internal partial discharge test.
- (d) The power-frequency voltage.
- (e) Seal leak rate.
- (f) Current distribution test. (for multi-column arrester)
- (g) Proper assembly of each disconnector. (when fitted).
- (h) Creepage distance measurement. One unit of each type and rating shall be subject to this test. This test may be omitted if a test record of an identical unit can be verified.

**เอกสารไม่ควบคุม**  
 รับรองสำเนาโดย นพอ.ร. กสส.ร. อวส.  
 ก่อนนำไปใช้งาน  
 ต้องตรวจสอบ Revision ล่าสุด  
 ฝ่ายวิศวกรรมระบบส่ง กฟผ.

**741-10 Drawings and Documents for Metal Oxide Surge Arrester**

Drawings and documents shall at least comprise the following:

**A. Drawings**

Item	Description	Approval and Final Dwgs	Autocad files	CD-ROM or Other Storage Device
1	Outline drawing including electrical and protective characteristics	X	X	X
2	Nameplate including ratings, EGAT's Contract No., Item No. and EGAT Serial No.	X	X	X
3	Insulating base showing dimensions and mounting details	X	-	X
4	Line terminal pad	X	-	X
5	Ground terminal connector	X	-	X
6	Discharge counter with leakage current detector outline	X	-	X
7	Discharge counter with leakage current detector schematic diagram	X	-	X
8	Connection between arrester discharge counter and leakage current detector	X	-	X
9	Grading ring location and dimensions (if any)	X	-	X
10	Characteristic of each rating surge arrester	X	-	X
11	Steel supporting structure (if any)	X	X	X
12	Assembly drawing of each arrester assembly and supporting structure	X	X	X

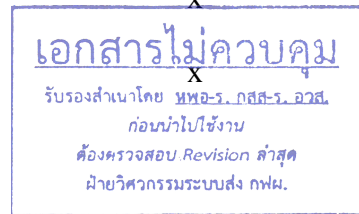

**B. Drawing and Documents for Reference.**

1. Cross Section view with component part identification by description and by part or catalog number.
2. Discharge counter with leakage current detector.

3. Curves for each arrester rating showing the following characteristics as determined by tests.
  - a. Temporary overvoltage capability at 50 Hz at ambient temperatures of 60°C.
  - b. Discharge voltage-time characteristics.

#### 741-11 Instruction Manual for Metal Oxide Surge Arrester

Instruction manual shall consist of all necessary information and shall comprise at least the following parts:

- Part A** Surge arrester instruction including installation, operation and maintenance.
- a. Surge arrester general technical information
  - b. Installation instruction including but not limit to
    - Transportation
    - Inspection
    - Installation instruction
    - Handling and damage claim instructions (if any)
  - c. Operation and maintenance
    - Storage
    - Routine inspection
    - Maintenance
    - Assembly and disassembly instructions including a complete list of required tools (if any)
  - d. Catalog
- Part B** Complete set of all final drawing and/or documents arranged in order of each complete item.

**เอกสารไม่ควบคุม**

รับรองสำเนาโดย ทพอ.ร. กสส.ร. อวส.

ก่อนนำไปใช้งาน

ต้องตรวจสอบ Revision สำสุด

ฝ่ายวิศวกรรมระบบส่ง กฟผ.

24 กุมภาพันธ์ 2569

**DRAFT**

**SECTION J  
DRAWINGS**

**J. DRAWINGS**

**J-1. Drawings**

The following drawings are attached hereto and made a part of the Contract Documents:

No.	Description	Dwg. No.	Sheet	Rev.
1	FOUR-500/230 KV TRANSFORMER BANK PARALLEL OPERATION TYPICAL SCHEMATIC DIAGRAM	TP-E-10.12	1/2	-
2	FOUR-500/230 KV TRANSFORMER BANK PARALLEL OPERATION TYPICAL SCHEMATIC DIAGRAM	TP-E-10.12	2/2	-

DRAFT

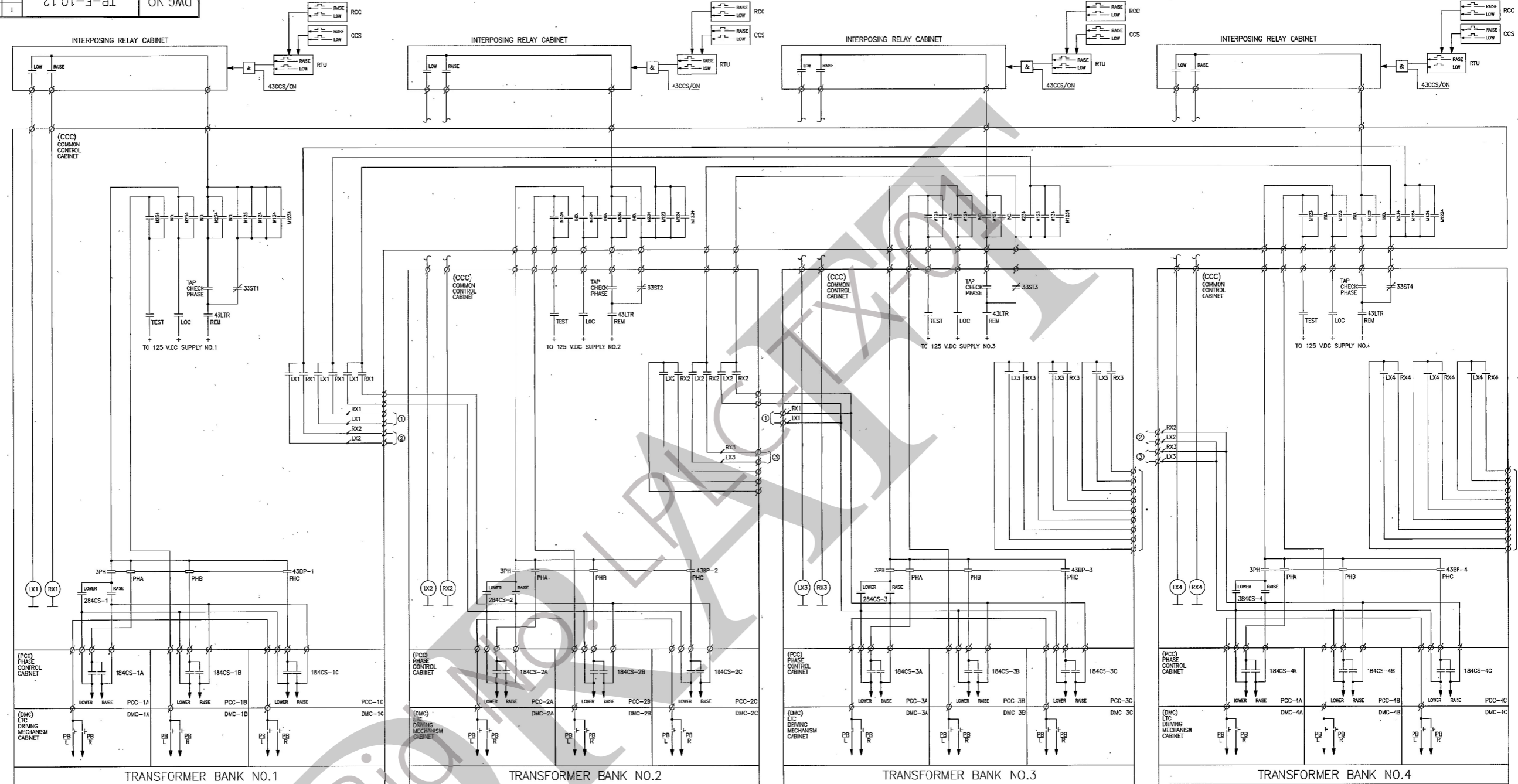

- LEGEND**
- 43SP "IND-M1234-M234-M134-M123" SELECTOR SWITCH
  - 43LIR-1,2,3,4 "LOCAL-TEST-REMOTE" SELECTOR SWITCH
  - 43BP-1,2,3,4 "3PH-PHA-PHB-PHC" SELECTOR SWITCH
  - 184CS-1,2,3,4 "LOWER-RAISE" CONTROL SWITCH
  - 284CS-1,2,3,4 "LOWER-RAISE" CONTROL SWITCH
  - RX-1,2,3,4 LX-1,2,3,4
  - PB PUSHBUTTON SWITCH FOR RAISE OR LOWER

- LOCATION**
- CCC (CCC) COMMON CONTROL CABINET
  - PCC (PCC) PHASE CONTROL CABINET
  - DMC (DMC) LTC DRIVING MECHANISM CABINET
- NOTE**
1. CCC : COMMON CONTROL CABINET
  2. THIS SCHEMATIC DIAGRAM IS INTENDED TO SHOW FUNCTIONAL CONTROL REQUIREMENTS ONLY, ACTUAL SCHEMATIC DIAGRAMS SHALL BE DESIGNED BY THE MANUFACTURER.
  3. SWITCH POSITION SHOWN BELOW SWITCH DEVICE DESIGNATION INDICATES SWITCH POSITION IN WHICH ITS CONTACT IS CLOSED.
  4. 43SP SELECTOR SWITCH SHALL BE PROVIDED AND SHALL HAVE THE FOLLOWING SWITCH POSITIONS.
- IND : EACH BANK OF TRANSFORMER IS INDIVIDUALLY OPERATED
- M1234 : TRANSFORMER BANK NO.1 IS OPERATED AS MASTER, TRANSFORMER BANK NO.2,3 & 4 ARE OPERATED AS FOLLOWERS
  - M234 : TRANSFORMER BANK NO.2 IS OPERATED AS MASTER, TRANSFORMER BANK NO.3 & 4 ARE OPERATED AS FOLLOWERS, TRANSFORMER BANK NO.1 IS INDIVIDUALLY OPERATED.
  - M134 : TRANSFORMER BANK NO.1 IS OPERATED AS MASTER, TRANSFORMER BANK NO.3 & 4 ARE OPERATED AS FOLLOWERS, TRANSFORMER BANK NO.2 IS INDIVIDUALLY OPERATED.
  - M124 : TRANSFORMER BANK NO.1 IS OPERATED AS MASTER, TRANSFORMER BANK NO.2 & 4 ARE OPERATED AS FOLLOWERS, TRANSFORMER BANK NO.3 IS INDIVIDUALLY OPERATED.
  - M123 : TRANSFORMER BANK NO.1 IS OPERATED AS MASTER, TRANSFORMER BANK NO.2 & 3 ARE OPERATED AS FOLLOWERS, TRANSFORMER BANK NO.4 IS INDIVIDUALLY OPERATED.
- \* FACILITATE TRANSFORMER RELOCATION

**เอกสารไม่ควบคุม**  
รับรองสำเนาโดย พ.ท.ร. กฤษ. ร.อ.ส.  
ก่อนนำไปใช้งาน  
ต้องตรวจสอบ Revision ล่าสุด  
ฝ่ายวิศวกรรมระบบส่ง กฟผ.  
24 กุมภาพันธ์ 2567

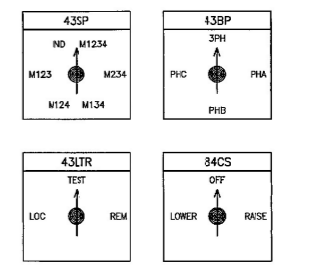

REV. NO.	JOB NO.	JOB DESCRIPTION	DRAWN	DESIGNED	VERIFIED	VALIDATED	RECOMMENDED	CONCURRED	APPROVED	DATE
1		NEW TYPICAL DRAWING.	W.Natthapong							

ELECTRICITY GENERATING AUTHORITY OF THAILAND											
DRAWN	W.Natthapong	VALIDATED	[Signature]							DRAWING NAME	TYPICAL DRAWING
DESIGNED	W.Natthapong	RECOMMENDED	[Signature]							DESCRIPTION OF DETAIL DRAWING	FOUR-500/230 KV TRANSFORMER BANK PARALLEL OPERATION TYPICAL SCHEMATIC DIAGRAM
VERIFIED	P. Pim	CONCURRED	[Signature]							JOB NO.	
APPROVED	J. U	DATE		17/02/08		REPLACING DWG. NO.		DWG. NO.		TP-E-10.12	
ASSISTANT GOVERNOR - TRANSMISSION SYSTEM ENGINEERING											

DO NOT AMEND MANUALLY

CABINET NO. 101  
REV. NO. 1540

